

Plug-in connector - SACC-FR-5SC SH SCO - 1432677

Please be informed that the data shown in this PDF Document is generated from our Online Catalog. Please find the complete data in the user's documentation. Our General Terms of Use for Downloads are valid (<http://download.phoenixcontact.com>)

Sensor/actuator connector, socket, angled, 5-pos., M12 SPEEDCON, shielded, A-coded, spring-cage connection, metal knurl, cable diameter max. 8 mm



Product Features

- ✓ Safe use in the field, thanks to a high degree of protection
- ✓ Flexible: plug-in connectors for on-site assembly
- ✓ Save time, thanks to installation with SPEEDCON rapid interlock system
- ✓ Spring-cage connection: connect more securely, even in the case of shock and vibration, thanks to high contact forces
- ✓ Reliable signal transmission - 360° shielding in environments with electromagnetic interference



Key commercial data

Packing unit	1 PCE
Catalog page	Page 72 (PC-2011)
GTIN	 4 046356 348362
Custom tariff number	85366990
Country of origin	GERMANY

Technical data

General data

Rated current at 40°C	4 A
Rated voltage	60 V
Number of positions	5
Volume resistance	≤ 8 mΩ
Insulation resistance	≥ 100 MΩ
Ambient temperature (operation)	-40 °C ... 85 °C (Plug / socket)

Plug-in connector - SACC-FR-5SC SH SCO - 1432677

Technical data

General characteristics

Standards/regulations	M12 plug-in connector IEC 61076-2-101
Coding	A - standard
Surge voltage category	II
Pollution degree	3
Degree of protection	IP65/67
Insertion/withdrawal cycles	≥ 100
Torque	0.4 Nm (M12 knurl)
Torque	0.8 Nm (Connector with coupling sleeve)
Torque	3 Nm (Pressure nut with coupling sleeve)
Contact material	CuSn
Contact surface material	Ni/Au
Contact carrier material	TPU
Material of grip body	Zinc die-cast, nickel-plated
Material, knurls	Nickel-plated brass
Sealing material	NBR
Connection method	Spring-cage conn.
Conductor cross section	0.14 mm ² ... 0.5 mm ²
AWG conductor cross section	26 ... 20
Assembly instructions	AWG 18 wire cross section upon request
External cable diameter	4 mm ... 8 mm
Status display	No
Stripping length of the sheath	35 mm
Stripping length of the individual wire	11 mm

Classifications

ETIM

ETIM 3.0	EC001855
ETIM 4.0	EC002062
ETIM 5.0	EC002062

UNSPSC

UNSPSC 11	31251501
UNSPSC 12.01	31251501
UNSPSC 13.2	31251501
UNSPSC 6.01	31251501
UNSPSC 7.0901	31251501

Plug-in connector - SACC-FR-5SC SH SCO - 1432677

Classifications

eCl@ss

eCl@ss 4.0	27250313
eCl@ss 4.1	27250313
eCl@ss 5.0	27143423
eCl@ss 5.1	27143423
eCl@ss 6.0	27143423
eCl@ss 7.0	27449001

Approvals

Approvals

Approvals

UL Recognized / cUL Recognized / GOST / cULus Recognized

Ex Approvals

Approvals submitted

Approval details

UL Recognized 	
Nominal current IN	4 A
Nominal voltage UN	125 V

cUL Recognized 	
Nominal current IN	4 A
Nominal voltage UN	125 V

Plug-in connector - SACC-FR-5SC SH SCO - 1432677

Approvals

GOST 

cULus Recognized 

Accessories

Accessories

Cable/conductor

Sensor/Actuator cable - SAC-5P-100,0-PUR/SH-0,34 - 1501728



Cable ring, PUR halogen-free black, 5-pos., shielded, conductor colors: Brown/white/blue/black/gray, cable length: 100 m

Protection and sealing elements

Screw plug - PROT-M12 MS-PA-CHAIN - 1430899

M12 sealing cap with fixing band, for sensor cables, for free M12 sockets



Tools

Torque screwdriver - TSD 04 SAC - 1208429



Torque screwdriver, with preset torque of 0.4 Nm and 4 mm hexagonal drive for M12 connectors

Plug-in connector - SACC-FR-5SC SH SCO - 1432677

Accessories

Torque screwdriver - TSD 08 SAC - 1212597



Torque screw driver with preset torque of 0.8 Nm, with 4 mm hexagon for accommodating SAC bits, two-component handle with non-slip grip

Tool - SACC BIT M12-D20 - 1208445



Nut for assembling SACC M12 connectors for free assembly, excluding M12 connectors with QUICKON fast connection technology, for 4 mm hexagonal drive

Torque screwdriver - TSD-M 1,2NM - 1212224



Torque screw driver, accuracy as per EN ISO 6789 standard, adjustable from 0.3 - 1.2 Nm

Torque screwdriver - TSD-M 3NM - 1212225



Torque screw driver, accuracy as per EN ISO 6789 standard, adjustable from 1.2 - 3 Nm

Adapter insert - TSD-M SAC-BIT ADAPTER - 1212600



Adapter bit for TSD-M...torque tools, E6.3-1/4" drive with 4 mm hexagon to accommodate SAC bits

Plug-in connector - SACC-FR-5SC SH SCO - 1432677

Accessories

Shielding foil - ALU-SB - 1404531

Aluminum shielding tape, for fixing the braided shield of shielded cables. Length: 4 cm, width: 1.2 cm



Drawings

Schematic diagram

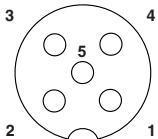

Pin assignment M12 socket, 5-pos., A-coded, socket side view

Dimensioned drawing

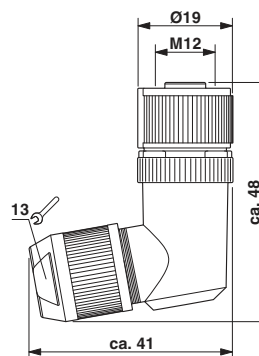

Socket M12-SPEEDCON, angled, shielded

Plug-in connector - SACC-FR-5SC SH SCO - 1432677

Functional drawing

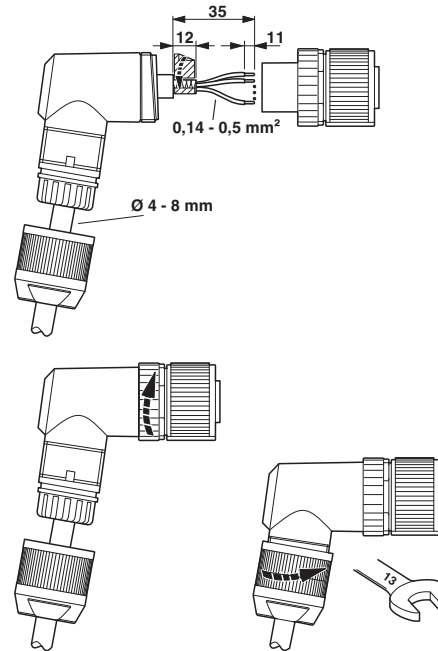

Strip the cable, shorten the shield, strip the single wires, push the pressure nut onto the cable. Slide the wires through the sleeve housing and connect, stick shielding foil around the shortened shield, in the case of straight sleeve housing, gently twist the wires together, screw sleeve housing to the plug insert, screw the pressure nut tight.