

917686-1 ✓ ACTIVE

AMP Signal Double Lock

TE Internal #: 917686-1

Housing, Plug, Wire-to-Wire, 2 Position, .098 in [2.5 mm] Centerline, Crimp, 1 Row, Natural, Mating Retention, Wire & Cable, AMP Signal Double Lock

[View on TE.com >](#)



Connectors > PCB Connectors > Wire-to-Board Connectors > Wire-to-Board Connector Assemblies & Housings >

STD Temp Signal Double Lock Plug

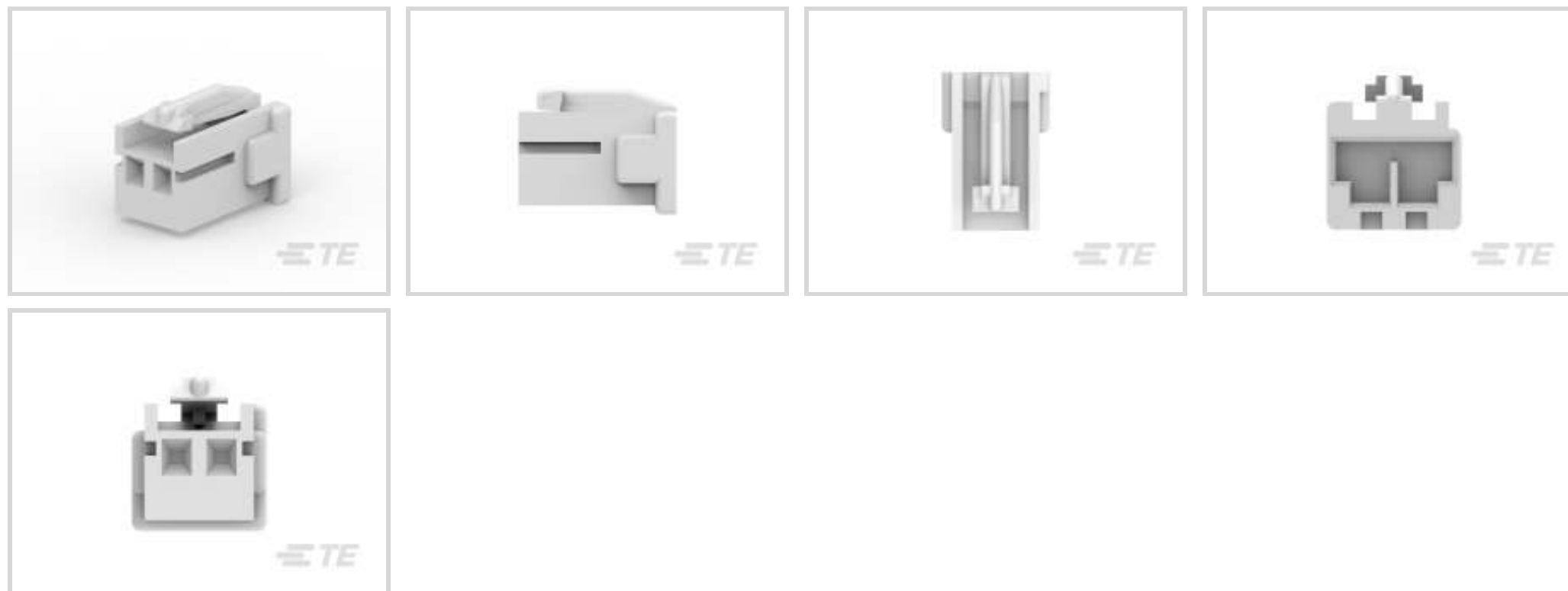

Connector Product Type: **Housing**

Connector & Housing Type: **Plug**

Connector System: **Wire-to-Wire**

Number of Positions: **2**

Centerline (Pitch): **2.5 mm [.098 in]**

[All STD Temp Signal Double Lock Plug \(35\)](#)

Features

Product Type Features

Connector Product Type	Housing
Connector & Housing Type	Plug
Connector System	Wire-to-Wire
Sealable	No
Connector & Contact Terminates To	Wire & Cable

Configuration Features

Number of Positions	2
Number of Rows	1

Electrical Characteristics

Operating Voltage	250 VAC
-------------------	---------

Body Features

--	--



Primary Product Color	Natural
-----------------------	---------

Contact Features

Contact Layout	Inline
----------------	--------

Contact Type	Socket
--------------	--------

Contact Current Rating (Max)	3 A
------------------------------	-----

Termination Features

Termination Method to Wire & Cable	Crimp
------------------------------------	-------

Mechanical Attachment

Strain Relief	Without
---------------	---------

Mating Retention Type	Latch
-----------------------	-------

Mating Retention	With
------------------	------

Connector Mounting Type	Cable Mount (Free-Hanging)
-------------------------	----------------------------

Housing Features

Housing Material	Nylon 6/6
------------------	-----------

Centerline (Pitch)	2.5 mm [.098 in]
--------------------	------------------

Dimensions

	7.5 in
--	--------

Wire Size	.326 – .518 mm ²
-----------	-----------------------------

Usage Conditions

Operating Temperature Range	-30 – 105 °C [-22 – 221 °F]
-----------------------------	-----------------------------

Operation/Application

Circuit Application	Power & Signal
---------------------	----------------

Industry Standards

Glow Wire Rating	Standard Part - Not Glow Wire
------------------	-------------------------------

UL Flammability Rating	UL 94V-0
------------------------	----------

Packaging Features

Packaging Quantity	600
--------------------	-----

Packaging Method	Bag & Box
------------------	-----------

Product Compliance

[For compliance documentation, visit the product page on TE.com>](#)



EU RoHS Directive 2011/65/EU	Compliant
EU ELV Directive 2000/53/EC	Compliant
China RoHS 2 Directive MIIT Order No 32, 2016	No Restricted Materials Above Threshold
EU REACH Regulation (EC) No. 1907/2006	Current ECHA Candidate List: JUNE 2023 (235) Candidate List Declared Against: JAN 2023 (233) Does not contain REACH SVHC
Halogen Content	Low Halogen - Br, Cl, F, I < 900 ppm per homogenous material. Also BFR/CFR/PVC Free
Solder Process Capability	Not applicable for solder process capability

Product Compliance Disclaimer

This information is provided based on reasonable inquiry of our suppliers and represents our current actual knowledge based on the information they provided. This information is subject to change. The part numbers that TE has identified as EU RoHS compliant have a maximum concentration of 0.1% by weight in homogenous materials for lead, hexavalent chromium, mercury, PBB, PBDE, DBP, BBP, DEHP, DIBP, and 0.01% for cadmium, or qualify for an exemption to these limits as defined in the Annexes of Directive 2011/65/EU (RoHS2). Finished electrical and electronic equipment products will be CE marked as required by Directive 2011/65/EU. Components may not be CE marked. Additionally, the part numbers that TE has identified as EU ELV compliant have a maximum concentration of 0.1% by weight in homogenous materials for lead, hexavalent chromium, and mercury, and 0.01% for cadmium, or qualify for an exemption to these limits as defined in the Annexes of Directive 2000/53/EC (ELV). Regarding the REACH Regulation, the information TE provides on SVHC in articles for this part number is based on the latest European Chemicals Agency (ECHA) 'Guidance on requirements for substances in articles' posted at this URL: <https://echa.europa.eu/guidance-documents/guidance-on-reach>

Compatible Parts

 <p>TE Part # CAT-SI261-C1701 STD Temp Signal Double Lock Cap</p>	 <p>TE Part # CAT-SI261-R2435 Signal Double Lock Receptacle</p>	 <p>TE Part # 2108504-1 2.5 SDL 18P PLUG HSG 2ROW</p>	 <p>TE Part # 917780-1 2.5 S.D.L POST HDR ASY 2P STD</p>
 <p>TE Part # 2-917780-1 2.5 S.D.L POST HDR ASY 2P STD</p>	 <p>TE Part # 917894-1 2.5 S.D.L STD V 2P HDR ON/TAPE</p>	 <p>TE Part # 917722-1 2.5 SIGNAL D/LOCK HDR ASSY 2P</p>	 <p>TE Part # 316221-1 2.5S.D.L HI-PRO V 2P ON/TAPE</p>



Also in the Series | AMP Signal Double Lock

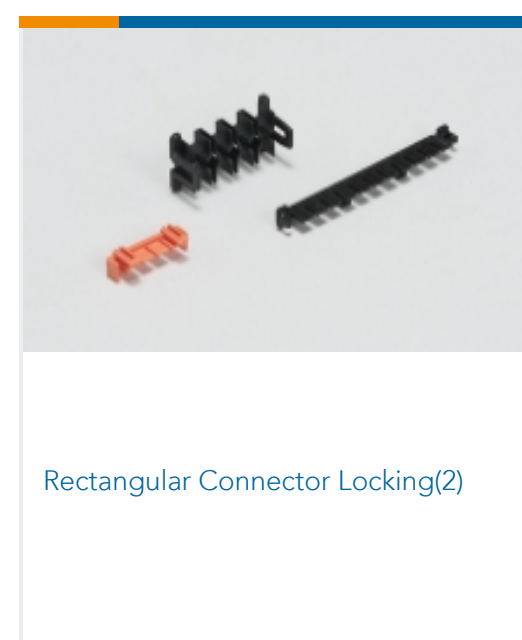
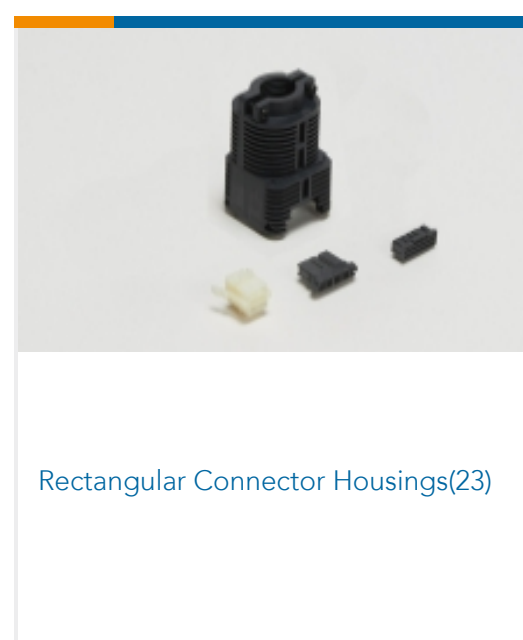
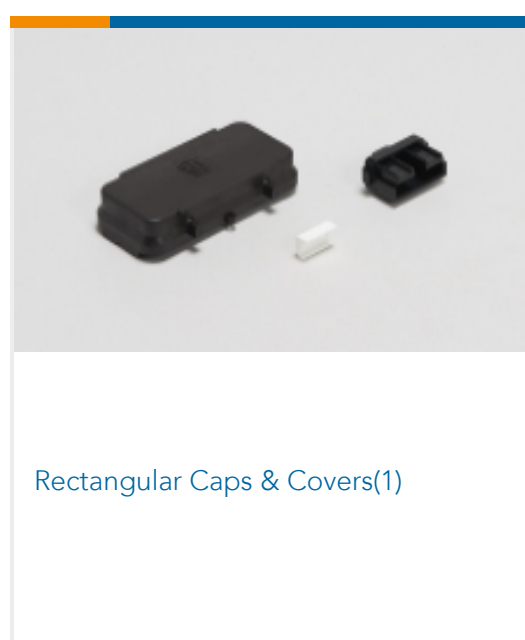
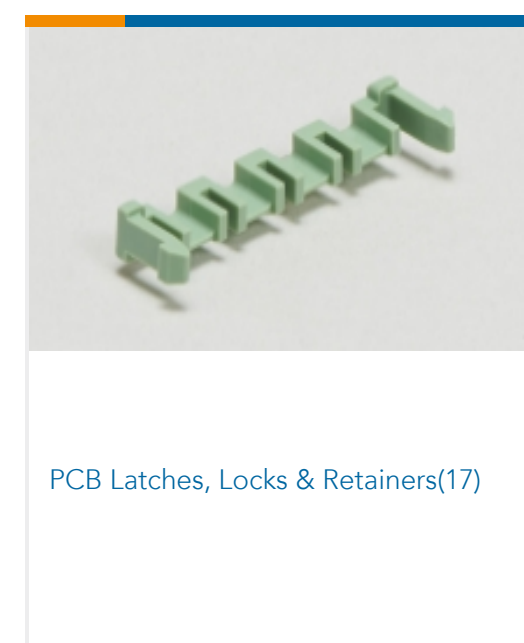
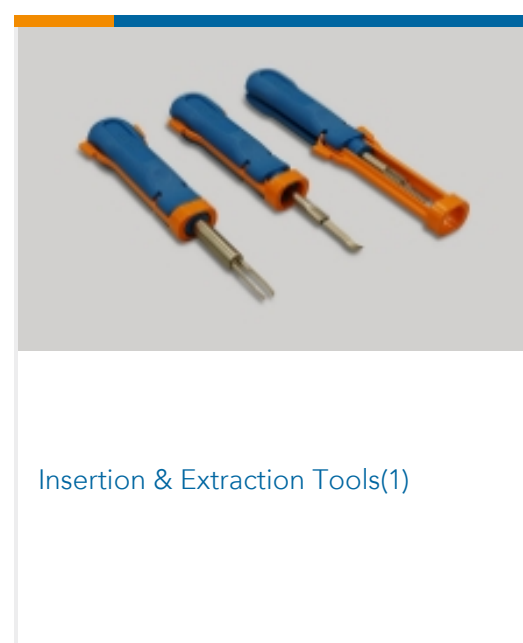
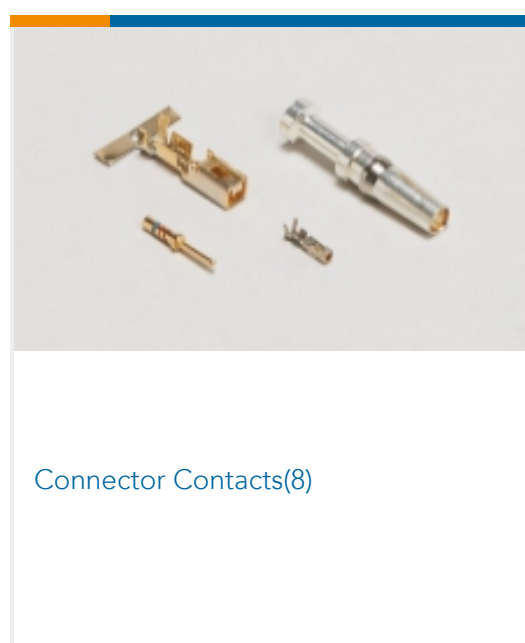



Rectangular Power Connectors(3)

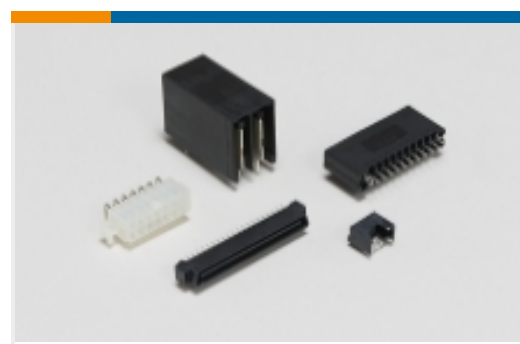

Standard Rectangular Connectors(1)

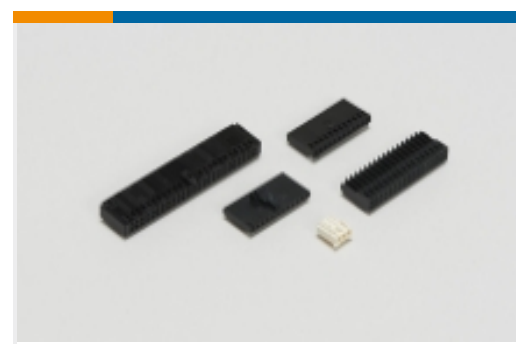

Wire-to-Board Connector Assemblies & Housings(76)



Wire-to-Board Connector Contacts(6)

Customers Also Bought

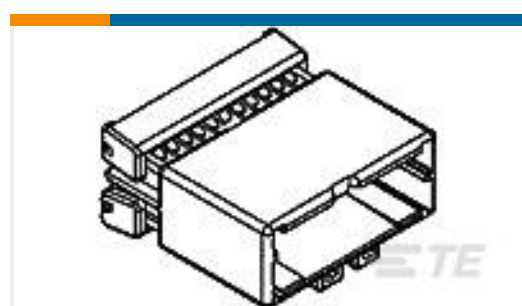
TE Part #917690-1
STD Temp Signal Double Lock PlugTE Part #316090-1
STD Temp Signal Double Lock CapTE Part #917765-1
2.5 SIGNAL D/LOCK TAB CONT. MTE Part #917706-1
2.5 SIGNAL DBL LOCK DLP 10PTE Part #1123350-1
040-3 MLC CAP HSG ASSY 16P

Documents

Product Drawings

[2.5 SIGNAL D/LOCK PLUG HSG 2P](#)

English

CAD Files

[3D PDF](#)

3D

Customer View Model

[ENG_CVM_CVM_917686-1_M.2d_dxf.zip](#)

English

Customer View Model

[ENG_CVM_CVM_917686-1_M.3d_igs.zip](#)

English

Customer View Model

[ENG_CVM_CVM_917686-1_M.3d_stp.zip](#)

English

By downloading the CAD file I accept and agree to the [Terms and Conditions](#) of use.



Datasheets & Catalog Pages

[SOFT_SHELL_PIN_AND_SOCKET_CONNECTORS_CATALOG](#)

English

[1773458-3_2.5MM_SIGNAL_DOUBLE_LOCK_CONNECTORS](#)

English

Product Environmental Compliance

[MD_917686-1_061120181021_dmtec](#)

English

[MD_917686-1_061120181021_dmtec](#)

English

Agency Approvals

[CSA Certificate](#)

English

[CSA Certificate](#)

English