

CMOS Presettable Up/Down Counters (Dual Clock With Reset)

High-Voltage Types (20-Volt Rating)

CD40192 – BCD Type

CD40193 – Binary Type

■ CD40192B Presettable BCD Up/Down Counter and the CD40193B Presettable Binary Up/Down Counter each consist of 4 synchronously clocked, gated "D" type flip-flops connected as a counter. The inputs consist of 4 individual jam lines, a PRESET ENABLE control, individual CLOCK UP and CLOCK DOWN signals and a master RESET. Four buffered Q signal outputs as well as CARRY and BORROW outputs for multiple-stage counting schemes are provided.

The counter is cleared so that all outputs are in a low state by a high on the RESET line. A RESET is accomplished asynchronously with the clock. Each output is individually programmable asynchronously with the clock to the level on the corresponding jam input when the PRESET ENABLE control is low.

The counter counts up one count on the positive clock edge of the CLOCK UP signal provided the CLOCK DOWN line is high. The counter counts down one count on the positive clock edge of the CLOCK DOWN signal provided the CLOCK UP line is high.

The CARRY and BORROW signals are high when the counter is counting up or down. The CARRY signal goes low one-half clock cycle after the counter reaches its maximum count in the count-up mode. The BORROW signal goes low one-half clock cycle after the counter reaches its minimum count in the count-down mode. Cascading of multiple packages is easily accomplished without the need for additional external circuitry by tying the BORROW and CARRY outputs to the CLOCK DOWN and CLOCK UP inputs, respectively, of the succeeding counter package.

The CD40192B and CD40193B types are supplied in 16-lead hermetic dual-in-line ceramic packages (D and F suffixes), 16-lead dual-in-line plastic packages (E suffix), and in chip form (H suffix).

Features:

- Individual clock lines for counting up or counting down
- Synchronous high-speed carry and borrow propagation delays for cascading
- Asynchronous reset and preset capability
- Medium-speed operation— $f_{CL} = 8 \text{ MHz (typ.) @ } 10 \text{ V}$
- 5-V, 10-V, and 15-V parametric ratings
- Standardized, symmetrical output characteristics
- 100% tested for quiescent current at 20 V
- Maximum input current of $1 \mu\text{A}$ at 18 V over full package temperature range; 100 nA at 18 V and 25°C
- Noise margin over full package temperature range:
 - 1 V at $V_{DD} = 5 \text{ V}$ 2 V at $V_{DD} = 10 \text{ V}$
 - 2.5 V at $V_{DD} = 15 \text{ V}$

- Meets all requirements of JEDEC Tentative Standard No. 13B, "Standard Specifications for Description of 'B' Series CMOS Devices"

Applications:

- Up/down difference counting
- Multistage ripple counting
- Synchronous frequency dividers
- A/D and D/A conversion
- Programmable binary or BCD counting

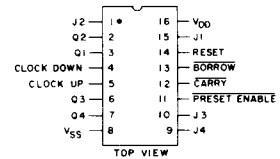
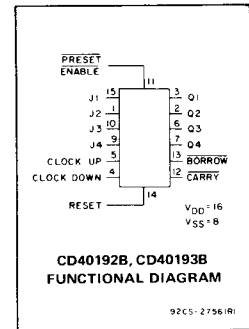

CD40192B, CD40193B
TERMINAL ASSIGNMENT

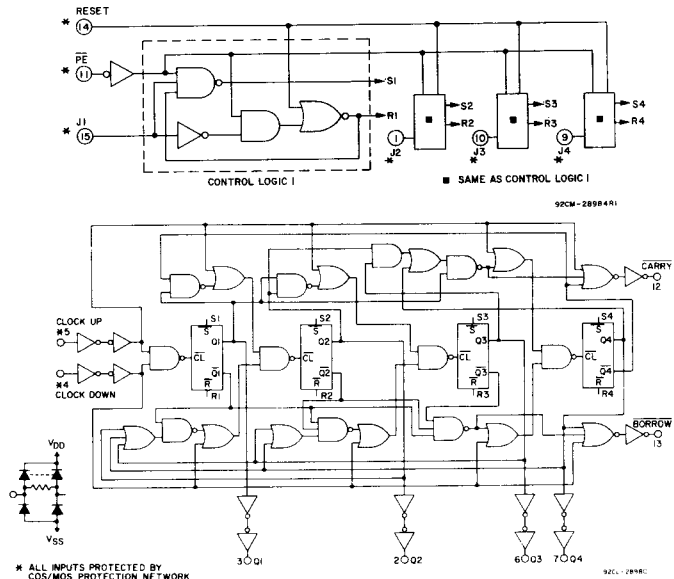

Fig. 1 — CD40192B logic diagram (BCD).

CD40192B, CD40193B Types

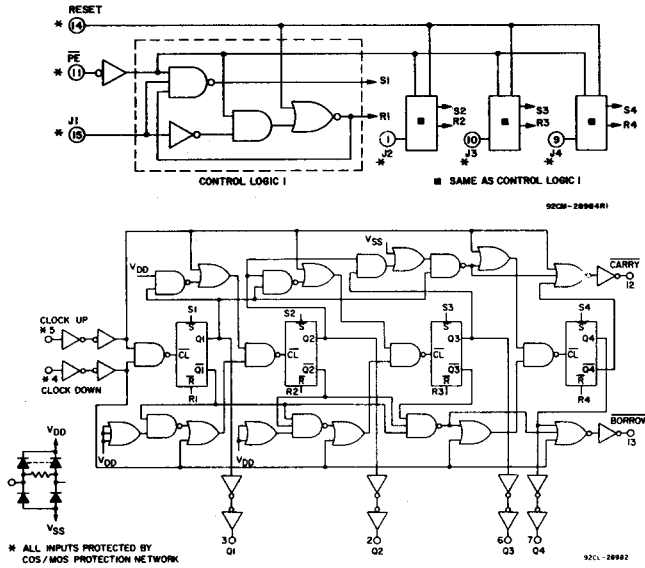

Fig. 2 - CD40193B logic diagram (binary).

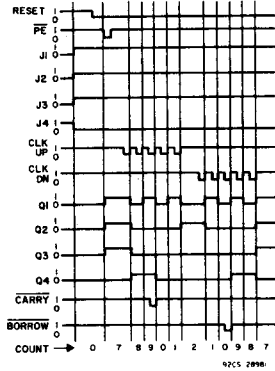

Fig. 3 - CD40192B timing diagram.

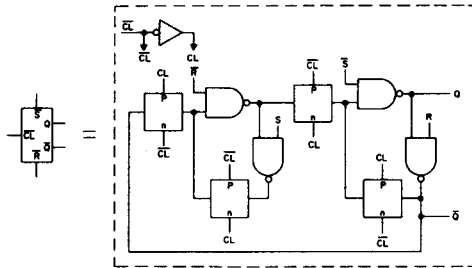

Fig. 4 - Internal logic of Flip-flop.

TRUTH TABLE

CLOCK UP	CLOCK DOWN	PRESET ENABLE	RESET	ACTION
	1	1	0	COUNT UP
	1	1	0	NO COUNT
1		1	0	COUNT DOWN
1		1	0	NO COUNT
X	X	0	0	PRESET
X	X	X	1	RESET

1 = HIGH LEVEL

0 = LOW LEVEL

X = DON'T CARE

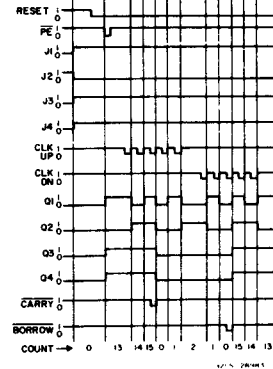

Fig. 5 - CD40193B timing diagram.

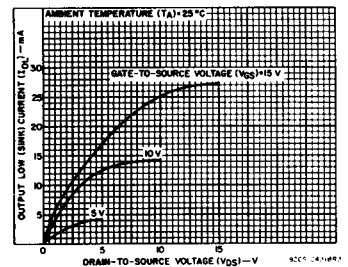

Fig. 6 - Typical output low (sink) current characteristics.

3
 COMMERCIAL CMOS
 HIGH VOLTAGE ICs

CD40192B, CD40193B Types

MAXIMUM RATINGS, Absolute-Maximum Values:

DC SUPPLY-VOLTAGE RANGE, (V_{DD})
 Voltages referenced to V_{SS} Terminal) -0.5V to +20V
 INPUT VOLTAGE RANGE, ALL INPUTS -0.5V to $V_{DD} + 0.5V$
 DC INPUT CURRENT, ANY ONE INPUT $\pm 10\text{mA}$
 POWER DISSIPATION PER PACKAGE (P_D):
 For $T_A = -55^\circ\text{C}$ to $+100^\circ\text{C}$ 500mW
 For $T_A = +100^\circ\text{C}$ to $+125^\circ\text{C}$ Derate Linearly at $12\text{mW}/^\circ\text{C}$ to 200mW
 DEVICE DISSIPATION PER OUTPUT TRANSISTOR
 FOR $T_A = \text{FULL PACKAGE-TEMPERATURE RANGE (All Package Types)}$ 100mW
 OPERATING-TEMPERATURE RANGE (T_A) -55°C to $+125^\circ\text{C}$
 STORAGE TEMPERATURE RANGE (T_{stg}) -65°C to $+150^\circ\text{C}$
 LEAD TEMPERATURE (DURING SOLDERING):
 At distance $1/16 \pm 1/32$ inch ($1.59 \pm 0.79\text{mm}$) from case for 10s max $+265^\circ\text{C}$

RECOMMENDED OPERATING CONDITIONS at $T_A = 25^\circ\text{C}$ (unless otherwise specified)

For maximum reliability, nominal operating conditions should be selected so that operation is always within the following ranges.

CHARACTERISTIC	V_{DD} (V)	LIMITS		UNITS
		Min.	Max.	
Supply Voltage Range (For $T_A = \text{Full Temp. Range}$)	-	3	18	V
Removal Time: RESET or \overline{PE}	5	80	-	ns
	10	40	-	
	15	30	-	
Pulse Width: RESET	5	480	-	ns
	10	300	-	
	15	260	-	
\overline{PE}	5	240	-	ns
	10	170	-	
	15	140	-	
CLOCK	5	180	-	ns
	10	90	-	
	15	60	-	
Clock Input Frequency	5	DC	2	MHz
	10	DC	4	
	15	DC	5.5	
Clock Rise & Fall Time	5	-	15	μs
	10	-	15	
	15	-	5	

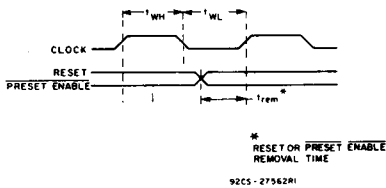

Fig. 10 — Timing diagram defining t_{rem}

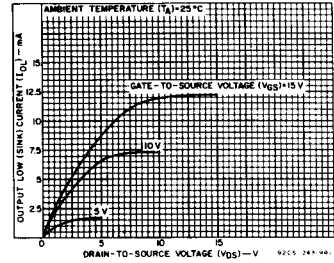

Fig. 7 — Minimum output low (sink) current characteristics.

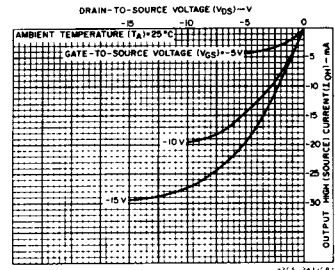

Fig. 8 — Typical output high (source) current characteristics.

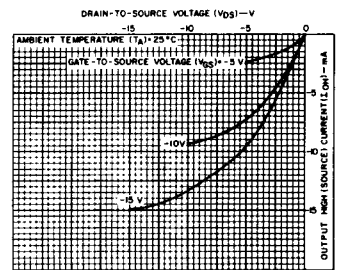

Fig. 9 — Minimum output high (source) current characteristics.

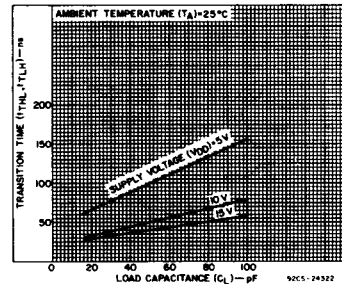

Fig. 11 — Typical transition time as a function of load capacitance.

CD40192B, CD40193B Types

STATIC ELECTRICAL CHARACTERISTICS

CHARACTERISTIC	CONDITIONS			LIMITS AT INDICATED TEMPERATURES (°C)						UNITS	
	V _O (V)	V _{IN} (V)	V _{DD} (V)	-55			+25				
				Min.	Typ.	Max.	Min.	Typ.	Max.		
Quiescent Device Current, I _{DD} Max.	-	0.5	5	5	5	150	150	-	0.04	5	μA
	-	0.10	10	10	10	300	300	-	0.04	10	
	-	0.15	15	20	20	600	600	-	0.04	20	
	-	0.20	20	100	100	3000	3000	-	0.08	100	
Output Low (Sink) Current I _{OL} Min.	0.4	0.5	5	0.64	0.61	0.42	0.36	0.51	1	-	mA
	0.5	0.10	10	1.6	1.5	1.1	0.9	1.3	2.6	-	
	1.5	0.15	15	4.2	4	2.8	2.4	3.4	6.8	-	
Output High (Source) Current, I _{OH} Min.	4.6	0.5	5	-0.64	-0.61	-0.42	-0.36	-0.51	-1	-	mA
	2.5	0.5	5	-2	-1.8	-1.3	-1.15	-1.6	-3.2	-	
	9.5	0.10	10	-1.6	-1.5	-1.1	-0.9	-1.3	-2.6	-	
	13.5	0.15	15	-4.2	-4	-2.8	-2.4	-3.4	-6.8	-	
Output Voltage: Low-Level, V _{OL} Max.	-	0.5	5	0.05			0			0.05	V
	-	0.10	10	0.05			-			0	
	-	0.15	15	0.05			-			0	
Output Voltage: High-Level, V _{OH} Min.	-	0.5	5	4.95			4.95			5	V
	-	0.10	10	9.95			9.95			10	
	-	0.15	15	14.95			14.95			15	
Input Low Voltage, V _{IL} Max.	0.5, 4.5	-	5	1.5			-			1.5	V
	1, 9	-	10	3			-			3	
	1.5, 13.5	-	15	4			-			4	
Input High Voltage, V _{IH} Min.	0.5, 4.5	-	5	3.5			3.5			-	V
	1, 9	-	10	7			7			-	
	1.5, 13.5	-	15	11			11			-	
Input Current I _{IN} Max.	-	0.18	18	±0.1	±0.1	±1	±1	-	±10 ⁻⁵	±0.1	μA

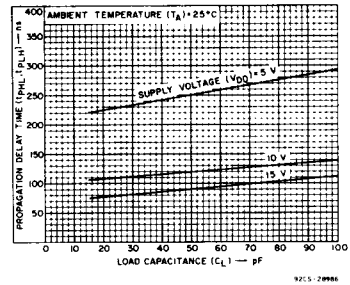

Fig. 12 - Typical propagation delay time as a function of load capacitance.

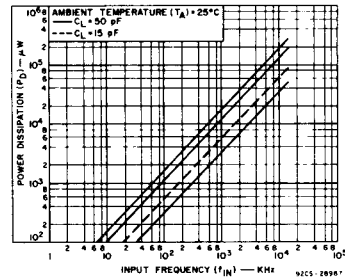
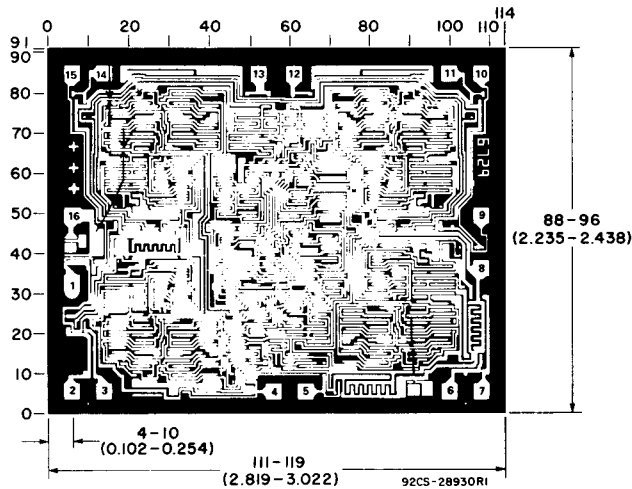

Fig. 13 - Dynamic power dissipation.



Dimensions and pad layout for the CD40192BH (dimensions and pad layout for the CD40193BH are identical).

Dimensions in parentheses are in millimeters and are derived from the basic inch dimensions as indicated. Grid graduations are in mils (10⁻³ inch).

3
COMMERCIAL CMOS
HIGH VOLTAGE ICs

CD40192B, CD40193B Types

DYNAMIC ELECTRICAL CHARACTERISTICS at $T_A = 25^\circ\text{C}$

Input $t_r, t_f = 20 \text{ ns}$, $C_L = 50 \text{ pF}$, $R_L = 200 \text{ k}\Omega$

CHARACTERISTIC	V_{DD} (V)	LIMITS			UNITS
		Min.	Typ.	Max.	
Propagation Delay Time t_{PHL}, t_{PLH} : CLOCK UP or CLOCK DOWN to Q, RESET to Q	5	—	250	500	ns
	10	—	120	240	
	15	—	90	180	
\overline{PE} to Q	5	—	200	400	ns
	10	—	100	200	
	15	—	70	140	
CLOCK UP to \overline{CARRY} , CLOCK DOWN to \overline{BORROW}	5	—	160	320	ns
	10	—	80	160	
	15	—	60	120	
\overline{RESET} or \overline{PE} to \overline{BORROW} or \overline{CARRY}	5	—	300	600	ns
	10	—	150	300	
	15	—	110	220	
Transition Time, t_{THL}, t_{TLH}	5	—	100	200	ns
	10	—	50	100	
	15	—	40	80	
Min. Removal Time, t_{rem} * RESET or \overline{PE}	5	—	40	80	ns
	10	—	20	40	
	15	—	15	30	
Min. Pulse Width, t_w RESET	5	—	240	480	ns
	10	—	150	300	
	15	—	130	260	
\overline{PE}	5	—	120	240	ns
	10	—	85	170	
	15	—	70	140	
CLOCK	5	—	90	180	ns
	10	—	45	90	
	15	—	30	60	
Max. Clock Input Frequency, f_{CL}	5	2	4	—	MHz
	10	4	8	—	
	15	5.5	11	—	
Clock Rise & Fall Time, t_r, t_f	5	—	—	15	μs
	10	—	—	15	
	15	—	—	5	
Input Capacitance, C_{IN} :					
	RESET	—	—	10	15
All Other Inputs	—	—	5	7.5	pF

* The time required for RESET or PRESET ENABLE control to be removed before clocking (see timing diagram, Fig. 10).

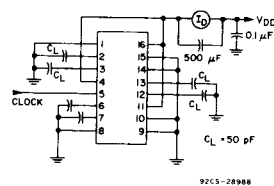

Fig. 14 – Dynamic power dissipation test circuit.

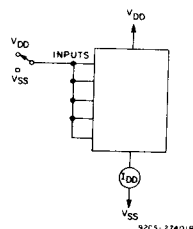

Fig. 15 – Quiescent device current test circuit.

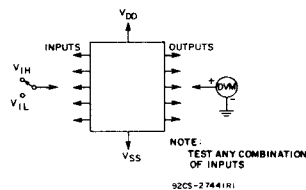

Fig. 16 – Input voltage test circuit.

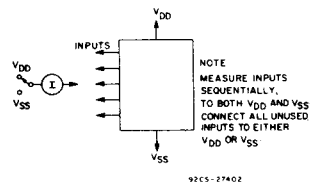

Fig. 17 – Input current test circuit.

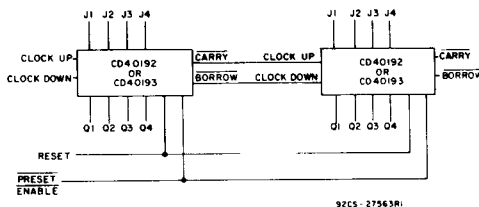

Fig. 18 – Cascaded counter packages.