

MATERIALS AND FINISHES:

BODY, HOUSING: BRASS
PLATED GOLD

CENTER CONTACT: BRASS
PLATED GOLD

INSULATOR: TEFLON

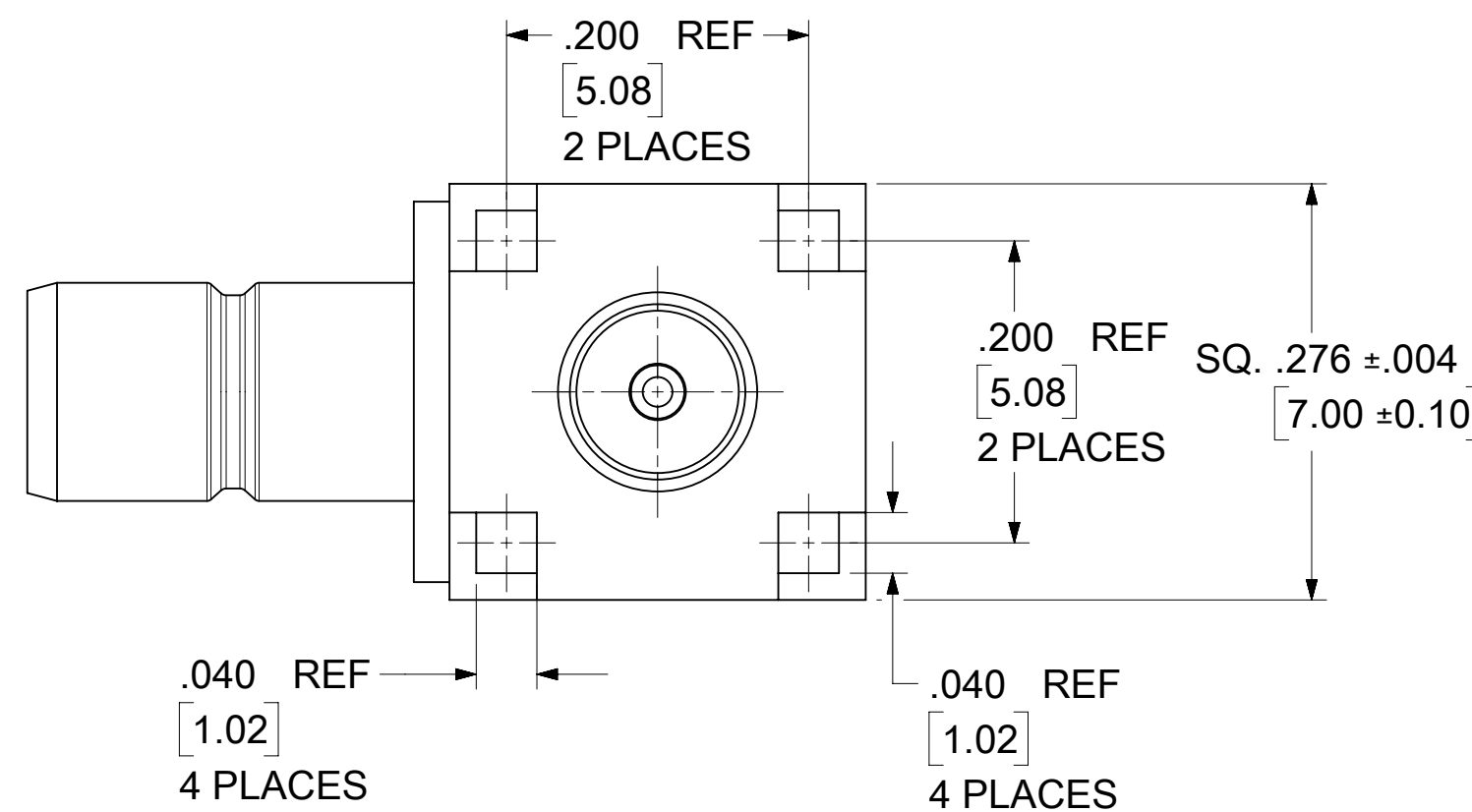
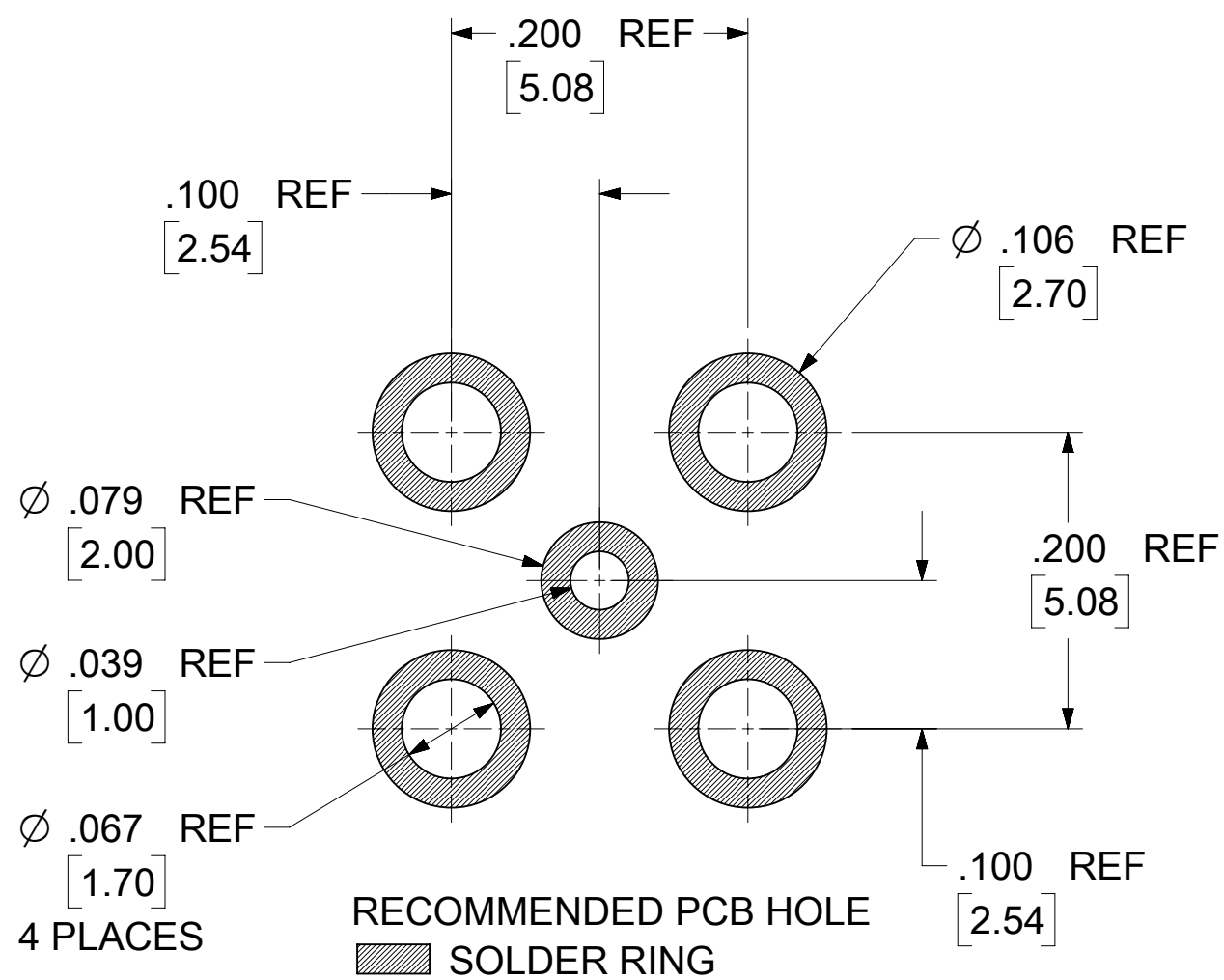
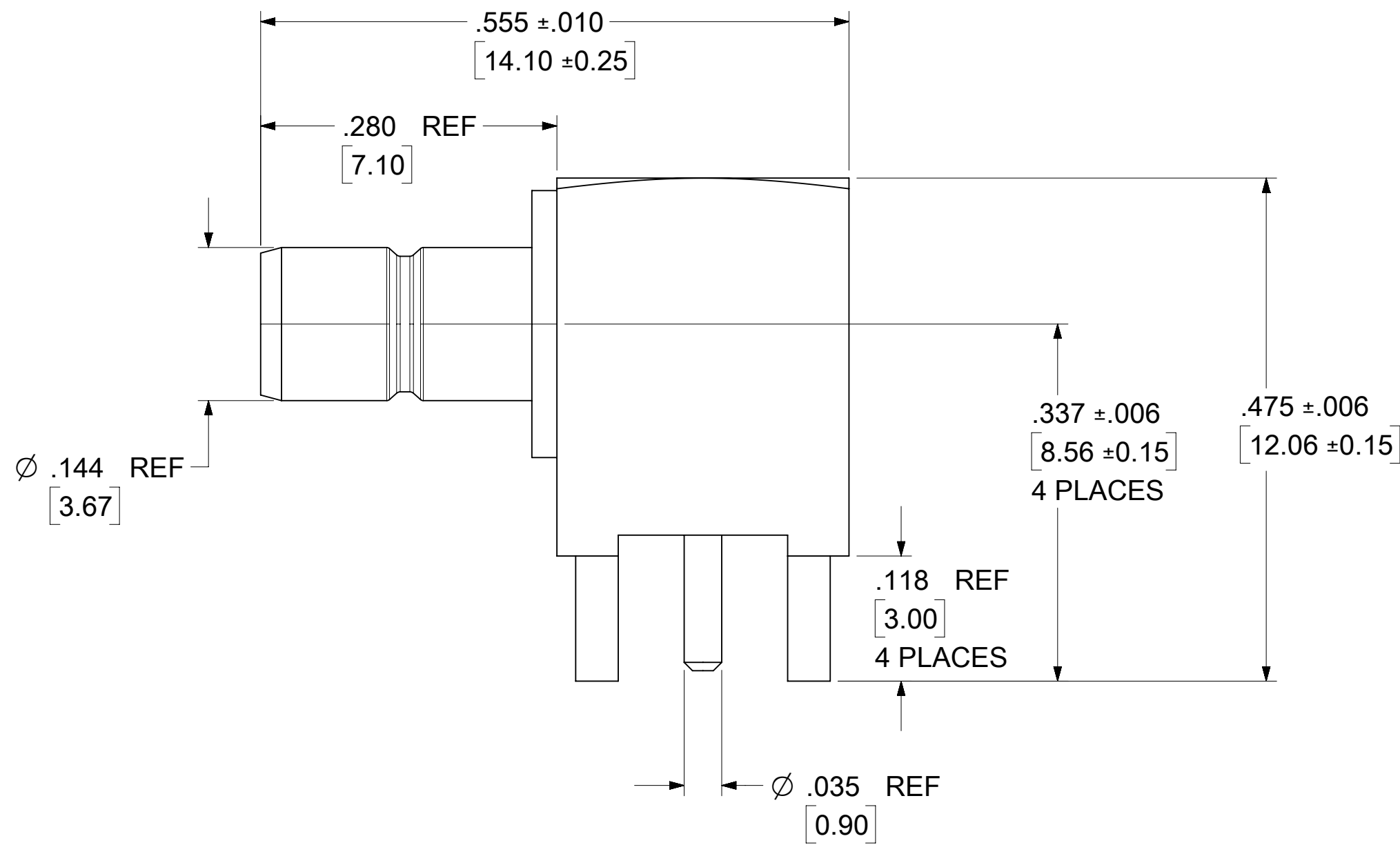
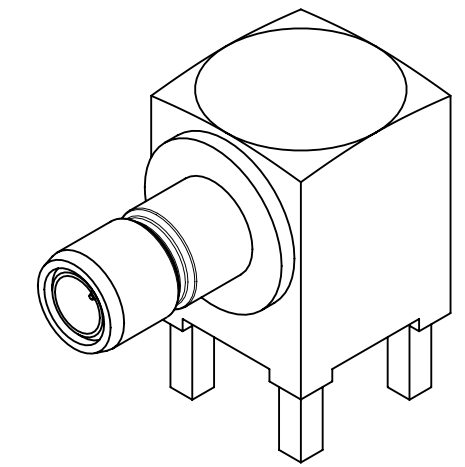



73396-0580	SMALL TRAY (20 PCS PER TRAY)	895420200
73404-2280	73100-0103, ONE PER BAG	895420089
73100-0103	TRAY (80 PCS PER TRAY)	895420040
PART NO.	PACKAGING	PACKING SPEC

RF LEAKAGE AND VSWR ARE NOT APPLICABLE IN PS-73598-0099

PS-73598-0099	PRODUCT SPECIFICATION
SPECIFICATION	DESCRIPTION

FUNCTIONAL SYMBOLS	THIS DRAWING CONTAINS INFORMATION THAT IS PROPRIETARY TO MOLEX ELECTRONIC TECHNOLOGIES, LLC AND SHOULD NOT BE USED WITHOUT WRITTEN PERMISSION			
	DIMENSION UNITS	SCALE		
FA = 0	IN/MM	NTS	CURRENT REV DESC: ADD PACKING SPEC PER EWR15423-A	
FC = 0	GENERAL TOLERANCES (UNLESS SPECIFIED)		EC NO: 720546	
FD = 0	ANGULAR TOL ± 2.0°		DRWN: CWEI02	2022/09/07
DIVISIONAL SYMBOLS	4 PLACES ±		CHK'D: YCHENG	2022/09/08
	3 PLACES ±		APPR: YCHENG	2022/09/08
	2 PLACES ±	0.25	INITIAL REVISION:	
	1 PLACE ±		DRWN: RFC_PLMIMP	2017/10/31
0 PLACES ±		APPR: JWIENER	2007/05/01	2022/09/08
DRAFT WHERE APPLICABLE MUST REMAIN WITHIN DIMENSIONS		THIRD ANGLE PROJECTION	DRAWING	SERIES
			C-SIZE	73100
DOCUMENT STATUS		P1	RELEASE DATE	2022/09/08 07:11:07
DOCUMENT NUMBER		CUSTOMER		SHEET NUMBER
SD-73100-0103		GENERAL MARKET		1 OF 1

DETAIL DRAWING REFER TO 73100-0103

CHG: ADD SMALL TRAY FOR 73100-0103 EC NO: URF2007-0306 DRWNSCHOU 2007/02/08 CHKD: 2007/02/09 APPR:MHUANG 2007/02/09 A	QUALITY SYMBOLS  = 0  = 0	GENERAL TOLERANCES (UNLESS SPECIFIED)		DIMENSION STYLE	SCALE	DESIGN UNITS	 THIRD ANGLE PROJECTION
		mm	INCH	MM/IN	METRIC		
		4 PLACES ± --- ± ---	± --- ± ---	DRAWN BY	DATE	TITLE	
		3 PLACES ± --- ± ---	± --- ± ---	JOYCE	2007/01/31	SMB JACK, R/A RECEPTACLE, PCB	
		2 PLACES ± --- ± ---	± --- ± ---	CHECKED BY	DATE	50 OHMS, SMB-J/PCB	
		1 PLACE ± --- ± ---	± --- ± ---	KERRIE	2007/01/31	MOLEX INCORPORATED	
		ANGULAR ± 2 °		APPROVED BY	DATE	MOLEX	
		DRAFT WHERE APPLICABLE MUST REMAIN WITHIN DIMENSIONS		MISEN	2007/01/31	DOCUMENT NO.	SHEET NO.
				MATERIAL NO.	733960580	SD-73396-058	1 OF 1
				SIZE	THIS DRAWING CONTAINS INFORMATION THAT IS PROPRIETARY TO MOLEX INCORPORATED AND SHOULD NOT BE USED WITHOUT WRITTEN PERMISSION		