

Surface Mount 1902.00MHz SAW Filter

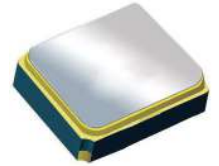

1.4 x 1.1 x 0.7 mm

AFS14A35-1902.00-T3

Moisture Sensitivity Level (MSL) – This product is Hermetically Sealed and not Moisture Sensitive - MSL = N/A: Not Applicable



**RoHS
Compliant**

FEATURES:

- 1.4 x 1.1 x 0.7 mm low profile SMT package
- Low Insertion loss
- Excellent selectivity with high out-of-band rejection

APPLICATIONS:

- Wireless Communication
- Remote Control
- Cellular Phones

ELECTRICAL SPECIFICATIONS:

Maximum Ratings

Item	Value
Input Power Level	+10 dBm max.
DC Permissive Voltage	3.0V DC max.
Operating Temperature Range	-20°C to + 75°C
Storage Temperature Range	-30°C to + 85°C

Parameters	Minimum	Typical	Maximum	Units	Notes
Center Frequency (f_c)		1902.00		MHz	
Insertion Loss (IL)		1.8	2.4	dB	(1884.55~1919.45MHz)
Effective Bandwidth		35		MHz	
Amplitude Ripple		0.5	1.0	dB	(1884.55~1919.45MHz)
Worst-Case Input / Output Return Loss		9.54	7.35	dB	(1884.55~1919.45MHz)
Output amplitude balance ($ S_{31}/S_{21} $)	-3	+1.9	+3.0	dB	(1884.55~1919.45 MHz)
Output Phase Balance ($\Phi(S_{31})-\Phi(S_{21})+180^\circ$)	-12	+6	+12	°	(1884.55~1919.45 MHz)
Stop-band Attenuation (Referenced to 0.0 dB)	35	40		dB	1349~1455 MHz
	35	46			1614~1687 MHz
	34	36			1731~1801 MHz
	18	22			1986~2056 MHz
	25	33			2037~2039 MHz
	35	42			2113~2186 MHz
	40	48			2386~2451 MHz
	40	51			3000~3840 MHz
	35	48			4941~5760 MHz
Terminating Source Impedance (Z_s)		50		Ω	
Terminating Load Impedance (Z_L) (Differential)		200 Ω // 22nH			

TEST CIRCUIT:

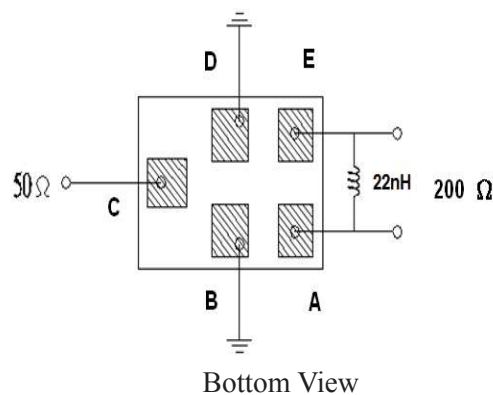

Surface Mount 1902.00MHz SAW Filter

AFS14A35-1902.00-T3



RoHS
Compliant

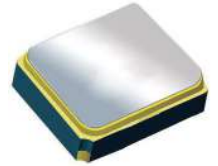

1.4 x 1.1 x 0.7 mm

OUTLINE DIMENSIONS:

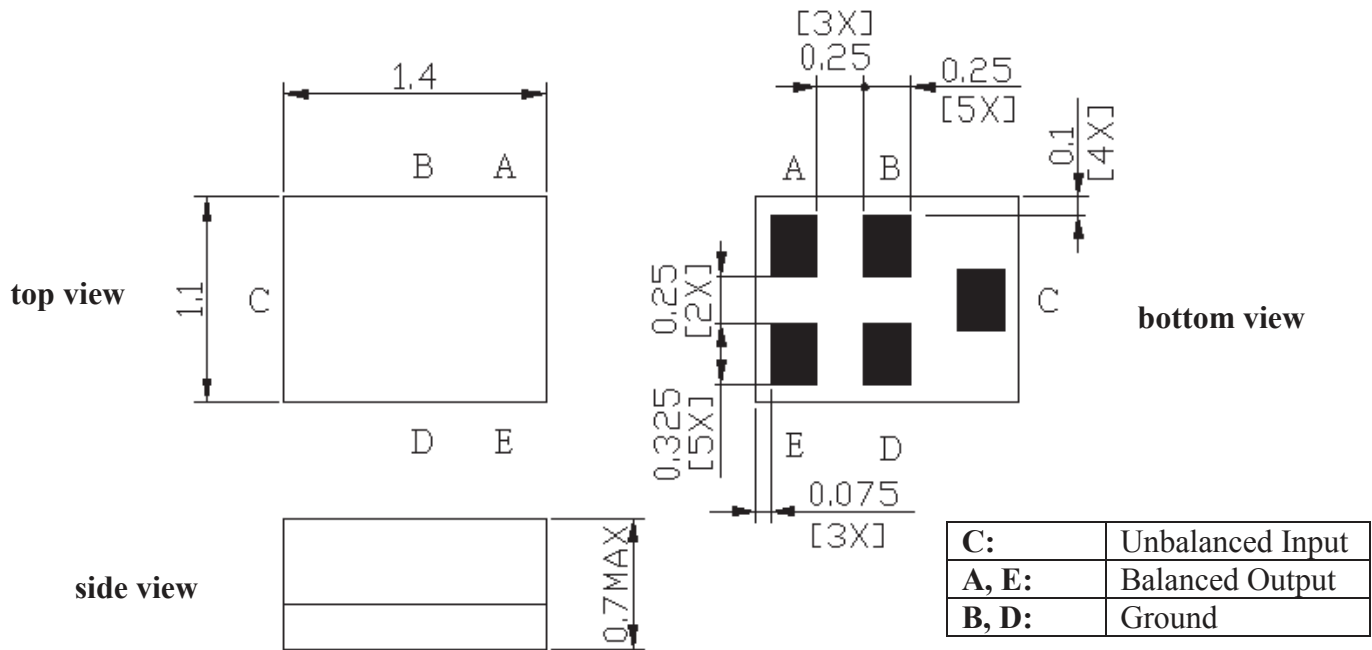

Recommended Land Pattern:

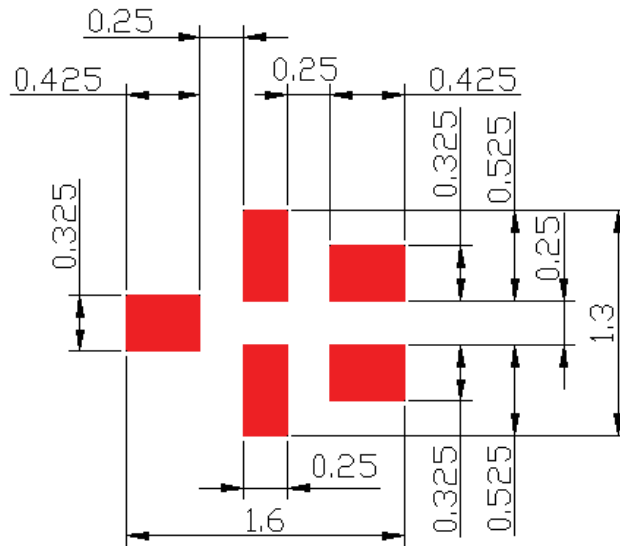

Surface Mount 1902.00MHz SAW Filter

AFS14A35-1902.00-T3



RoHS
Compliant

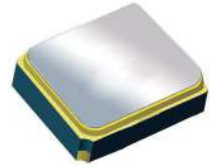

1.4 x 1.1 x 0.7 mm

FREQUENCY CHARACTERISTICS:

Filter Frequency Response (Narrowband)

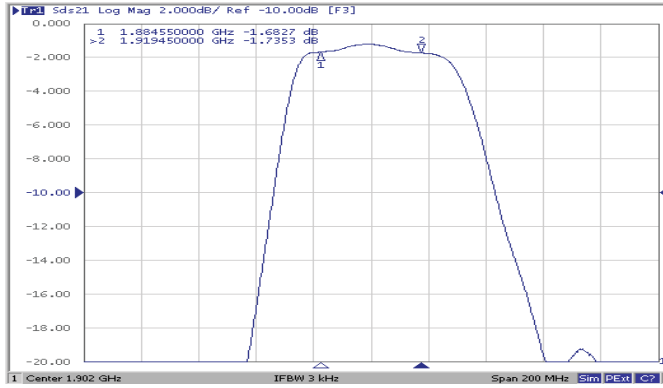

Filter Frequency Response (Wideband)

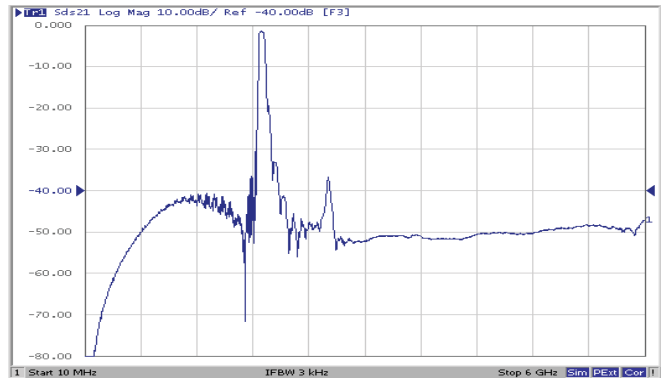
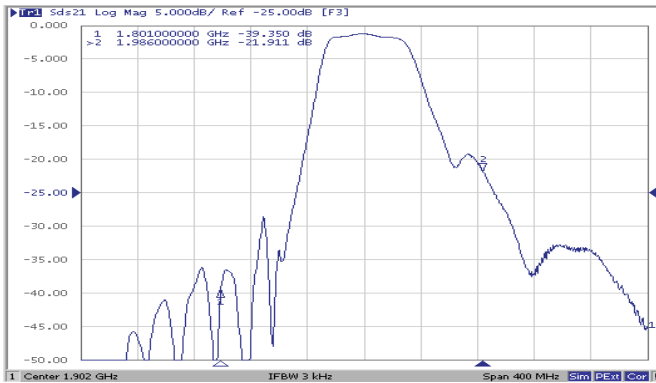

REFLECTION FUNCTIONS:

S11

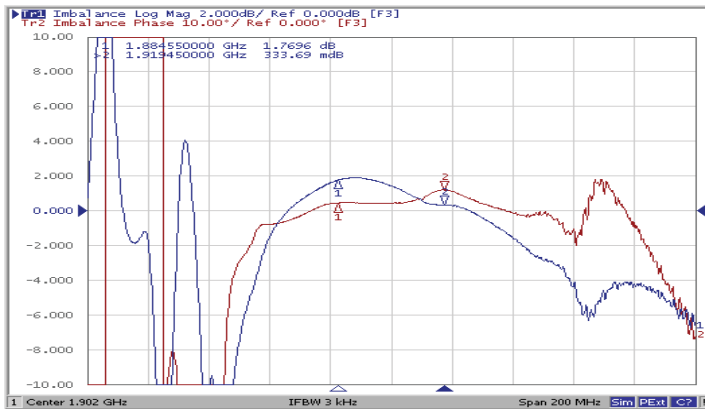

S22

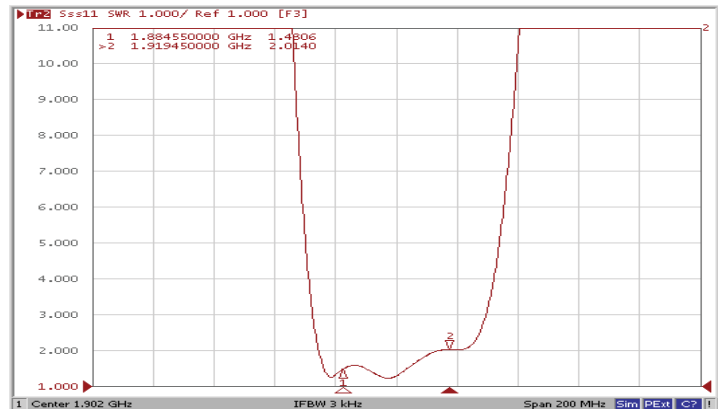

Surface Mount 1902.00MHz SAW Filter

AFS14A35-1902.00-T3



RoHS
Compliant

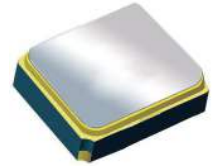

1.4 x 1.1 x 0.7 mm

REFLOW PROFILE:

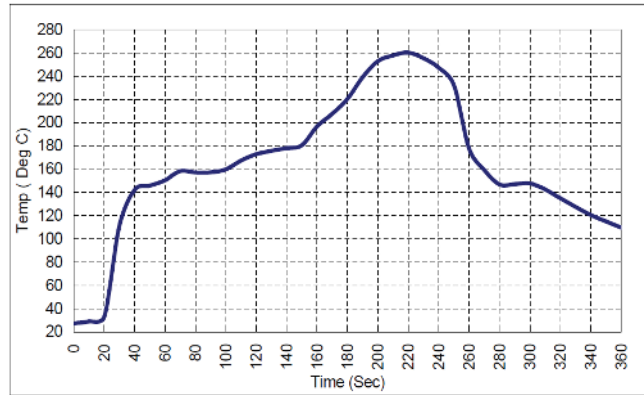

PACKAGING: 3000 Units/Reel “-T2” parts (2k/reel) are no longer available effective 01/01/2013

Reel Count : 7" = 3k units

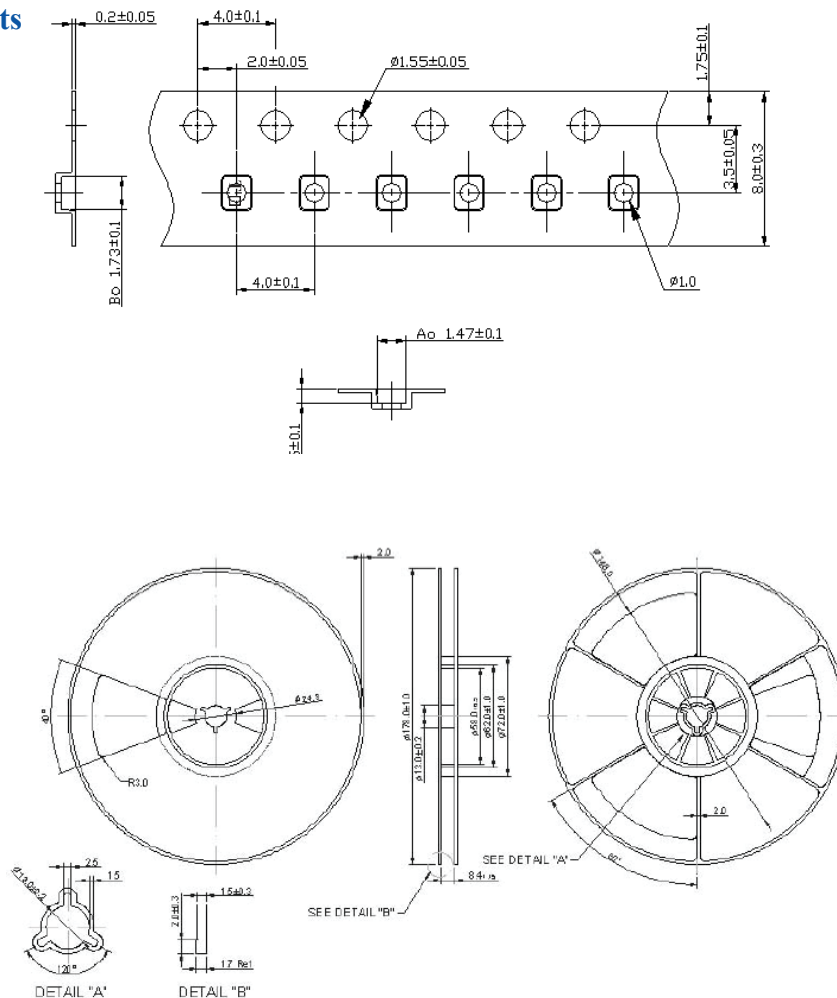

Dimensions: mm

ATTENTION: Abracon Corporation's products are COTS – Commercial-Off-The-Shelf products; suitable for Commercial, Industrial and, where designated, Automotive Applications. Abracon's products are not specifically designed for Military, Aviation, Aerospace, Life-dependant Medical applications or any application requiring high reliability where component failure could result in loss of life and/or property. For applications requiring high reliability and/or presenting an extreme operating environment, written consent and authorization from Abracon Corporation is required. Please contact Abracon Corporation for more information.

ABRACON IS
ISO 9001:2008
CERTIFIED



Visit www.abracon.com for Terms & Conditions of Sale
30332 Esperanza, Rancho Santa Margarita, California 92688
tel 949-546-8000 | fax 949-546-8001 | www.abracon.com

Revised: 04.16.13