



# Plastic Film Capacitors

## Metallized Polypropylene Film Capacitor

### EZPV series

#### Features

- High Safety (with safety function)
- Long product life, High reliability
- Low loss, Low ESR
- Flame retardant (Case and sealing resin)
- AEC-Q200 compliant (For automotive part No.)
- RoHS compliant

#### Recommended applications

- For DC filtering, DC link circuit
- Solar inverters
- Wind power generation
- Industrial power supplies
- Inverter circuit in appliances (Air Conditioners etc.)
- On board charger, AC/DC, DC/DC converter for automotive

#### Construction

- Dielectric : Polypropylene film
- Electrodes : Metallized dielectric with segmented pattern
- Plastic case : UL94 V-0
- Sealing : UL94 V-0
- Terminals : Tinned wires, 2-pin and 4-pin versions

#### Explanation of part number

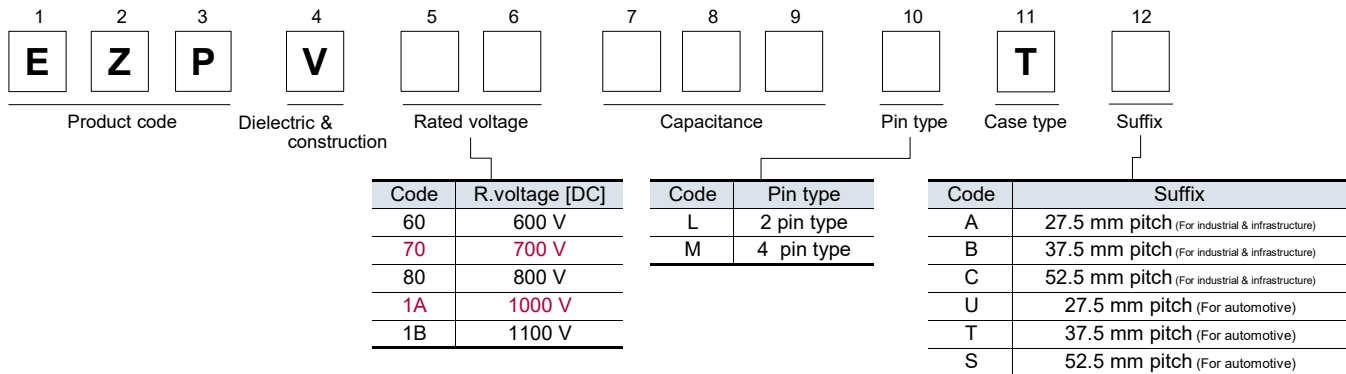

#### Specifications

|                              |   |                 |
|------------------------------|---|-----------------|
| Category temperature range*1 | -40 °C to +105 °C   |                 |
| Rated voltage*2 [DC]         | 600 V, 700 V, 800 V, 1000 V, 1100 V<br>(Derating of rated voltage by 1.0 %/°C at more than 85 °C) |                 |
| Rated capacitance            | 600 V   | 10 µF to 110 µF |
|                              | 700 V / 800 V   | 8 µF to 65 µF   |
|                              | 1000 V / 1100 V   | 3 µF to 40 µF   |
| Capacitance tolerance        | ±10 %   |                 |
| Withstand voltage            | Between terminals : Rated voltage (V) × 150 % 10 s  |                 |
|                              | Terminal to case : 2000 V [AC] 10 s   |                 |
| Insulation resistance (IR)   | CR ≥ 3,000 Ω·F (20 °C, 500 V, 60 s)   |                 |

\*1 : The temperature of capacitor surface (case).

\*2 : Use for DC voltage only.

Dimensions

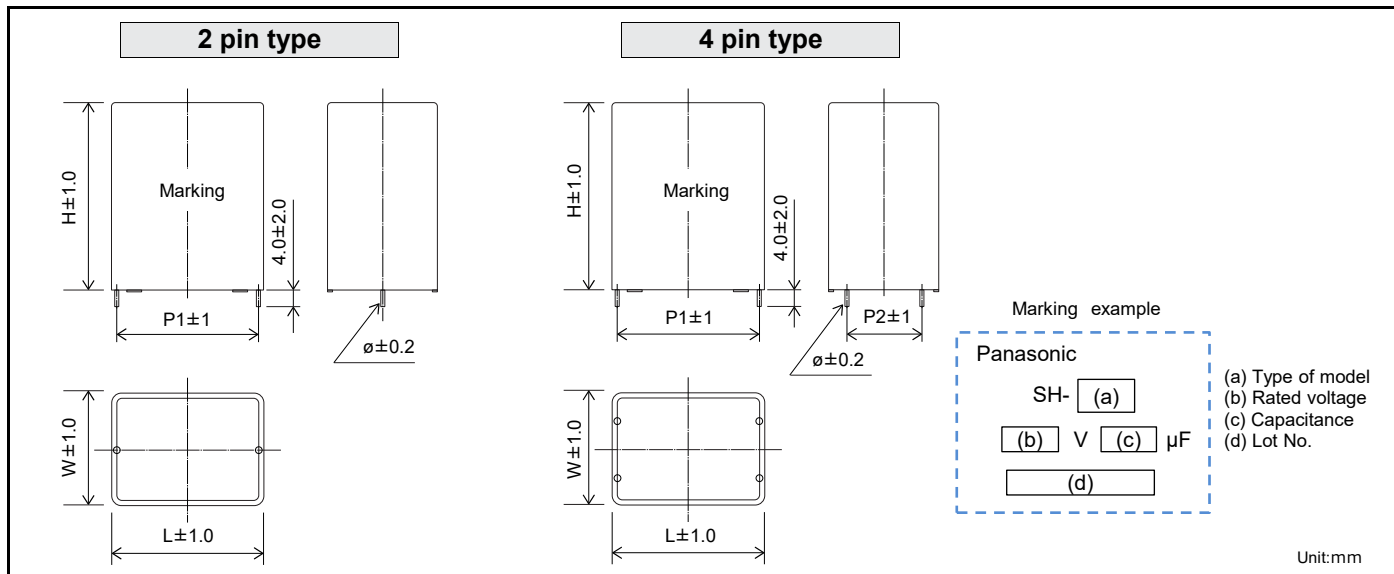

Rating · Dimensions · Quantity

For industrial & infrastructure

■ Rated voltage [DC] : 600 V

| Part No.     | Cap. Tol. (%) | Cap. (μF) | Dimensions (mm) |      |      |      |      |     | dv/dt (V/μs) | Permissible current                            |   | ESR <sup>*3</sup> (mΩ) | Mass (g) | Min. order Qty <sup>*4</sup> (PCS) |
|--------------|---------------|-----------|-----------------|------|------|------|------|-----|--------------|--|---|------------------------|----------|------------------------------------|
|              |               |           | W               | H    | L    | P1   | P2   | ø   |              | Peak current <sup>*1</sup> (A <sub>0-P</sub> ) | RMS current <sup>*2</sup> (A <sub>rms</sub> ) |                        |          |                                    |
| EZPV60106LTB | ±10           | 10        | 15.0            | 29.0 | 41.0 | 37.5 | -    | 1.0 | 25           | 250  | 8.6   | 16.9                   | 22       | 1200                               |
| EZPV60126LTB | ±10           | 12        | 15.0            | 29.0 | 41.0 | 37.5 | -    | 1.0 | 25           | 300  | 9.2   | 14.3                   | 23       | 1200                               |
| EZPV60156LTB | ±10           | 15        | 17.0            | 34.5 | 41.0 | 37.5 | -    | 1.0 | 25           | 375  | 10.0  | 12.8                   | 28       | 1200                               |
| EZPV60206MTB | ±10           | 20        | 22.0            | 36.0 | 41.0 | 37.5 | 10.2 | 1.0 | 25           | 500  | 11.9  | 10.4                   | 39       | 600                                |
| EZPV60226MTB | ±10           | 22        | 22.0            | 36.0 | 41.0 | 37.5 | 10.2 | 1.0 | 25           | 550  | 12.7  | 9.6                    | 41       | 600                                |
| EZPV60256MTB | ±10           | 25        | 22.0            | 36.0 | 41.0 | 37.5 | 10.2 | 1.0 | 25           | 625  | 13.8  | 8.6                    | 42       | 600                                |
| EZPV60306MTB | ±10           | 30        | 26.0            | 40.5 | 41.0 | 37.5 | 10.2 | 1.0 | 25           | 750  | 15.6  | 8.2                    | 54       | 600                                |
| EZPV60356MTB | ±10           | 35        | 26.0            | 40.5 | 41.0 | 37.5 | 10.2 | 1.0 | 25           | 875  | 17.2  | 7.1                    | 55       | 600                                |
| EZPV60406MTB | ±10           | 40        | 27.5            | 42.0 | 41.5 | 37.5 | 10.2 | 1.0 | 25           | 1000   | 18.7  | 6.5                    | 59       | 600                                |
| EZPV60456MTB | ±10           | 45        | 30.0            | 50.5 | 41.0 | 37.5 | 20.3 | 1.0 | 25           | 1125   | 20.1  | 6.2                    | 71       | 400                                |
| EZPV60506MTB | ±10           | 50        | 30.0            | 50.5 | 41.0 | 37.5 | 20.3 | 1.0 | 25           | 1250   | 21.5  | 5.3                    | 74       | 400                                |
| EZPV60556MTB | ±10           | 55        | 30.0            | 50.5 | 41.0 | 37.5 | 20.3 | 1.0 | 25           | 1375   | 22.0  | 4.5                    | 81       | 400                                |
| EZPV60606MTB | ±10           | 60        | 30.0            | 56.0 | 41.5 | 37.5 | 20.3 | 1.2 | 25           | 1500   | 22.5  | 4.1                    | 85       | 400                                |
| EZPV60656MTB | ±10           | 65        | 30.0            | 56.0 | 41.5 | 37.5 | 20.3 | 1.2 | 25           | 1625   | 23.0  | 3.6                    | 88       | 400                                |
| EZPV60706MTB | ±10           | 70        | 38.0            | 52.5 | 42.0 | 37.5 | 20.3 | 1.2 | 25           | 1750   | 23.4  | 3.6                    | 108      | 400                                |
| EZPV60756MTB | ±10           | 75        | 38.0            | 57.0 | 42.0 | 37.5 | 20.3 | 1.2 | 25           | 1875   | 23.8  | 4.1                    | 109      | 400                                |
| EZPV60806MTB | ±10           | 80        | 43.0            | 58.0 | 41.0 | 37.5 | 20.3 | 1.2 | 25           | 2000   | 24.3  | 3.9                    | 129      | 400                                |
| EZPV60856MTB | ±10           | 85        | 43.0            | 58.0 | 41.0 | 37.5 | 20.3 | 1.2 | 25           | 2125   | 24.7  | 3.7                    | 132      | 400                                |
| EZPV60406MTC | ±10           | 40        | 25.0            | 40.0 | 57.0 | 52.5 | 10.2 | 1.2 | 15           | 600  | 16.9  | 8.4                    | 67       | 600                                |
| EZPV60456MTC | ±10           | 45        | 25.0            | 40.0 | 57.0 | 52.5 | 10.2 | 1.2 | 15           | 675  | 18.0  | 7.6                    | 68       | 600                                |
| EZPV60506MTC | ±10           | 50        | 25.0            | 40.0 | 57.0 | 52.5 | 10.2 | 1.2 | 15           | 750  | 19.1  | 6.8                    | 70       | 600                                |
| EZPV60556MTC | ±10           | 55        | 30.0            | 51.0 | 57.5 | 52.5 | 10.2 | 1.2 | 15           | 825  | 20.1  | 8.0                    | 92       | 200                                |
| EZPV60606MTC | ±10           | 60        | 30.0            | 51.0 | 57.5 | 52.5 | 10.2 | 1.2 | 15           | 900  | 21.0  | 7.5                    | 94       | 200                                |
| EZPV60656MTC | ±10           | 65        | 30.0            | 51.0 | 57.5 | 52.5 | 20.3 | 1.2 | 15           | 975  | 21.9  | 7.0                    | 95       | 200                                |
| EZPV60706MTC | ±10           | 70        | 30.0            | 51.0 | 57.5 | 52.5 | 20.3 | 1.2 | 15           | 1050   | 22.8  | 6.6                    | 97       | 200                                |
| EZPV60756MTC | ±10           | 75        | 30.0            | 51.0 | 57.5 | 52.5 | 20.3 | 1.2 | 15           | 1125   | 23.6  | 5.5                    | 101      | 200                                |
| EZPV60806MTC | ±10           | 80        | 30.0            | 51.0 | 57.5 | 52.5 | 20.3 | 1.2 | 15           | 1200   | 24.5  | 4.9                    | 108      | 200                                |
| EZPV60856MTC | ±10           | 85        | 30.0            | 51.0 | 57.5 | 52.5 | 20.3 | 1.2 | 15           | 1275   | 25.3  | 4.6                    | 110      | 200                                |
| EZPV60906MTC | ±10           | 90        | 35.0            | 50.0 | 57.5 | 52.5 | 20.3 | 1.2 | 15           | 1350   | 26.0  | 4.7                    | 121      | 200                                |
| EZPV60956MTC | ±10           | 95        | 35.0            | 50.0 | 57.5 | 52.5 | 20.3 | 1.2 | 15           | 1425   | 26.8  | 5.2                    | 122      | 200                                |
| EZPV60107MTC | ±10           | 100       | 40.0            | 51.5 | 57.0 | 52.5 | 20.3 | 1.2 | 15           | 1500   | 27.5  | 5.1                    | 145      | 200                                |
| EZPV60117MTC | ±10           | 110       | 35.0            | 56.0 | 57.5 | 52.5 | 20.3 | 1.2 | 15           | 1650   | 28.9  | 4.8                    | 138      | 200                                |

\*1 : When rising temperature of capacitor surface by continuous peak current(included pulse current), use within limit specified for temperature of capacitor surface and self heating temperature rise.

\*2 : Maximum RMS current @ 70°C , 10kHz Use within limit for self heating temperature rise at capacitor surface.

\*3 : 20 °C、10 kHz

\*4 : Minimum order quantity consists of 4 packing units.

## Rating · Dimensions · Quantity

## For industrial &amp; infrastructure

■ Rated voltage [DC] : 700 V

**NEW**

| Part No.     | Cap. Tol. (%) | Cap. (μF) | Dimensions (mm) |      |      |      |      |     | dv/dt (V/μs) | Permissible current                            |                                   | ESR <sup>*3</sup> (mΩ) | Mass (g) | Min. order Qty <sup>*4</sup> (PCS) |
|--------------|---------------|-----------|-----------------|------|------|------|------|-----|--------------|--|-----------------------------------|------------------------|----------|------------------------------------|
|              |               |           | W               | H    | L    | P1   | P2   | ∅   |              | Peak current <sup>*1</sup> (A <sub>0-P</sub> ) | RMS current <sup>*2</sup> (A rms) |                        |          |                                    |
| EZPV70905LTA | ±10           | 9         | 20.5            | 41.5 | 31.0 | 27.5 | -    | 0.8 | 35           | 315  | 12.3                              | 12.6                   | 30       | 800                                |
| EZPV70905MTA | ±10           | 9         | 20.5            | 41.5 | 31.0 | 27.5 | 10.2 | 0.8 | 35           | 315  | 12.3                              | 12.6                   | 30       | 800                                |
| EZPV70106LTA | ±10           | 10        | 20.5            | 41.5 | 31.0 | 27.5 | -    | 0.8 | 35           | 350  | 12.9                              | 11.5                   | 31       | 800                                |
| EZPV70106MTA | ±10           | 10        | 20.5            | 41.5 | 31.0 | 27.5 | 10.2 | 0.8 | 35           | 350  | 12.9                              | 11.5                   | 31       | 800                                |
| EZPV70116LTA | ±10           | 11        | 20.5            | 41.5 | 31.0 | 27.5 | -    | 0.8 | 35           | 385  | 13.6                              | 10.6                   | 32       | 800                                |
| EZPV70116MTA | ±10           | 11        | 20.5            | 41.5 | 31.0 | 27.5 | 10.2 | 0.8 | 35           | 385  | 13.6                              | 10.6                   | 32       | 800                                |
| EZPV70126LTA | ±10           | 12        | 20.5            | 41.5 | 31.0 | 27.5 | -    | 0.8 | 35           | 420  | 14.2                              | 9.9                    | 33       | 800                                |
| EZPV70126MTA | ±10           | 12        | 20.5            | 41.5 | 31.0 | 27.5 | 10.2 | 0.8 | 35           | 420  | 14.2                              | 9.9                    | 33       | 800                                |
| EZPV70136LTA | ±10           | 13        | 26.0            | 41.0 | 31.0 | 27.5 | -    | 1.0 | 35           | 455  | 14.7                              | 9.2                    | 42       | 600                                |
| EZPV70136MTA | ±10           | 13        | 26.0            | 41.0 | 31.0 | 27.5 | 10.2 | 1.0 | 35           | 455  | 14.7                              | 9.2                    | 42       | 600                                |
| EZPV70146LTA | ±10           | 14        | 26.0            | 41.0 | 31.0 | 27.5 | -    | 1.0 | 35           | 490  | 15.3                              | 8.7                    | 42       | 600                                |
| EZPV70146MTA | ±10           | 14        | 26.0            | 41.0 | 31.0 | 27.5 | 10.2 | 1.0 | 35           | 490  | 15.3                              | 8.7                    | 42       | 600                                |
| EZPV70186LTA | ±10           | 18        | 22.0            | 53.5 | 31.0 | 27.5 | -    | 1.2 | 35           | 630  | 17.3                              | 7.8                    | 54       | 600                                |
| EZPV70186MTA | ±10           | 18        | 22.0            | 53.5 | 31.0 | 27.5 | 10.2 | 1.2 | 35           | 630  | 17.3                              | 7.8                    | 54       | 600                                |
| EZPV70805LTB | ±10           | 8         | 17.0            | 34.5 | 41.0 | 37.5 | -    | 1.0 | 35           | 280  | 8.2                               | 17.1                   | 28       | 1200                               |
| EZPV70905LTB | ±10           | 9         | 17.0            | 34.5 | 41.0 | 37.5 | -    | 1.0 | 35           | 315  | 8.9                               | 15.6                   | 28       | 1200                               |
| EZPV70106LTB | ±10           | 10        | 17.0            | 34.5 | 41.0 | 37.5 | -    | 1.0 | 35           | 350  | 9.5                               | 13.9                   | 30       | 1200                               |
| EZPV70126LTB | ±10           | 12        | 22.0            | 36.0 | 41.0 | 37.5 | -    | 1.0 | 35           | 420  | 10.7                              | 12.5                   | 39       | 600                                |
| EZPV70156MTB | ±10           | 15        | 22.0            | 36.0 | 41.0 | 37.5 | 10.2 | 1.0 | 35           | 525  | 13.0                              | 10.2                   | 42       | 600                                |
| EZPV70206MTB | ±10           | 20        | 26.0            | 40.5 | 41.0 | 37.5 | 10.2 | 1.0 | 35           | 700  | 15.8                              | 8.7                    | 55       | 600                                |
| EZPV70256MTB | ±10           | 25        | 30.0            | 50.5 | 41.0 | 37.5 | 10.2 | 1.0 | 35           | 875  | 18.3                              | 8.7                    | 70       | 400                                |
| EZPV70306MTB | ±10           | 30        | 30.0            | 50.5 | 41.0 | 37.5 | 20.3 | 1.0 | 35           | 1050   | 20.6                              | 7.1                    | 74       | 400                                |
| EZPV70356MTB | ±10           | 35        | 30.0            | 56.0 | 41.5 | 37.5 | 20.3 | 1.2 | 35           | 1225   | 22.7                              | 5.5                    | 86       | 400                                |
| EZPV70406MTB | ±10           | 40        | 38.0            | 52.5 | 42.0 | 37.5 | 20.3 | 1.2 | 35           | 1400   | 24.6                              | 5.1                    | 108      | 400                                |
| EZPV70456MTB | ±10           | 45        | 38.0            | 57.0 | 42.0 | 37.5 | 20.3 | 1.2 | 35           | 1575   | 26.4                              | 4.5                    | 117      | 400                                |
| EZPV70506MTB | ±10           | 50        | 43.0            | 58.0 | 41.0 | 37.5 | 20.3 | 1.2 | 35           | 1750   | 28.2                              | 4.8                    | 132      | 400                                |
| EZPV70256MTC | ±10           | 25        | 25.0            | 40.0 | 57.0 | 52.5 | 10.2 | 1.2 | 22           | 550  | 14.4                              | 11.6                   | 68       | 600                                |
| EZPV70306MTC | ±10           | 30        | 30.0            | 51.0 | 57.5 | 52.5 | 10.2 | 1.2 | 22           | 660  | 16.8                              | 11.6                   | 91       | 200                                |
| EZPV70356MTC | ±10           | 35        | 30.0            | 51.0 | 57.5 | 52.5 | 10.2 | 1.2 | 22           | 770  | 18.9                              | 10.2                   | 94       | 200                                |
| EZPV70406MTC | ±10           | 40        | 30.0            | 51.0 | 57.5 | 52.5 | 20.3 | 1.2 | 22           | 880  | 20.9                              | 9.1                    | 97       | 200                                |
| EZPV70456MTC | ±10           | 45        | 30.0            | 51.0 | 57.5 | 52.5 | 20.3 | 1.2 | 22           | 990  | 22.8                              | 7.9                    | 101      | 200                                |
| EZPV70506MTC | ±10           | 50        | 30.0            | 51.0 | 57.5 | 52.5 | 20.3 | 1.2 | 22           | 1100   | 24.5                              | 6.8                    | 110      | 200                                |
| EZPV70556MTC | ±10           | 55        | 35.0            | 50.0 | 57.5 | 52.5 | 20.3 | 1.2 | 22           | 1210   | 26.2                              | 6.3                    | 122      | 200                                |
| EZPV70606MTC | ±10           | 60        | 35.0            | 56.0 | 57.5 | 52.5 | 20.3 | 1.2 | 22           | 1320   | 27.8                              | 6.2                    | 137      | 200                                |
| EZPV70656MTC | ±10           | 65        | 35.0            | 64.5 | 57.5 | 52.5 | 20.3 | 1.2 | 22           | 1430   | 29.3                              | 6.2                    | 140      | 200                                |

\*1 : When rising temperature of capacitor surface by continuous peak current(included pulse current), use within limit specified for temperature of capacitor surface and self heating temperature rise.

\*2 : Maximum RMS current @ 70°C , 10kHz Use within limit for self heating temperature rise at capacitor surface.

\*3 : 20 °C、10 kHz

\*4 : Minimum order quantity consists of 4 packing units.

## Rating · Dimensions · Quantity

## For industrial &amp; infrastructure

■ Rated voltage [DC] : 800 V

| Part No.                | Cap. Tol. (%) | Cap. (μF) | Dimensions (mm) |      |      |      |      |     | dv/dt (V/μs) | Permissible current                            |                                   | ESR <sup>*3</sup> (mΩ) | Mass (g) | Min. order Qty <sup>*4</sup> (PCS) |
|-------------------------|---------------|-----------|-----------------|------|------|------|------|-----|--------------|--|-----------------------------------|------------------------|----------|------------------------------------|
|                         |               |           | W               | H    | L    | P1   | P2   | ∅   |              | Peak current <sup>*1</sup> (A <sub>0-p</sub> ) | RMS current <sup>*2</sup> (A rms) |                        |          |                                    |
| EZPV80905LTA            | ±10           | 9         | 20.5            | 41.5 | 31.0 | 27.5 | -    | 0.8 | 35           | 315  | 12.3                              | 12.6                   | 30       | 800                                |
| <b>NEW</b> EZPV80905MTA | ±10           | 9         | 20.5            | 41.5 | 31.0 | 27.5 | 10.2 | 0.8 | 35           | 315  | 12.3                              | 12.6                   | 30       | 800                                |
| EZPV80106LTA            | ±10           | 10        | 20.5            | 41.5 | 31.0 | 27.5 | -    | 0.8 | 35           | 350  | 12.9                              | 11.5                   | 31       | 800                                |
| <b>NEW</b> EZPV80106MTA | ±10           | 10        | 20.5            | 41.5 | 31.0 | 27.5 | 10.2 | 0.8 | 35           | 350  | 12.9                              | 11.5                   | 31       | 800                                |
| EZPV80116LTA            | ±10           | 11        | 20.5            | 41.5 | 31.0 | 27.5 | -    | 0.8 | 35           | 385  | 13.6                              | 10.6                   | 32       | 800                                |
| <b>NEW</b> EZPV80116MTA | ±10           | 11        | 20.5            | 41.5 | 31.0 | 27.5 | 10.2 | 0.8 | 35           | 385  | 13.6                              | 10.6                   | 32       | 800                                |
| EZPV80126LTA            | ±10           | 12        | 20.5            | 41.5 | 31.0 | 27.5 | -    | 0.8 | 35           | 420  | 14.2                              | 9.9                    | 33       | 800                                |
| <b>NEW</b> EZPV80126MTA | ±10           | 12        | 20.5            | 41.5 | 31.0 | 27.5 | 10.2 | 0.8 | 35           | 420  | 14.2                              | 9.9                    | 33       | 800                                |
| EZPV80136LTA            | ±10           | 13        | 26.0            | 41.0 | 31.0 | 27.5 | -    | 1.0 | 35           | 455  | 14.7                              | 9.2                    | 42       | 600                                |
| <b>NEW</b> EZPV80136MTA | ±10           | 13        | 26.0            | 41.0 | 31.0 | 27.5 | 10.2 | 1.0 | 35           | 455  | 14.7                              | 9.2                    | 42       | 600                                |
| EZPV80146LTA            | ±10           | 14        | 26.0            | 41.0 | 31.0 | 27.5 | -    | 1.0 | 35           | 490  | 15.3                              | 8.7                    | 42       | 600                                |
| <b>NEW</b> EZPV80146MTA | ±10           | 14        | 26.0            | 41.0 | 31.0 | 27.5 | 10.2 | 1.0 | 35           | 490  | 15.3                              | 8.7                    | 42       | 600                                |
| EZPV80186LTA            | ±10           | 18        | 22.0            | 53.5 | 31.0 | 27.5 | -    | 1.2 | 35           | 630  | 17.3                              | 7.8                    | 54       | 600                                |
| <b>NEW</b> EZPV80186MTA | ±10           | 18        | 22.0            | 53.5 | 31.0 | 27.5 | 10.2 | 1.2 | 35           | 630  | 17.3                              | 7.8                    | 54       | 600                                |
| EZPV80805LTB            | ±10           | 8         | 17.0            | 34.5 | 41.0 | 37.5 | -    | 1.0 | 35           | 280  | 8.2                               | 17.1                   | 28       | 1200                               |
| EZPV80905LTB            | ±10           | 9         | 17.0            | 34.5 | 41.0 | 37.5 | -    | 1.0 | 35           | 315  | 8.9                               | 15.6                   | 28       | 1200                               |
| EZPV80106LTB            | ±10           | 10        | 17.0            | 34.5 | 41.0 | 37.5 | -    | 1.0 | 35           | 350  | 9.5                               | 13.9                   | 30       | 1200                               |
| EZPV80126LTB            | ±10           | 12        | 22.0            | 36.0 | 41.0 | 37.5 | -    | 1.0 | 35           | 420  | 10.7                              | 12.5                   | 39       | 600                                |
| EZPV80156MTB            | ±10           | 15        | 22.0            | 36.0 | 41.0 | 37.5 | 10.2 | 1.0 | 35           | 525  | 13.0                              | 10.2                   | 42       | 600                                |
| EZPV80206MTB            | ±10           | 20        | 26.0            | 40.5 | 41.0 | 37.5 | 10.2 | 1.0 | 35           | 700  | 15.8                              | 8.7                    | 55       | 600                                |
| EZPV80256MTB            | ±10           | 25        | 30.0            | 50.5 | 41.0 | 37.5 | 10.2 | 1.0 | 35           | 875  | 18.3                              | 8.7                    | 70       | 400                                |
| EZPV80306MTB            | ±10           | 30        | 30.0            | 50.5 | 41.0 | 37.5 | 20.3 | 1.0 | 35           | 1050   | 20.6                              | 7.1                    | 74       | 400                                |
| EZPV80356MTB            | ±10           | 35        | 30.0            | 56.0 | 41.5 | 37.5 | 20.3 | 1.2 | 35           | 1225   | 22.7                              | 5.5                    | 86       | 400                                |
| EZPV80406MTB            | ±10           | 40        | 38.0            | 52.5 | 42.0 | 37.5 | 20.3 | 1.2 | 35           | 1400   | 24.6                              | 5.1                    | 108      | 400                                |
| EZPV80456MTB            | ±10           | 45        | 38.0            | 57.0 | 42.0 | 37.5 | 20.3 | 1.2 | 35           | 1575   | 26.4                              | 4.5                    | 117      | 400                                |
| EZPV80506MTB            | ±10           | 50        | 43.0            | 58.0 | 41.0 | 37.5 | 20.3 | 1.2 | 35           | 1750   | 28.2                              | 4.8                    | 132      | 400                                |
| EZPV80256MTC            | ±10           | 25        | 25.0            | 40.0 | 57.0 | 52.5 | 10.2 | 1.2 | 22           | 550  | 14.4                              | 11.6                   | 68       | 600                                |
| EZPV80306MTC            | ±10           | 30        | 30.0            | 51.0 | 57.5 | 52.5 | 10.2 | 1.2 | 22           | 660  | 16.8                              | 11.6                   | 91       | 200                                |
| EZPV80356MTC            | ±10           | 35        | 30.0            | 51.0 | 57.5 | 52.5 | 10.2 | 1.2 | 22           | 770  | 18.9                              | 10.2                   | 94       | 200                                |
| EZPV80406MTC            | ±10           | 40        | 30.0            | 51.0 | 57.5 | 52.5 | 20.3 | 1.2 | 22           | 880  | 20.9                              | 9.1                    | 97       | 200                                |
| EZPV80456MTC            | ±10           | 45        | 30.0            | 51.0 | 57.5 | 52.5 | 20.3 | 1.2 | 22           | 990  | 22.8                              | 7.9                    | 101      | 200                                |
| EZPV80506MTC            | ±10           | 50        | 30.0            | 51.0 | 57.5 | 52.5 | 20.3 | 1.2 | 22           | 1100   | 24.5                              | 6.8                    | 110      | 200                                |
| EZPV80556MTC            | ±10           | 55        | 35.0            | 50.0 | 57.5 | 52.5 | 20.3 | 1.2 | 22           | 1210   | 26.2                              | 6.3                    | 122      | 200                                |
| EZPV80606MTC            | ±10           | 60        | 35.0            | 56.0 | 57.5 | 52.5 | 20.3 | 1.2 | 22           | 1320   | 27.8                              | 6.2                    | 137      | 200                                |
| EZPV80656MTC            | ±10           | 65        | 35.0            | 64.5 | 57.5 | 52.5 | 20.3 | 1.2 | 22           | 1430   | 29.3                              | 6.2                    | 140      | 200                                |

\*1 : When rising temperature of capacitor surface by continuous peak current(included pulse current), use within limit specified for temperature of capacitor surface and self heating temperature rise.

\*2 : Maximum RMS current @ 70°C , 10kHz Use within limit for self heating temperature rise at capacitor surface.

\*3 : 20 °C、10 kHz

\*4 : Minimum order quantity consists of 4 packing units.

## Rating · Dimensions · Quantity

## For industrial &amp; infrastructure

■ Rated voltage [DC] : 1000 V

**NEW**

| Part No.     | Cap. Tol. (%) | Cap. (μF) | Dimensions (mm) |      |      |      |      |     | dv/dt (V/μs) | Permissible current                            |                                   | ESR <sup>*3</sup> (mΩ) | Mass (g) | Min. order Qty <sup>*4</sup> (PCS) |
|--------------|---------------|-----------|-----------------|------|------|------|------|-----|--------------|--|-----------------------------------|------------------------|----------|------------------------------------|
|              |               |           | W               | H    | L    | P1   | P2   | ∅   |              | Peak current <sup>*1</sup> (A <sub>0-P</sub> ) | RMS current <sup>*2</sup> (A rms) |                        |          |                                    |
| EZPV1A305LTB | ±10           | 3         | 15.0            | 29.0 | 41.0 | 37.5 | -    | 1.0 | 50           | 150  | 4.4                               | 30.8                   | 22       | 1200                               |
| EZPV1A405LTB | ±10           | 4         | 15.0            | 29.0 | 41.0 | 37.5 | -    | 1.0 | 50           | 200  | 5.5                               | 23.5                   | 23       | 1200                               |
| EZPV1A475LTB | ±10           | 4.7       | 17.0            | 34.5 | 41.0 | 37.5 | -    | 1.0 | 50           | 235  | 6.2                               | 21.7                   | 28       | 1200                               |
| EZPV1A505LTB | ±10           | 5         | 17.0            | 34.5 | 41.0 | 37.5 | -    | 1.0 | 50           | 250  | 6.5                               | 20.4                   | 28       | 1200                               |
| EZPV1A605LTB | ±10           | 6         | 17.0            | 34.5 | 41.0 | 37.5 | -    | 1.0 | 50           | 300  | 7.3                               | 17.5                   | 29       | 1200                               |
| EZPV1A705MTB | ±10           | 7         | 22.0            | 36.0 | 41.0 | 37.5 | 10.2 | 1.0 | 50           | 350  | 8.5                               | 15.5                   | 39       | 600                                |
| EZPV1A805MTB | ±10           | 8         | 22.0            | 36.0 | 41.0 | 37.5 | 10.2 | 1.0 | 50           | 400  | 9.5                               | 13.7                   | 41       | 600                                |
| EZPV1A905MTB | ±10           | 9         | 22.0            | 36.0 | 41.0 | 37.5 | 10.2 | 1.0 | 50           | 450  | 10.4                              | 12.4                   | 42       | 600                                |
| EZPV1A106MTB | ±10           | 10        | 23.5            | 43.5 | 41.5 | 37.5 | 10.2 | 1.0 | 50           | 500  | 11.2                              | 12.7                   | 48       | 400                                |
| EZPV1A126MTB | ±10           | 12        | 26.0            | 40.5 | 41.0 | 37.5 | 10.2 | 1.0 | 50           | 600  | 12.8                              | 10.4                   | 55       | 600                                |
| EZPV1A156MTB | ±10           | 15        | 30.0            | 50.5 | 41.0 | 37.5 | 10.2 | 1.0 | 50           | 750  | 15.0                              | 10.4                   | 70       | 400                                |
| EZPV1A186MTB | ±10           | 18        | 30.0            | 50.5 | 41.0 | 37.5 | 20.3 | 1.0 | 50           | 900  | 16.9                              | 8.5                    | 74       | 400                                |
| EZPV1A206MTB | ±10           | 20        | 30.0            | 56.0 | 41.5 | 37.5 | 20.3 | 1.2 | 50           | 1000   | 18.1                              | 7.2                    | 82       | 400                                |
| EZPV1A256MTB | ±10           | 25        | 38.0            | 52.5 | 42.0 | 37.5 | 20.3 | 1.2 | 50           | 1250   | 20.9                              | 5.9                    | 108      | 400                                |
| EZPV1A306MTB | ±10           | 30        | 43.0            | 58.0 | 41.0 | 37.5 | 20.3 | 1.2 | 50           | 1500   | 23.4                              | 5.7                    | 132      | 400                                |
| EZPV1A156MTC | ±10           | 15        | 25.0            | 40.0 | 57.0 | 52.5 | 10.2 | 1.2 | 30           | 450  | 10.6                              | 13.7                   | 67       | 600                                |
| EZPV1A206MTC | ±10           | 20        | 35.5            | 45.5 | 57.5 | 52.5 | 10.2 | 1.2 | 30           | 600  | 12.2                              | 11.2                   | 106      | 200                                |
| EZPV1A256MTC | ±10           | 25        | 35.5            | 45.5 | 57.5 | 52.5 | 20.3 | 1.2 | 30           | 750  | 13.6                              | 9.1                    | 111      | 200                                |
| EZPV1A306MTC | ±10           | 30        | 35.0            | 50.0 | 57.5 | 52.5 | 20.3 | 1.2 | 30           | 900  | 14.9                              | 9.9                    | 116      | 200                                |
| EZPV1A356MTC | ±10           | 35        | 35.0            | 56.0 | 57.5 | 52.5 | 20.3 | 1.2 | 30           | 1050   | 16.1                              | 9.2                    | 132      | 200                                |
| EZPV1A406MTC | ±10           | 40        | 35.0            | 56.0 | 57.5 | 52.5 | 20.3 | 1.2 | 30           | 1200   | 17.2                              | 7.8                    | 138      | 200                                |

\*1 : When rising temperature of capacitor surface by continuous peak current(included pulse current), use within limit specified for temperature of capacitor surface and self heating temperature rise.

\*2 : Maximum RMS current @ 70°C , 10kHz Use within limit for self heating temperature rise at capacitor surface.

\*3 : 20 °C、10 kHz

\*4 : Minimum order quantity consists of 4 packing units.

## Rating · Dimensions · Quantity

## For industrial &amp; infrastructure

■ Rated voltage [DC] : 1100 V

| Part No.     | Cap. Tol. (%) | Cap. (μF) | Dimensions (mm) |      |      |      |      |     | dv/dt (V/μs) | Permissible current                            |                                   | ESR <sup>*3</sup> (mΩ) | Mass (g) | Min. order Qty <sup>*4</sup> (PCS) |
|--------------|---------------|-----------|-----------------|------|------|------|------|-----|--------------|--|-----------------------------------|------------------------|----------|------------------------------------|
|              |               |           | W               | H    | L    | P1   | P2   | ∅   |              | Peak current <sup>*1</sup> (A <sub>0-P</sub> ) | RMS current <sup>*2</sup> (A rms) |                        |          |                                    |
| EZPV1B305LTB | ±10           | 3         | 15.0            | 29.0 | 41.0 | 37.5 | -    | 1.0 | 50           | 150  | 4.4                               | 30.8                   | 22       | 1200                               |
| EZPV1B405LTB | ±10           | 4         | 15.0            | 29.0 | 41.0 | 37.5 | -    | 1.0 | 50           | 200  | 5.5                               | 23.5                   | 23       | 1200                               |
| EZPV1B475LTB | ±10           | 4.7       | 17.0            | 34.5 | 41.0 | 37.5 | -    | 1.0 | 50           | 235  | 6.2                               | 21.7                   | 28       | 1200                               |
| EZPV1B505LTB | ±10           | 5         | 17.0            | 34.5 | 41.0 | 37.5 | -    | 1.0 | 50           | 250  | 6.5                               | 20.4                   | 28       | 1200                               |
| EZPV1B605LTB | ±10           | 6         | 17.0            | 34.5 | 41.0 | 37.5 | -    | 1.0 | 50           | 300  | 7.3                               | 17.5                   | 29       | 1200                               |
| EZPV1B705MTB | ±10           | 7         | 22.0            | 36.0 | 41.0 | 37.5 | 10.2 | 1.0 | 50           | 350  | 8.5                               | 15.5                   | 39       | 600                                |
| EZPV1B805MTB | ±10           | 8         | 22.0            | 36.0 | 41.0 | 37.5 | 10.2 | 1.0 | 50           | 400  | 9.5                               | 13.7                   | 41       | 600                                |
| EZPV1B905MTB | ±10           | 9         | 22.0            | 36.0 | 41.0 | 37.5 | 10.2 | 1.0 | 50           | 450  | 10.4                              | 12.4                   | 42       | 600                                |
| EZPV1B106MTB | ±10           | 10        | 23.5            | 43.5 | 41.5 | 37.5 | 10.2 | 1.0 | 50           | 500  | 11.2                              | 12.7                   | 48       | 400                                |
| EZPV1B126MTB | ±10           | 12        | 26.0            | 40.5 | 41.0 | 37.5 | 10.2 | 1.0 | 50           | 600  | 12.8                              | 10.4                   | 55       | 600                                |
| EZPV1B156MTB | ±10           | 15        | 30.0            | 50.5 | 41.0 | 37.5 | 10.2 | 1.0 | 50           | 750  | 15.0                              | 10.4                   | 70       | 400                                |
| EZPV1B186MTB | ±10           | 18        | 30.0            | 50.5 | 41.0 | 37.5 | 20.3 | 1.0 | 50           | 900  | 16.9                              | 8.5                    | 74       | 400                                |
| EZPV1B206MTB | ±10           | 20        | 30.0            | 56.0 | 41.5 | 37.5 | 20.3 | 1.2 | 50           | 1000   | 18.1                              | 7.2                    | 82       | 400                                |
| EZPV1B256MTB | ±10           | 25        | 38.0            | 52.5 | 42.0 | 37.5 | 20.3 | 1.2 | 50           | 1250   | 20.9                              | 5.9                    | 108      | 400                                |
| EZPV1B306MTB | ±10           | 30        | 43.0            | 58.0 | 41.0 | 37.5 | 20.3 | 1.2 | 50           | 1500   | 23.4                              | 5.7                    | 132      | 400                                |
| EZPV1B156MTC | ±10           | 15        | 25.0            | 40.0 | 57.0 | 52.5 | 10.2 | 1.2 | 30           | 450  | 10.6                              | 13.7                   | 67       | 600                                |
| EZPV1B206MTC | ±10           | 20        | 35.5            | 45.5 | 57.5 | 52.5 | 10.2 | 1.2 | 30           | 600  | 12.2                              | 11.2                   | 106      | 200                                |
| EZPV1B256MTC | ±10           | 25        | 35.5            | 45.5 | 57.5 | 52.5 | 20.3 | 1.2 | 30           | 750  | 13.6                              | 9.1                    | 111      | 200                                |
| EZPV1B306MTC | ±10           | 30        | 35.0            | 50.0 | 57.5 | 52.5 | 20.3 | 1.2 | 30           | 900  | 14.9                              | 9.9                    | 116      | 200                                |
| EZPV1B356MTC | ±10           | 35        | 35.0            | 56.0 | 57.5 | 52.5 | 20.3 | 1.2 | 30           | 1050   | 16.1                              | 9.2                    | 132      | 200                                |
| EZPV1B406MTC | ±10           | 40        | 35.0            | 56.0 | 57.5 | 52.5 | 20.3 | 1.2 | 30           | 1200   | 17.2                              | 7.8                    | 138      | 200                                |

\*1 : When rising temperature of capacitor surface by continuous peak current(included pulse current), use within limit specified for temperature of capacitor surface and self heating temperature rise.

\*2 : Maximum RMS current @ 70°C , 10kHz Use within limit for self heating temperature rise at capacitor surface.

\*3 : 20 °C、10 kHz

\*4 : Minimum order quantity consists of 4 packing units.

## Rating · Dimensions · Quantity

## For automotive

■ Rated voltage [DC] : 600 V

| Part No.     | Cap. Tol. (%) | Cap. (μF) | Dimensions (mm) |      |      |      |      |     | dv/dt (V/μs) | Permissible current                            |                                   | ESR <sup>*3</sup> (mΩ) | Mass (g) | Min. order Qty <sup>*4</sup> (PCS) |
|--------------|---------------|-----------|-----------------|------|------|------|------|-----|--------------|--|-----------------------------------|------------------------|----------|------------------------------------|
|              |               |           | W               | H    | L    | P1   | P2   | ∅   |              | Peak current <sup>*1</sup> (A <sub>0-P</sub> ) | RMS current <sup>*2</sup> (A rms) |                        |          |                                    |
| EZPV60106LTT | ±10           | 10        | 15.0            | 29.0 | 41.0 | 37.5 | -    | 1.0 | 25           | 250  | 8.6                               | 16.9                   | 22       | 1200                               |
| EZPV60126LTT | ±10           | 12        | 15.0            | 29.0 | 41.0 | 37.5 | -    | 1.0 | 25           | 300  | 9.2                               | 14.3                   | 23       | 1200                               |
| EZPV60156LTT | ±10           | 15        | 17.0            | 34.5 | 41.0 | 37.5 | -    | 1.0 | 25           | 375  | 10.0                              | 12.8                   | 28       | 1200                               |
| EZPV60206MTT | ±10           | 20        | 22.0            | 36.0 | 41.0 | 37.5 | 10.2 | 1.0 | 25           | 500  | 11.9                              | 10.4                   | 39       | 600                                |
| EZPV60226MTT | ±10           | 22        | 22.0            | 36.0 | 41.0 | 37.5 | 10.2 | 1.0 | 25           | 550  | 12.7                              | 9.6                    | 41       | 600                                |
| EZPV60256MTT | ±10           | 25        | 22.0            | 36.0 | 41.0 | 37.5 | 10.2 | 1.0 | 25           | 625  | 13.8                              | 8.6                    | 42       | 600                                |
| EZPV60306MTT | ±10           | 30        | 26.0            | 40.5 | 41.0 | 37.5 | 10.2 | 1.0 | 25           | 750  | 15.6                              | 8.2                    | 54       | 600                                |
| EZPV60356MTT | ±10           | 35        | 26.0            | 40.5 | 41.0 | 37.5 | 10.2 | 1.0 | 25           | 875  | 17.2                              | 7.1                    | 55       | 600                                |
| EZPV60406MTT | ±10           | 40        | 27.5            | 42.0 | 41.5 | 37.5 | 10.2 | 1.0 | 25           | 1000   | 18.7                              | 6.5                    | 59       | 600                                |
| EZPV60456MTT | ±10           | 45        | 30.0            | 50.5 | 41.0 | 37.5 | 20.3 | 1.0 | 25           | 1125   | 20.1                              | 6.2                    | 71       | 400                                |
| EZPV60506MTT | ±10           | 50        | 30.0            | 50.5 | 41.0 | 37.5 | 20.3 | 1.0 | 25           | 1250   | 21.5                              | 5.3                    | 74       | 400                                |
| EZPV60556MTT | ±10           | 55        | 30.0            | 50.5 | 41.0 | 37.5 | 20.3 | 1.0 | 25           | 1375   | 22.0                              | 4.5                    | 81       | 400                                |
| EZPV60606MTT | ±10           | 60        | 30.0            | 56.0 | 41.5 | 37.5 | 20.3 | 1.2 | 25           | 1500   | 22.5                              | 4.1                    | 85       | 400                                |
| EZPV60656MTT | ±10           | 65        | 30.0            | 56.0 | 41.5 | 37.5 | 20.3 | 1.2 | 25           | 1625   | 23.0                              | 3.6                    | 88       | 400                                |
| EZPV60706MTT | ±10           | 70        | 38.0            | 52.5 | 42.0 | 37.5 | 20.3 | 1.2 | 25           | 1750   | 23.4                              | 3.6                    | 108      | 400                                |
| EZPV60756MTT | ±10           | 75        | 38.0            | 57.0 | 42.0 | 37.5 | 20.3 | 1.2 | 25           | 1875   | 23.8                              | 4.1                    | 109      | 400                                |
| EZPV60806MTT | ±10           | 80        | 43.0            | 58.0 | 41.0 | 37.5 | 20.3 | 1.2 | 25           | 2000   | 24.3                              | 3.9                    | 129      | 400                                |
| EZPV60856MTT | ±10           | 85        | 43.0            | 58.0 | 41.0 | 37.5 | 20.3 | 1.2 | 25           | 2125   | 24.7                              | 3.7                    | 132      | 400                                |
| EZPV60406MTS | ±10           | 40        | 25.0            | 40.0 | 57.0 | 52.5 | 10.2 | 1.2 | 15           | 600  | 16.9                              | 8.4                    | 67       | 600                                |
| EZPV60456MTS | ±10           | 45        | 25.0            | 40.0 | 57.0 | 52.5 | 10.2 | 1.2 | 15           | 675  | 18.0                              | 7.6                    | 68       | 600                                |
| EZPV60506MTS | ±10           | 50        | 25.0            | 40.0 | 57.0 | 52.5 | 10.2 | 1.2 | 15           | 750  | 19.1                              | 6.8                    | 70       | 600                                |
| EZPV60556MTS | ±10           | 55        | 30.0            | 51.0 | 57.5 | 52.5 | 10.2 | 1.2 | 15           | 825  | 20.1                              | 8.0                    | 92       | 200                                |
| EZPV60606MTS | ±10           | 60        | 30.0            | 51.0 | 57.5 | 52.5 | 10.2 | 1.2 | 15           | 900  | 21.0                              | 7.5                    | 94       | 200                                |
| EZPV60656MTS | ±10           | 65        | 30.0            | 51.0 | 57.5 | 52.5 | 20.3 | 1.2 | 15           | 975  | 21.9                              | 7.0                    | 95       | 200                                |
| EZPV60706MTS | ±10           | 70        | 30.0            | 51.0 | 57.5 | 52.5 | 20.3 | 1.2 | 15           | 1050   | 22.8                              | 6.6                    | 97       | 200                                |
| EZPV60756MTS | ±10           | 75        | 30.0            | 51.0 | 57.5 | 52.5 | 20.3 | 1.2 | 15           | 1125   | 23.6                              | 5.5                    | 101      | 200                                |
| EZPV60806MTS | ±10           | 80        | 30.0            | 51.0 | 57.5 | 52.5 | 20.3 | 1.2 | 15           | 1200   | 24.5                              | 4.9                    | 108      | 200                                |
| EZPV60856MTS | ±10           | 85        | 30.0            | 51.0 | 57.5 | 52.5 | 20.3 | 1.2 | 15           | 1275   | 25.3                              | 4.6                    | 110      | 200                                |
| EZPV60906MTS | ±10           | 90        | 35.0            | 50.0 | 57.5 | 52.5 | 20.3 | 1.2 | 15           | 1350   | 26.0                              | 4.7                    | 121      | 200                                |
| EZPV60956MTS | ±10           | 95        | 35.0            | 50.0 | 57.5 | 52.5 | 20.3 | 1.2 | 15           | 1425   | 26.8                              | 5.2                    | 122      | 200                                |
| EZPV60107MTS | ±10           | 100       | 40.0            | 51.5 | 57.0 | 52.5 | 20.3 | 1.2 | 15           | 1500   | 27.5                              | 5.1                    | 145      | 200                                |
| EZPV60117MTS | ±10           | 110       | 35.0            | 56.0 | 57.5 | 52.5 | 20.3 | 1.2 | 15           | 1650   | 28.9                              | 4.8                    | 138      | 200                                |

\*1 : When rising temperature of capacitor surface by continuous peak current(included pulse current), use within limit specified for temperature of capacitor surface and self heating temperature rise.

\*2 : Maximum RMS current @ 70°C , 10kHz Use within limit for self heating temperature rise at capacitor surface.

\*3 : 20 °C、10 kHz

\*4 : Minimum order quantity consists of 4 packing units.

## Rating · Dimensions · Quantity

For automotive

■ Rated voltage [DC] : 700 V

**NEW**

| Part No.     | Cap. Tol. (%) | Cap. (μF) | Dimensions (mm) |      |      |      |      |     | dv/dt (V/μs) | Permissible current                            |                                   | ESR <sup>*3</sup> (mΩ) | Mass (g) | Min. order Qty <sup>*4</sup> (PCS) |
|--------------|---------------|-----------|-----------------|------|------|------|------|-----|--------------|--|-----------------------------------|------------------------|----------|------------------------------------|
|              |               |           | W               | H    | L    | P1   | P2   | ∅   |              | Peak current <sup>*1</sup> (A <sub>0-p</sub> ) | RMS current <sup>*2</sup> (A rms) |                        |          |                                    |
| EZPV70905LTU | ±10           | 9         | 20.5            | 41.5 | 31.0 | 27.5 | -    | 0.8 | 35           | 315  | 12.3                              | 12.6                   | 30       | 800                                |
| EZPV70905MTU | ±10           | 9         | 20.5            | 41.5 | 31.0 | 27.5 | 10.2 | 0.8 | 35           | 315  | 12.3                              | 12.6                   | 30       | 800                                |
| EZPV70106LTU | ±10           | 10        | 20.5            | 41.5 | 31.0 | 27.5 | -    | 0.8 | 35           | 350  | 12.9                              | 11.5                   | 31       | 800                                |
| EZPV70106MTU | ±10           | 10        | 20.5            | 41.5 | 31.0 | 27.5 | 10.2 | 0.8 | 35           | 350  | 12.9                              | 11.5                   | 31       | 800                                |
| EZPV70116LTU | ±10           | 11        | 20.5            | 41.5 | 31.0 | 27.5 | -    | 0.8 | 35           | 385  | 13.6                              | 10.6                   | 32       | 800                                |
| EZPV70116MTU | ±10           | 11        | 20.5            | 41.5 | 31.0 | 27.5 | 10.2 | 0.8 | 35           | 385  | 13.6                              | 10.6                   | 32       | 800                                |
| EZPV70126LTU | ±10           | 12        | 20.5            | 41.5 | 31.0 | 27.5 | -    | 0.8 | 35           | 420  | 14.2                              | 9.9                    | 33       | 800                                |
| EZPV70126MTU | ±10           | 12        | 20.5            | 41.5 | 31.0 | 27.5 | 10.2 | 0.8 | 35           | 420  | 14.2                              | 9.9                    | 33       | 800                                |
| EZPV70136LTU | ±10           | 13        | 26.0            | 41.0 | 31.0 | 27.5 | -    | 1.0 | 35           | 455  | 14.7                              | 9.2                    | 42       | 600                                |
| EZPV70136MTU | ±10           | 13        | 26.0            | 41.0 | 31.0 | 27.5 | 10.2 | 1.0 | 35           | 455  | 14.7                              | 9.2                    | 42       | 600                                |
| EZPV70146LTU | ±10           | 14        | 26.0            | 41.0 | 31.0 | 27.5 | -    | 1.0 | 35           | 490  | 15.3                              | 8.7                    | 42       | 600                                |
| EZPV70146MTU | ±10           | 14        | 26.0            | 41.0 | 31.0 | 27.5 | 10.2 | 1.0 | 35           | 490  | 15.3                              | 8.7                    | 42       | 600                                |
| EZPV70186LTU | ±10           | 18        | 22.0            | 53.5 | 31.0 | 27.5 | -    | 1.2 | 35           | 630  | 17.3                              | 7.8                    | 54       | 600                                |
| EZPV70186MTU | ±10           | 18        | 22.0            | 53.5 | 31.0 | 27.5 | 10.2 | 1.2 | 35           | 630  | 17.3                              | 7.8                    | 54       | 600                                |
| EZPV70805LTT | ±10           | 8         | 17.0            | 34.5 | 41.0 | 37.5 | -    | 1.0 | 35           | 280  | 8.2                               | 17.1                   | 28       | 1200                               |
| EZPV70905LTT | ±10           | 9         | 17.0            | 34.5 | 41.0 | 37.5 | -    | 1.0 | 35           | 315  | 8.9                               | 15.6                   | 28       | 1200                               |
| EZPV70106LTT | ±10           | 10        | 17.0            | 34.5 | 41.0 | 37.5 | -    | 1.0 | 35           | 350  | 9.5                               | 13.9                   | 30       | 1200                               |
| EZPV70126LTT | ±10           | 12        | 22.0            | 36.0 | 41.0 | 37.5 | -    | 1.0 | 35           | 420  | 10.7                              | 12.5                   | 39       | 600                                |
| EZPV70156MTT | ±10           | 15        | 22.0            | 36.0 | 41.0 | 37.5 | 10.2 | 1.0 | 35           | 525  | 13.0                              | 10.2                   | 42       | 600                                |
| EZPV70206MTT | ±10           | 20        | 26.0            | 40.5 | 41.0 | 37.5 | 10.2 | 1.0 | 35           | 700  | 15.8                              | 8.7                    | 55       | 600                                |
| EZPV70256MTT | ±10           | 25        | 30.0            | 50.5 | 41.0 | 37.5 | 10.2 | 1.0 | 35           | 875  | 18.3                              | 8.7                    | 70       | 400                                |
| EZPV70306MTT | ±10           | 30        | 30.0            | 50.5 | 41.0 | 37.5 | 20.3 | 1.0 | 35           | 1050   | 20.6                              | 7.1                    | 74       | 400                                |
| EZPV70356MTT | ±10           | 35        | 30.0            | 56.0 | 41.5 | 37.5 | 20.3 | 1.2 | 35           | 1225   | 22.7                              | 5.5                    | 86       | 400                                |
| EZPV70406MTT | ±10           | 40        | 38.0            | 52.5 | 42.0 | 37.5 | 20.3 | 1.2 | 35           | 1400   | 24.6                              | 5.1                    | 108      | 400                                |
| EZPV70456MTT | ±10           | 45        | 38.0            | 57.0 | 42.0 | 37.5 | 20.3 | 1.2 | 35           | 1575   | 26.4                              | 4.5                    | 117      | 400                                |
| EZPV70506MTT | ±10           | 50        | 43.0            | 58.0 | 41.0 | 37.5 | 20.3 | 1.2 | 35           | 1750   | 28.2                              | 4.8                    | 132      | 400                                |
| EZPV70256MTS | ±10           | 25        | 25.0            | 40.0 | 57.0 | 52.5 | 10.2 | 1.2 | 22           | 550  | 14.4                              | 11.6                   | 68       | 600                                |
| EZPV70306MTS | ±10           | 30        | 30.0            | 51.0 | 57.5 | 52.5 | 10.2 | 1.2 | 22           | 660  | 16.8                              | 11.6                   | 91       | 200                                |
| EZPV70356MTS | ±10           | 35        | 30.0            | 51.0 | 57.5 | 52.5 | 10.2 | 1.2 | 22           | 770  | 18.9                              | 10.2                   | 94       | 200                                |
| EZPV70406MTS | ±10           | 40        | 30.0            | 51.0 | 57.5 | 52.5 | 20.3 | 1.2 | 22           | 880  | 20.9                              | 9.1                    | 97       | 200                                |
| EZPV70456MTS | ±10           | 45        | 30.0            | 51.0 | 57.5 | 52.5 | 20.3 | 1.2 | 22           | 990  | 22.8                              | 7.9                    | 101      | 200                                |
| EZPV70506MTS | ±10           | 50        | 30.0            | 51.0 | 57.5 | 52.5 | 20.3 | 1.2 | 22           | 1100   | 24.5                              | 6.8                    | 110      | 200                                |
| EZPV70556MTS | ±10           | 55        | 35.0            | 50.0 | 57.5 | 52.5 | 20.3 | 1.2 | 22           | 1210   | 26.2                              | 6.3                    | 122      | 200                                |
| EZPV70606MTS | ±10           | 60        | 35.0            | 56.0 | 57.5 | 52.5 | 20.3 | 1.2 | 22           | 1320   | 27.8                              | 6.2                    | 137      | 200                                |
| EZPV70656MTS | ±10           | 65        | 35.0            | 64.5 | 57.5 | 52.5 | 20.3 | 1.2 | 22           | 1430   | 29.3                              | 6.2                    | 140      | 200                                |

\*1 : When rising temperature of capacitor surface by continuous peak current(included pulse current), use within limit specified for temperature of capacitor surface and self heating temperature rise.

\*2 : Maximum RMS current @ 70°C , 10kHz Use within limit for self heating temperature rise at capacitor surface.

\*3 : 20 °C、10 kHz

\*4 : Minimum order quantity consists of 4 packing units.



## Rating · Dimensions · Quantity

## For automotive

■ Rated voltage [DC] : 800 V

| Part No.                | Cap. Tol. (%) | Cap. (μF) | Dimensions (mm) |      |      |      |      |     | dv/dt (V/μs) | Permissible current                            |                                   | ESR <sup>*3</sup> (mΩ) | Mass (g) | Min. order Q'ty <sup>*4</sup> (PCS) |
|-------------------------|---------------|-----------|-----------------|------|------|------|------|-----|--------------|--|-----------------------------------|------------------------|----------|-------------------------------------|
|                         |               |           | W               | H    | L    | P1   | P2   | ∅   |              | Peak current <sup>*1</sup> (A <sub>0-P</sub> ) | RMS current <sup>*2</sup> (A rms) |                        |          |                                     |
| EZPV80905LTU            | ±10           | 9         | 20.5            | 41.5 | 31.0 | 27.5 | -    | 0.8 | 35           | 315  | 12.3                              | 12.6                   | 30       | 800                                 |
| <b>NEW</b> EZPV80905MTU | ±10           | 9         | 20.5            | 41.5 | 31.0 | 27.5 | 10.2 | 0.8 | 35           | 315  | 12.3                              | 12.6                   | 30       | 800                                 |
| EZPV80106LTU            | ±10           | 10        | 20.5            | 41.5 | 31.0 | 27.5 | -    | 0.8 | 35           | 350  | 12.9                              | 11.5                   | 31       | 800                                 |
| <b>NEW</b> EZPV80106MTU | ±10           | 10        | 20.5            | 41.5 | 31.0 | 27.5 | 10.2 | 0.8 | 35           | 350  | 12.9                              | 11.5                   | 31       | 800                                 |
| EZPV80116LTU            | ±10           | 11        | 20.5            | 41.5 | 31.0 | 27.5 | -    | 0.8 | 35           | 385  | 13.6                              | 10.6                   | 32       | 800                                 |
| <b>NEW</b> EZPV80116MTU | ±10           | 11        | 20.5            | 41.5 | 31.0 | 27.5 | 10.2 | 0.8 | 35           | 385  | 13.6                              | 10.6                   | 32       | 800                                 |
| EZPV80126LTU            | ±10           | 12        | 20.5            | 41.5 | 31.0 | 27.5 | -    | 0.8 | 35           | 420  | 14.2                              | 9.9                    | 33       | 800                                 |
| <b>NEW</b> EZPV80126MTU | ±10           | 12        | 20.5            | 41.5 | 31.0 | 27.5 | 10.2 | 0.8 | 35           | 420  | 14.2                              | 9.9                    | 33       | 800                                 |
| EZPV80136LTU            | ±10           | 13        | 26.0            | 41.0 | 31.0 | 27.5 | -    | 1.0 | 35           | 455  | 14.7                              | 9.2                    | 42       | 600                                 |
| <b>NEW</b> EZPV80136MTU | ±10           | 13        | 26.0            | 41.0 | 31.0 | 27.5 | 10.2 | 1.0 | 35           | 455  | 14.7                              | 9.2                    | 42       | 600                                 |
| EZPV80146LTU            | ±10           | 14        | 26.0            | 41.0 | 31.0 | 27.5 | -    | 1.0 | 35           | 490  | 15.3                              | 8.7                    | 42       | 600                                 |
| <b>NEW</b> EZPV80146MTU | ±10           | 14        | 26.0            | 41.0 | 31.0 | 27.5 | 10.2 | 1.0 | 35           | 490  | 15.3                              | 8.7                    | 42       | 600                                 |
| EZPV80186LTU            | ±10           | 18        | 22.0            | 53.5 | 31.0 | 27.5 | -    | 1.2 | 35           | 630  | 17.3                              | 7.8                    | 54       | 600                                 |
| <b>NEW</b> EZPV80186MTU | ±10           | 18        | 22.0            | 53.5 | 31.0 | 27.5 | 10.2 | 1.2 | 35           | 630  | 17.3                              | 7.8                    | 54       | 600                                 |
| EZPV80805LTT            | ±10           | 8         | 17.0            | 34.5 | 41.0 | 37.5 | -    | 1.0 | 35           | 280  | 8.2                               | 17.1                   | 28       | 1200                                |
| EZPV80905LTT            | ±10           | 9         | 17.0            | 34.5 | 41.0 | 37.5 | -    | 1.0 | 35           | 315  | 8.9                               | 15.6                   | 28       | 1200                                |
| EZPV80106LTT            | ±10           | 10        | 17.0            | 34.5 | 41.0 | 37.5 | -    | 1.0 | 35           | 350  | 9.5                               | 13.9                   | 30       | 1200                                |
| EZPV80126LTT            | ±10           | 12        | 22.0            | 36.0 | 41.0 | 37.5 | -    | 1.0 | 35           | 420  | 10.7                              | 12.5                   | 39       | 600                                 |
| EZPV80156MTT            | ±10           | 15        | 22.0            | 36.0 | 41.0 | 37.5 | 10.2 | 1.0 | 35           | 525  | 13.0                              | 10.2                   | 42       | 600                                 |
| EZPV80206MTT            | ±10           | 20        | 26.0            | 40.5 | 41.0 | 37.5 | 10.2 | 1.0 | 35           | 700  | 15.8                              | 8.7                    | 55       | 600                                 |
| EZPV80256MTT            | ±10           | 25        | 30.0            | 50.5 | 41.0 | 37.5 | 10.2 | 1.0 | 35           | 875  | 18.3                              | 8.7                    | 70       | 400                                 |
| EZPV80306MTT            | ±10           | 30        | 30.0            | 50.5 | 41.0 | 37.5 | 20.3 | 1.0 | 35           | 1050   | 20.6                              | 7.1                    | 74       | 400                                 |
| EZPV80356MTT            | ±10           | 35        | 30.0            | 56.0 | 41.5 | 37.5 | 20.3 | 1.2 | 35           | 1225   | 22.7                              | 5.5                    | 86       | 400                                 |
| EZPV80406MTT            | ±10           | 40        | 38.0            | 52.5 | 42.0 | 37.5 | 20.3 | 1.2 | 35           | 1400   | 24.6                              | 5.1                    | 108      | 400                                 |
| EZPV80456MTT            | ±10           | 45        | 38.0            | 57.0 | 42.0 | 37.5 | 20.3 | 1.2 | 35           | 1575   | 26.4                              | 4.5                    | 117      | 400                                 |
| EZPV80506MTT            | ±10           | 50        | 43.0            | 58.0 | 41.0 | 37.5 | 20.3 | 1.2 | 35           | 1750   | 28.2                              | 4.8                    | 132      | 400                                 |
| EZPV80256MTS            | ±10           | 25        | 25.0            | 40.0 | 57.0 | 52.5 | 10.2 | 1.2 | 22           | 550  | 14.4                              | 11.6                   | 68       | 600                                 |
| EZPV80306MTS            | ±10           | 30        | 30.0            | 51.0 | 57.5 | 52.5 | 10.2 | 1.2 | 22           | 660  | 16.8                              | 11.6                   | 91       | 200                                 |
| EZPV80356MTS            | ±10           | 35        | 30.0            | 51.0 | 57.5 | 52.5 | 10.2 | 1.2 | 22           | 770  | 18.9                              | 10.2                   | 94       | 200                                 |
| EZPV80406MTS            | ±10           | 40        | 30.0            | 51.0 | 57.5 | 52.5 | 20.3 | 1.2 | 22           | 880  | 20.9                              | 9.1                    | 97       | 200                                 |
| EZPV80456MTS            | ±10           | 45        | 30.0            | 51.0 | 57.5 | 52.5 | 20.3 | 1.2 | 22           | 990  | 22.8                              | 7.9                    | 101      | 200                                 |
| EZPV80506MTS            | ±10           | 50        | 30.0            | 51.0 | 57.5 | 52.5 | 20.3 | 1.2 | 22           | 1100   | 24.5                              | 6.8                    | 110      | 200                                 |
| EZPV80556MTS            | ±10           | 55        | 35.0            | 50.0 | 57.5 | 52.5 | 20.3 | 1.2 | 22           | 1210   | 26.2                              | 6.3                    | 122      | 200                                 |
| EZPV80606MTS            | ±10           | 60        | 35.0            | 56.0 | 57.5 | 52.5 | 20.3 | 1.2 | 22           | 1320   | 27.8                              | 6.2                    | 137      | 200                                 |
| EZPV80656MTS            | ±10           | 65        | 35.0            | 64.5 | 57.5 | 52.5 | 20.3 | 1.2 | 22           | 1430   | 29.3                              | 6.2                    | 140      | 200                                 |

\*1 : When rising temperature of capacitor surface by continuous peak current(included pulse current), use within limit specified for temperature of capacitor surface and self heating temperature rise.

\*2 : Maximum RMS current @ 70°C , 10kHz Use within limit for self heating temperature rise at capacitor surface.

\*3 : 20 °C、10 kHz

\*4 : Minimum order quantity consists of 4 packing units.

## Rating · Dimensions · Quantity

For automotive

■ Rated voltage [DC] : 1000 V

**NEW**

| Part No.     | Cap. Tol. (%) | Cap. (μF) | Dimensions (mm) |      |      |      |      |     | dv/dt (V/μs) | Permissible current                            |                                   | ESR <sup>*3</sup> (mΩ) | Mass (g) | Min. order Qty <sup>*4</sup> (PCS) |
|--------------|---------------|-----------|-----------------|------|------|------|------|-----|--------------|--|-----------------------------------|------------------------|----------|------------------------------------|
|              |               |           | W               | H    | L    | P1   | P2   | ∅   |              | Peak current <sup>*1</sup> (A <sub>0-P</sub> ) | RMS current <sup>*2</sup> (A rms) |                        |          |                                    |
| EZPV1A305LTT | ±10           | 3         | 15.0            | 29.0 | 41.0 | 37.5 | -    | 1.0 | 50           | 150  | 4.4                               | 30.8                   | 22       | 1200                               |
| EZPV1A405LTT | ±10           | 4         | 15.0            | 29.0 | 41.0 | 37.5 | -    | 1.0 | 50           | 200  | 5.5                               | 23.5                   | 23       | 1200                               |
| EZPV1A475LTT | ±10           | 4.7       | 17.0            | 34.5 | 41.0 | 37.5 | -    | 1.0 | 50           | 235  | 6.2                               | 21.7                   | 28       | 1200                               |
| EZPV1A505LTT | ±10           | 5         | 17.0            | 34.5 | 41.0 | 37.5 | -    | 1.0 | 50           | 250  | 6.5                               | 20.4                   | 28       | 1200                               |
| EZPV1A605LTT | ±10           | 6         | 17.0            | 34.5 | 41.0 | 37.5 | -    | 1.0 | 50           | 300  | 7.3                               | 17.5                   | 29       | 1200                               |
| EZPV1A705MTT | ±10           | 7         | 22.0            | 36.0 | 41.0 | 37.5 | 10.2 | 1.0 | 50           | 350  | 8.5                               | 15.5                   | 39       | 600                                |
| EZPV1A805MTT | ±10           | 8         | 22.0            | 36.0 | 41.0 | 37.5 | 10.2 | 1.0 | 50           | 400  | 9.5                               | 13.7                   | 41       | 600                                |
| EZPV1A905MTT | ±10           | 9         | 22.0            | 36.0 | 41.0 | 37.5 | 10.2 | 1.0 | 50           | 450  | 10.4                              | 12.4                   | 42       | 600                                |
| EZPV1A106MTT | ±10           | 10        | 23.5            | 43.5 | 41.5 | 37.5 | 10.2 | 1.0 | 50           | 500  | 11.2                              | 12.7                   | 48       | 400                                |
| EZPV1A126MTT | ±10           | 12        | 26.0            | 40.5 | 41.0 | 37.5 | 10.2 | 1.0 | 50           | 600  | 12.8                              | 10.4                   | 55       | 600                                |
| EZPV1A156MTT | ±10           | 15        | 30.0            | 50.5 | 41.0 | 37.5 | 10.2 | 1.0 | 50           | 750  | 15.0                              | 10.4                   | 70       | 400                                |
| EZPV1A186MTT | ±10           | 18        | 30.0            | 50.5 | 41.0 | 37.5 | 20.3 | 1.0 | 50           | 900  | 16.9                              | 8.5                    | 74       | 400                                |
| EZPV1A206MTT | ±10           | 20        | 30.0            | 56.0 | 41.5 | 37.5 | 20.3 | 1.2 | 50           | 1000   | 18.1                              | 7.2                    | 82       | 400                                |
| EZPV1A256MTT | ±10           | 25        | 38.0            | 52.5 | 42.0 | 37.5 | 20.3 | 1.2 | 50           | 1250   | 20.9                              | 5.9                    | 108      | 400                                |
| EZPV1A306MTT | ±10           | 30        | 43.0            | 58.0 | 41.0 | 37.5 | 20.3 | 1.2 | 50           | 1500   | 23.4                              | 5.7                    | 132      | 400                                |
| EZPV1A156MTS | ±10           | 15        | 25.0            | 40.0 | 57.0 | 52.5 | 10.2 | 1.2 | 30           | 450  | 10.6                              | 13.7                   | 67       | 600                                |
| EZPV1A206MTS | ±10           | 20        | 35.5            | 45.5 | 57.5 | 52.5 | 10.2 | 1.2 | 30           | 600  | 12.2                              | 11.2                   | 106      | 200                                |
| EZPV1A256MTS | ±10           | 25        | 35.5            | 45.5 | 57.5 | 52.5 | 20.3 | 1.2 | 30           | 750  | 13.6                              | 9.1                    | 111      | 200                                |
| EZPV1A306MTS | ±10           | 30        | 35.0            | 50.0 | 57.5 | 52.5 | 20.3 | 1.2 | 30           | 900  | 14.9                              | 9.9                    | 116      | 200                                |
| EZPV1A356MTS | ±10           | 35        | 35.0            | 56.0 | 57.5 | 52.5 | 20.3 | 1.2 | 30           | 1050   | 16.1                              | 9.2                    | 132      | 200                                |
| EZPV1A406MTS | ±10           | 40        | 35.0            | 56.0 | 57.5 | 52.5 | 20.3 | 1.2 | 30           | 1200   | 17.2                              | 7.8                    | 138      | 200                                |

\*1 : When rising temperature of capacitor surface by continuous peak current(included pulse current), use within limit specified for temperature of capacitor surface and self heating temperature rise.

\*2 : Maximum RMS current @ 70°C , 10kHz Use within limit for self heating temperature rise at capacitor surface.

\*3 : 20 °C、10 kHz

\*4 : Minimum order quantity consists of 4 packing units.

## Rating · Dimensions · Quantity

## For automotive

■ Rated voltage [DC] : 1100 V

| Part No.     | Cap. Tol. (%) | Cap. (μF) | Dimensions (mm) |      |      |      |      |     | dv/dt (V/μs) | Permissible current                            |                                   | ESR <sup>*3</sup> (mΩ) | Mass (g) | Min. order Qty <sup>*4</sup> (PCS) |
|--------------|---------------|-----------|-----------------|------|------|------|------|-----|--------------|--|-----------------------------------|------------------------|----------|------------------------------------|
|              |               |           | W               | H    | L    | P1   | P2   | ∅   |              | Peak current <sup>*1</sup> (A <sub>0-P</sub> ) | RMS current <sup>*2</sup> (A rms) |                        |          |                                    |
| EZPV1B305LTT | ±10           | 3         | 15.0            | 29.0 | 41.0 | 37.5 | -    | 1.0 | 50           | 150  | 4.4                               | 30.8                   | 22       | 1200                               |
| EZPV1B405LTT | ±10           | 4         | 15.0            | 29.0 | 41.0 | 37.5 | -    | 1.0 | 50           | 200  | 5.5                               | 23.5                   | 23       | 1200                               |
| EZPV1B475LTT | ±10           | 4.7       | 17.0            | 34.5 | 41.0 | 37.5 | -    | 1.0 | 50           | 235  | 6.2                               | 21.7                   | 28       | 1200                               |
| EZPV1B505LTT | ±10           | 5         | 17.0            | 34.5 | 41.0 | 37.5 | -    | 1.0 | 50           | 250  | 6.5                               | 20.4                   | 28       | 1200                               |
| EZPV1B605LTT | ±10           | 6         | 17.0            | 34.5 | 41.0 | 37.5 | -    | 1.0 | 50           | 300  | 7.3                               | 17.5                   | 29       | 1200                               |
| EZPV1B705MTT | ±10           | 7         | 22.0            | 36.0 | 41.0 | 37.5 | 10.2 | 1.0 | 50           | 350  | 8.5                               | 15.5                   | 39       | 600                                |
| EZPV1B805MTT | ±10           | 8         | 22.0            | 36.0 | 41.0 | 37.5 | 10.2 | 1.0 | 50           | 400  | 9.5                               | 13.7                   | 41       | 600                                |
| EZPV1B905MTT | ±10           | 9         | 22.0            | 36.0 | 41.0 | 37.5 | 10.2 | 1.0 | 50           | 450  | 10.4                              | 12.4                   | 42       | 600                                |
| EZPV1B106MTT | ±10           | 10        | 23.5            | 43.5 | 41.5 | 37.5 | 10.2 | 1.0 | 50           | 500  | 11.2                              | 12.7                   | 48       | 400                                |
| EZPV1B126MTT | ±10           | 12        | 26.0            | 40.5 | 41.0 | 37.5 | 10.2 | 1.0 | 50           | 600  | 12.8                              | 10.4                   | 55       | 600                                |
| EZPV1B156MTT | ±10           | 15        | 30.0            | 50.5 | 41.0 | 37.5 | 10.2 | 1.0 | 50           | 750  | 15.0                              | 10.4                   | 70       | 400                                |
| EZPV1B186MTT | ±10           | 18        | 30.0            | 50.5 | 41.0 | 37.5 | 20.3 | 1.0 | 50           | 900  | 16.9                              | 8.5                    | 74       | 400                                |
| EZPV1B206MTT | ±10           | 20        | 30.0            | 56.0 | 41.5 | 37.5 | 20.3 | 1.2 | 50           | 1000   | 18.1                              | 7.2                    | 82       | 400                                |
| EZPV1B256MTT | ±10           | 25        | 38.0            | 52.5 | 42.0 | 37.5 | 20.3 | 1.2 | 50           | 1250   | 20.9                              | 5.9                    | 108      | 400                                |
| EZPV1B306MTT | ±10           | 30        | 43.0            | 58.0 | 41.0 | 37.5 | 20.3 | 1.2 | 50           | 1500   | 23.4                              | 5.7                    | 132      | 400                                |
| EZPV1B156MTS | ±10           | 15        | 25.0            | 40.0 | 57.0 | 52.5 | 10.2 | 1.2 | 30           | 450  | 10.6                              | 13.7                   | 67       | 600                                |
| EZPV1B206MTS | ±10           | 20        | 35.5            | 45.5 | 57.5 | 52.5 | 10.2 | 1.2 | 30           | 600  | 12.2                              | 11.2                   | 106      | 200                                |
| EZPV1B256MTS | ±10           | 25        | 35.5            | 45.5 | 57.5 | 52.5 | 20.3 | 1.2 | 30           | 750  | 13.6                              | 9.1                    | 111      | 200                                |
| EZPV1B306MTS | ±10           | 30        | 35.0            | 50.0 | 57.5 | 52.5 | 20.3 | 1.2 | 30           | 900  | 14.9                              | 9.9                    | 116      | 200                                |
| EZPV1B356MTS | ±10           | 35        | 35.0            | 56.0 | 57.5 | 52.5 | 20.3 | 1.2 | 30           | 1050   | 16.1                              | 9.2                    | 132      | 200                                |
| EZPV1B406MTS | ±10           | 40        | 35.0            | 56.0 | 57.5 | 52.5 | 20.3 | 1.2 | 30           | 1200   | 17.2                              | 7.8                    | 138      | 200                                |

\*1 : When rising temperature of capacitor surface by continuous peak current(included pulse current), use within limit specified for temperature of capacitor surface and self heating temperature rise.

\*2 : Maximum RMS current @ 70°C , 10kHz Use within limit for self heating temperature rise at capacitor surface.

\*3 : 20 °C、10 kHz

\*4 : Minimum order quantity consists of 4 packing units.

**Characteristics data**

■ **Rated voltage [DC] : 600 V**

Electrical characteristics <Typical data >

**Temperature characteristics**

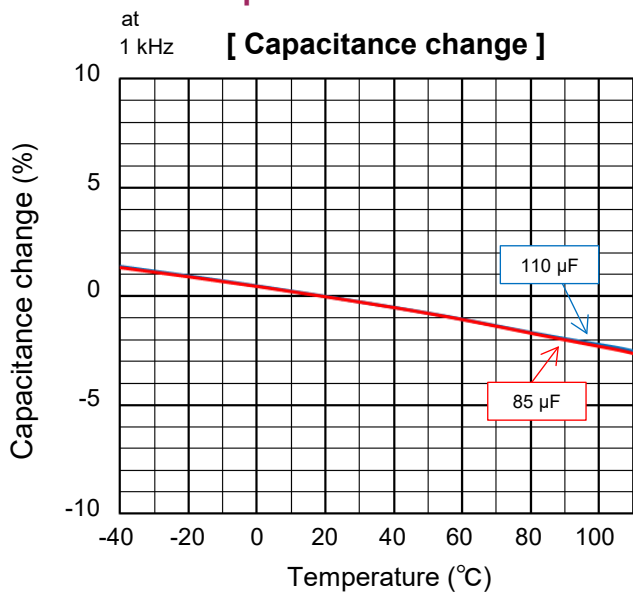

**Frequency characteristics**

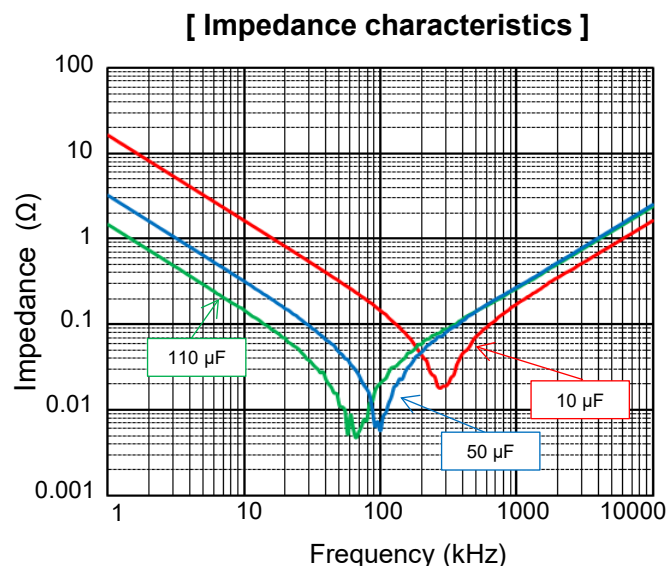
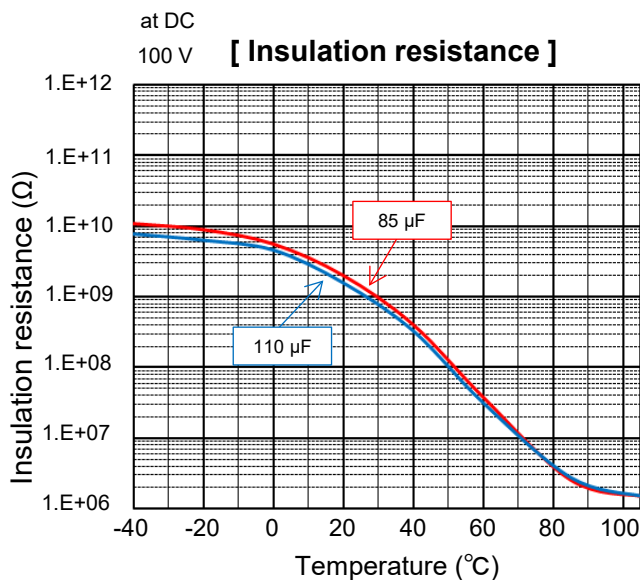
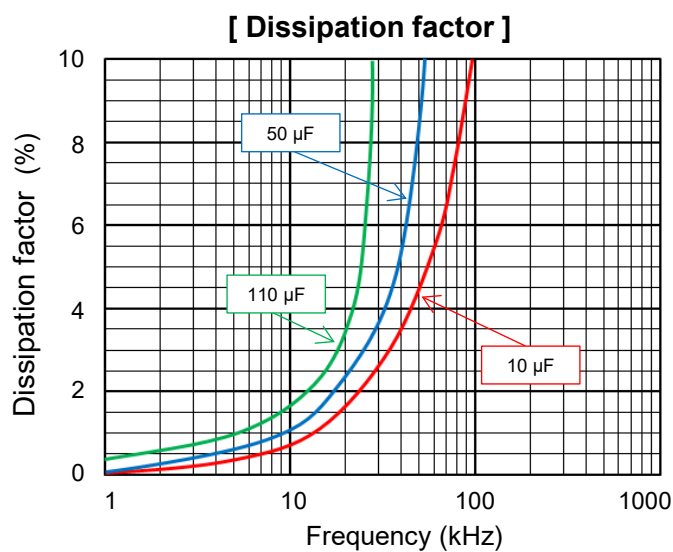
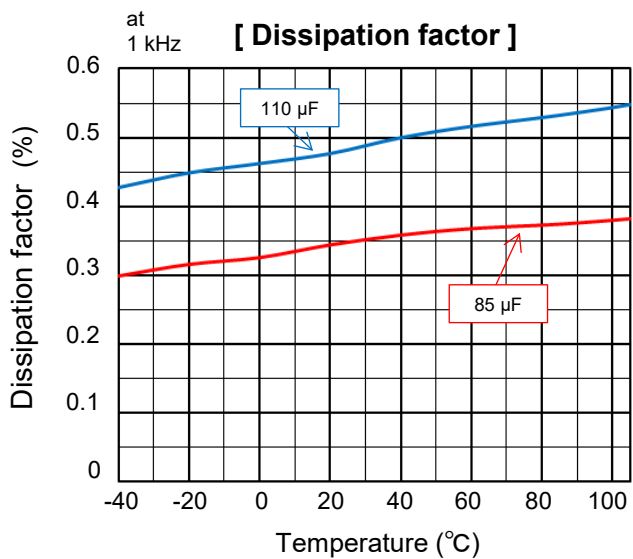
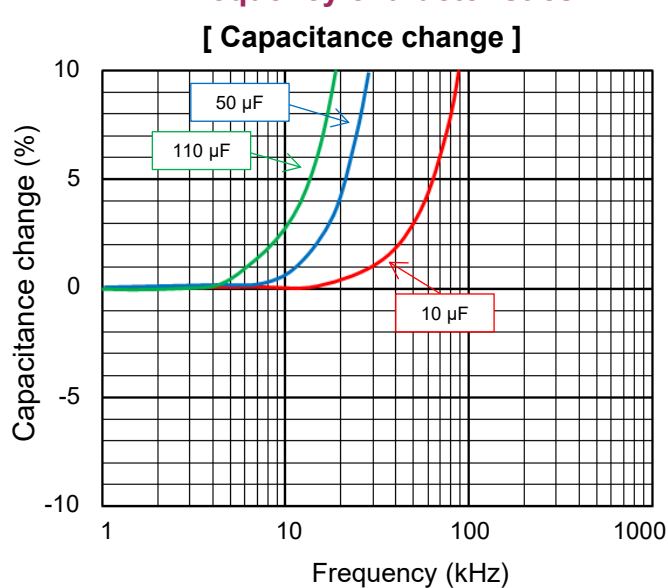

**Characteristics data**

■ Rated voltage [DC] : 600 V

Applicable specifications

**[ Permissible Current ]**

Lead pitch 37.5 mm

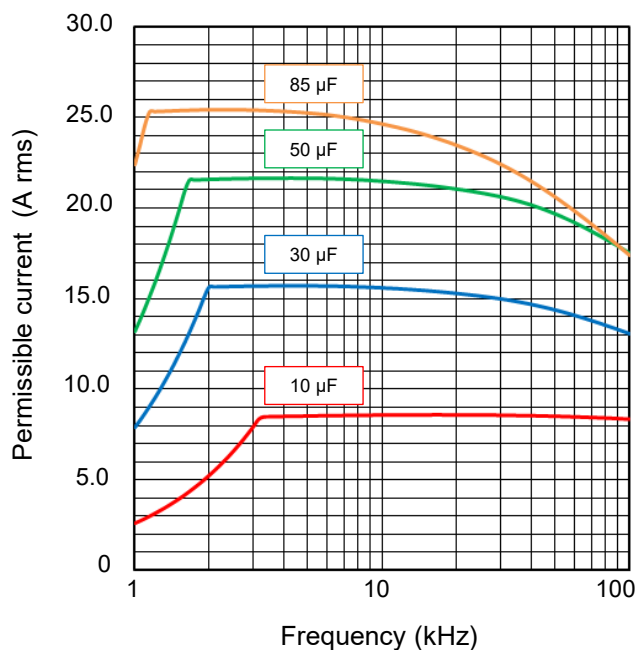

**[ Permissible Current Derating by Temperature ]**

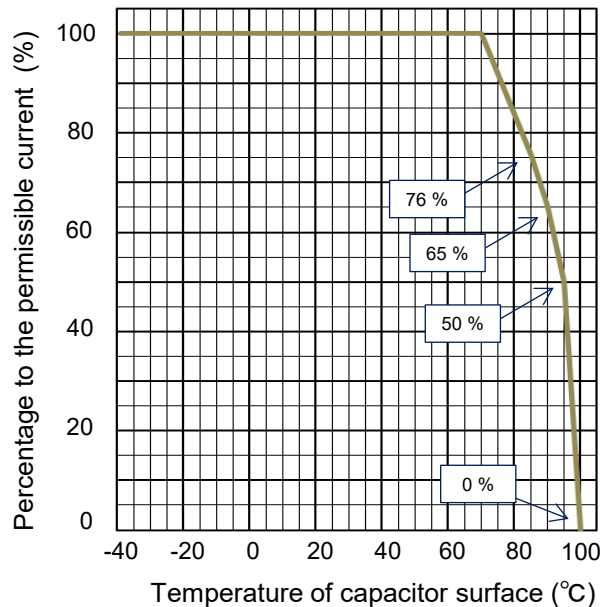

**[ Permissible Current ]**

Lead pitch 52.5 mm

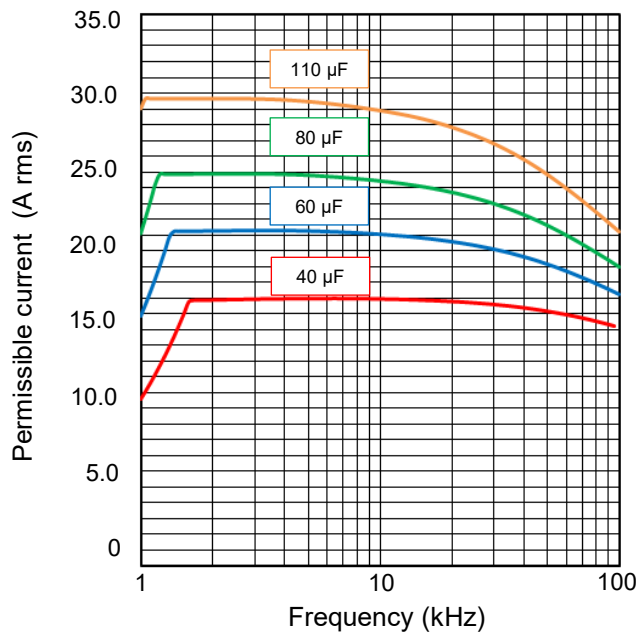

**[ Voltage Derating by Temperature ]**

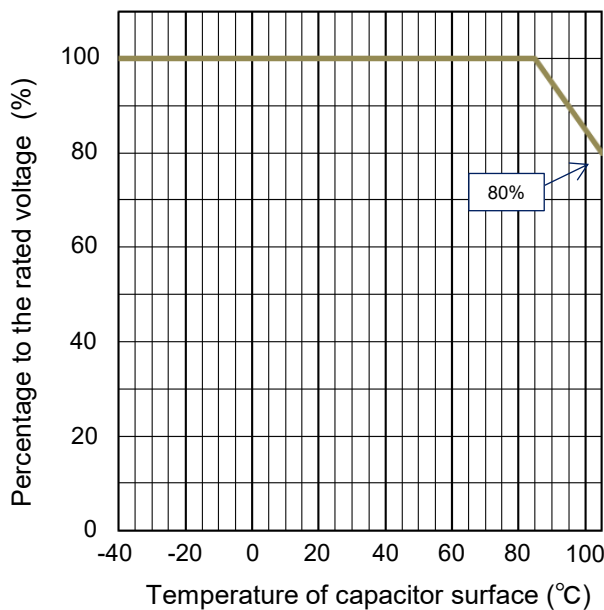

**Permissible pulse current (dV/dt)**  
(Max. 10000 cycles)

| R. voltage [DC] (V) | Pitch (mm) | Capacitance (µF) | Code | dV/dt (V/µs) | Current (Ao-p) |
|---------------------|------------|------------------|------|--------------|----------------|
| 600                 | 37.5       | 10.0             | 106  | 25           | 250.0          |
|                     |            | 30.0             | 306  |              | 750.0          |
|                     |            | 50.0             | 506  |              | 1250.0         |
|                     |            | 70.0             | 706  |              | 1750.0         |
|                     |            | 85.0             | 856  |              | 2125.0         |
|                     | 52.5       | 40.0             | 406  | 15           | 600.0          |
|                     |            | 60.0             | 606  |              | 900.0          |
|                     |            | 80.0             | 806  |              | 1200.0         |
|                     |            | 110.0            | 117  |              | 1650.0         |

**Characteristics data**

■ **Rated voltage [DC] : 700 V / 800 V (Lead pitch 27.5 mm)**

Electrical characteristics <Typical data >

**Temperature characteristics**

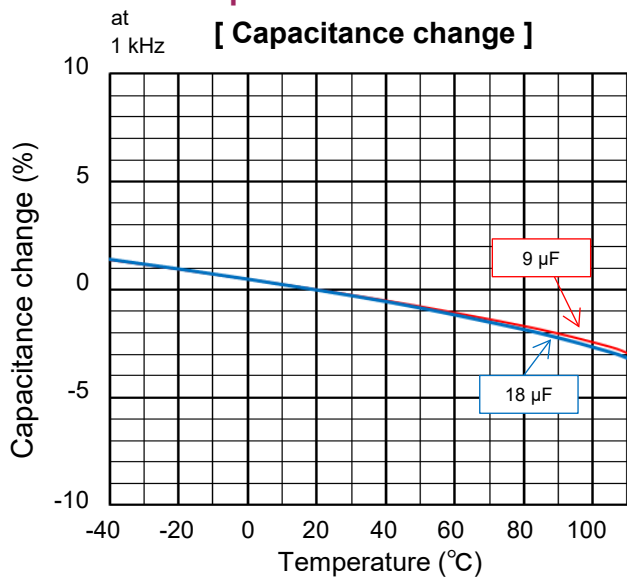

**Frequency characteristics**

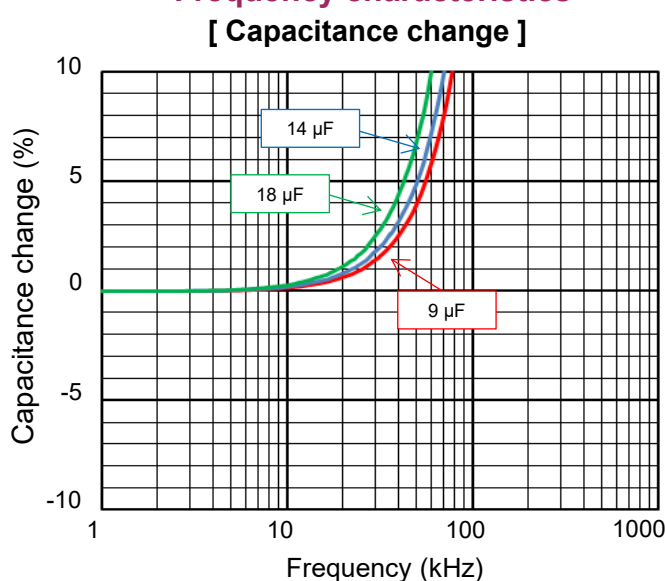

at 1 kHz [ Dissipation factor ]

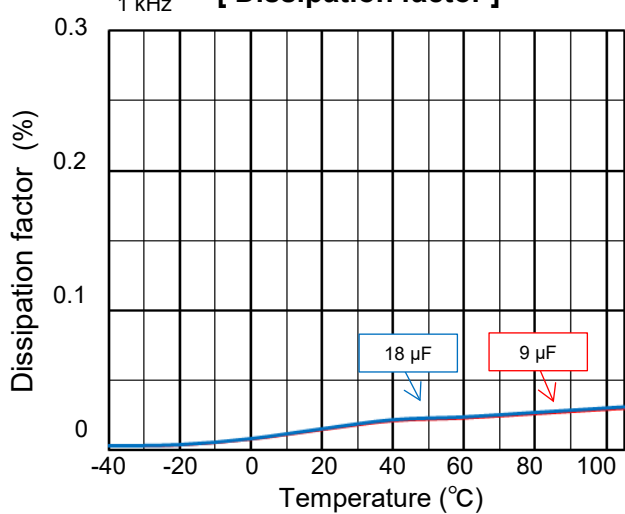

[ Dissipation factor ]

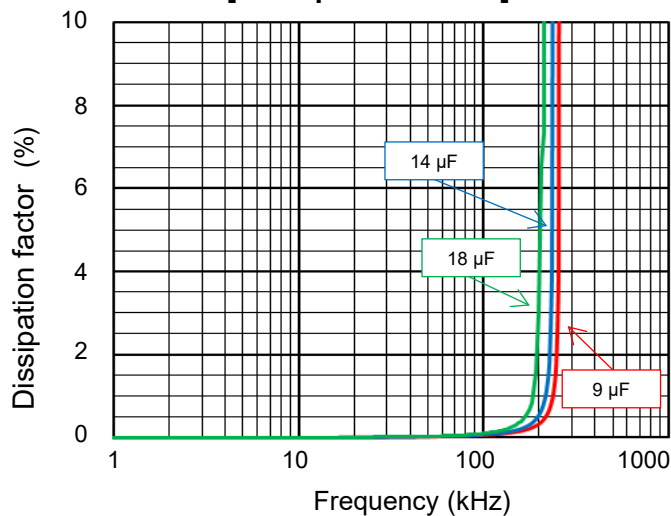

at DC 100 V [ Insulation resistance ]

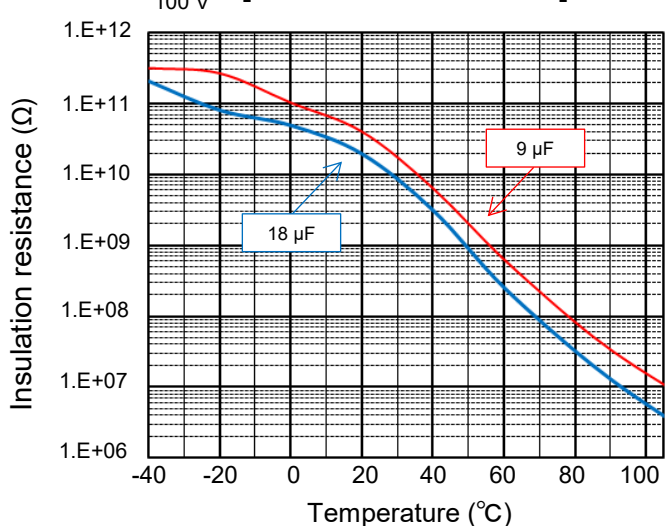

[ Impedance characteristics ]

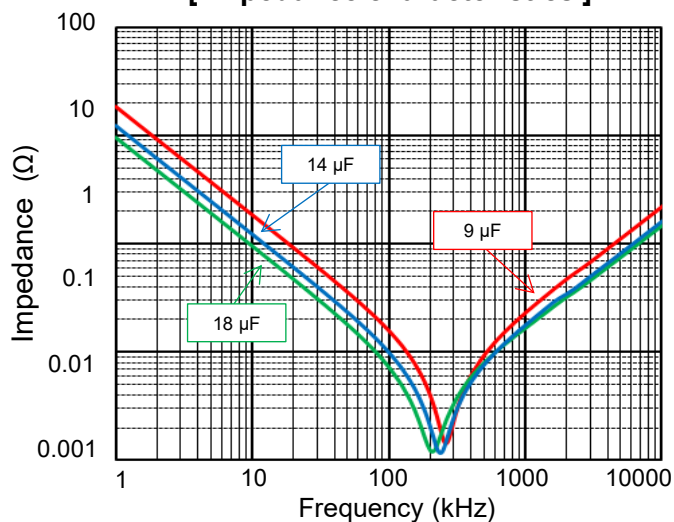

**Characteristics data**

■ **Rated voltage [DC] : 700 V / 800 V (Lead pitch 27.5 mm)**

Applicable specifications

**[ Permissible Current ]**

**Lead pitch 27.5 mm**

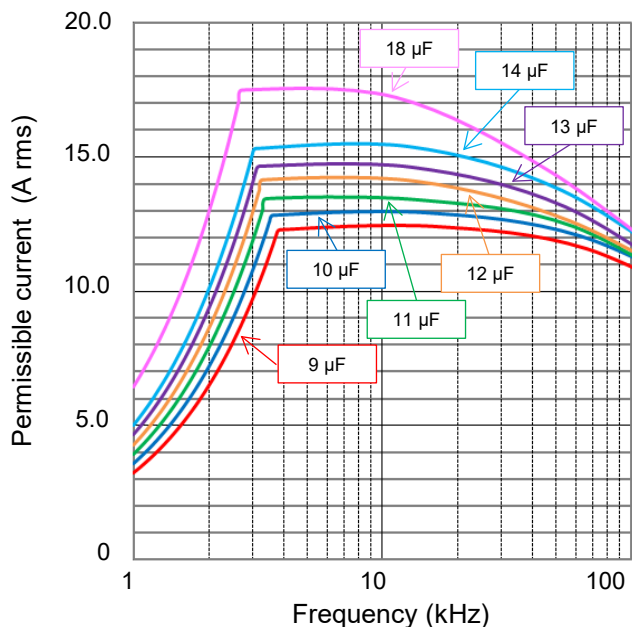

**[ Permissible Current Derating by Temperature ]**

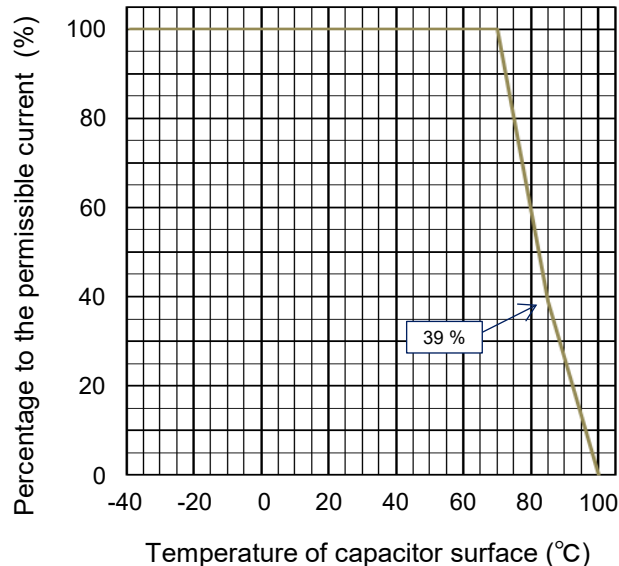

**[ Voltage Derating by Temperature ]**

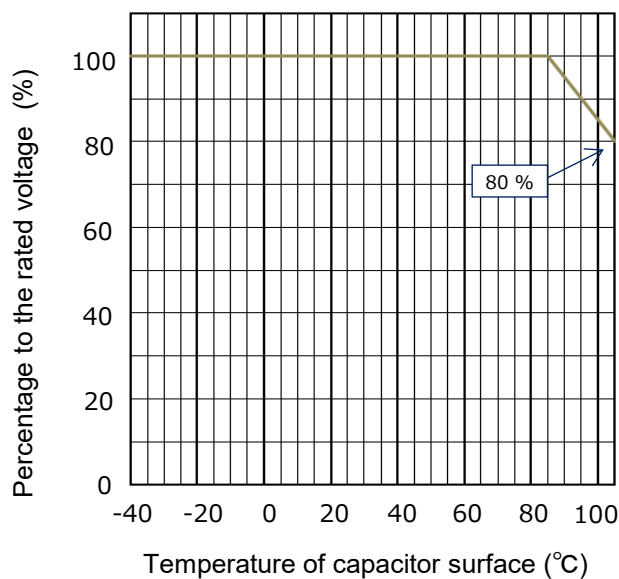

**Permissible pulse current (dV/dt)**  
(Max. 10000 cycles)

| R. voltage [DC] (V) | Pitch (mm) | Capacitance (µF) | Code | dV/dt (V/µs) | Current (A <sub>o-p</sub> ) |
|---------------------|------------|------------------|------|--------------|-----------------------------|
| 700 / 800           | 27.5       | 9.0              | 905  | 35           | 315.0                       |
|                     |            | 10.0             | 106  |              | 350.0                       |
|                     |            | 11.0             | 116  |              | 385.0                       |
|                     |            | 12.0             | 126  |              | 420.0                       |
|                     |            | 13.0             | 136  |              | 455.0                       |
|                     |            | 14.0             | 146  |              | 490.0                       |
|                     |            | 18.0             | 186  |              | 630.0                       |



**Characteristics data**

■ **Rated voltage [DC] : 700 V / 800 V (Lead pitch 37.5 / 52.5 mm)**

Electrical characteristics <Typical data >

**Temperature characteristics**

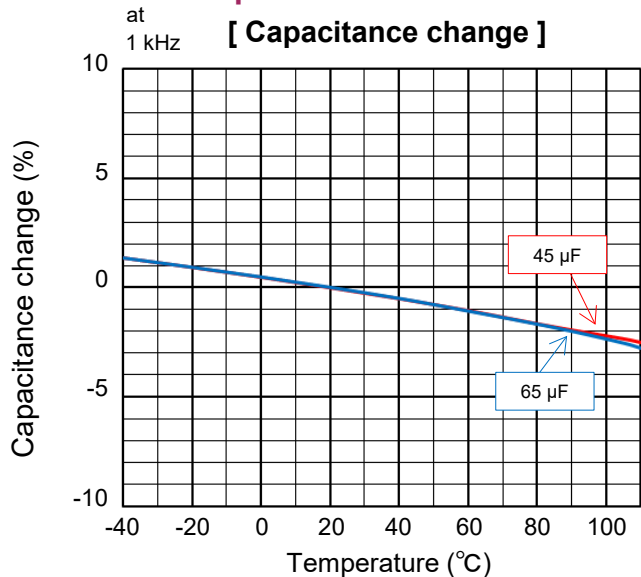

**Frequency characteristics**

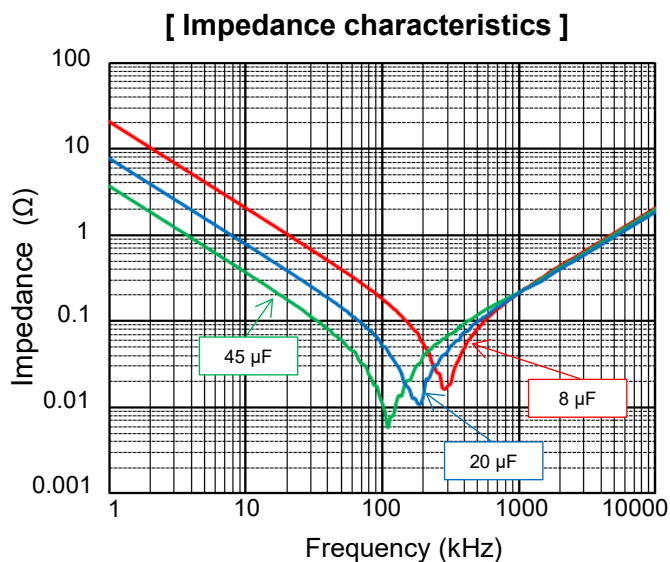
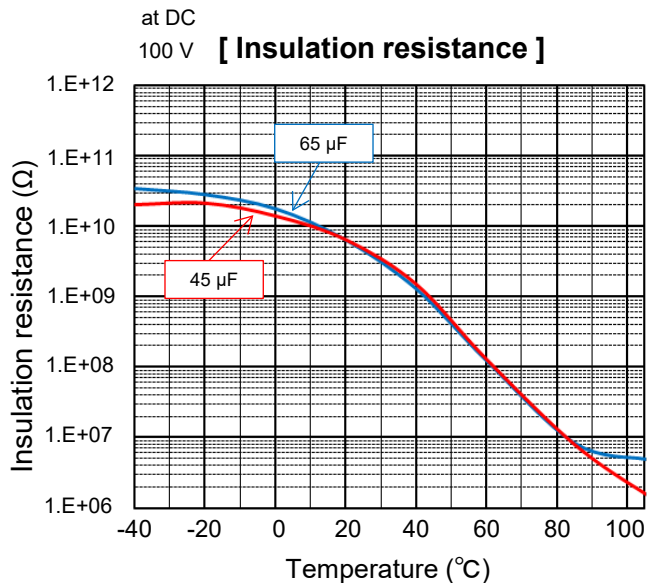
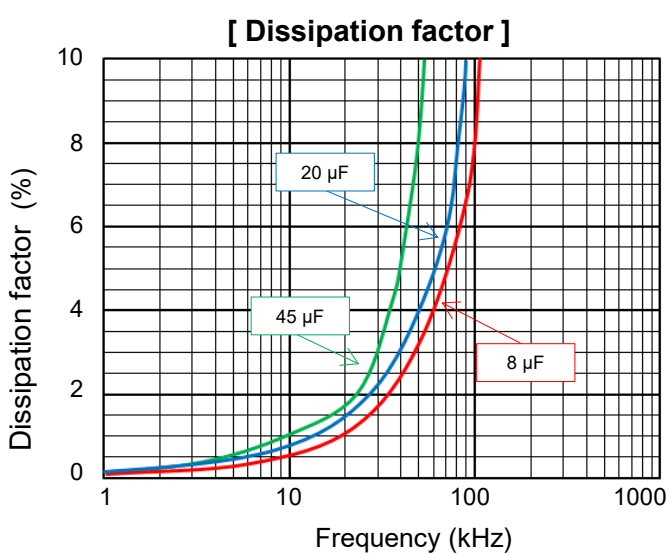
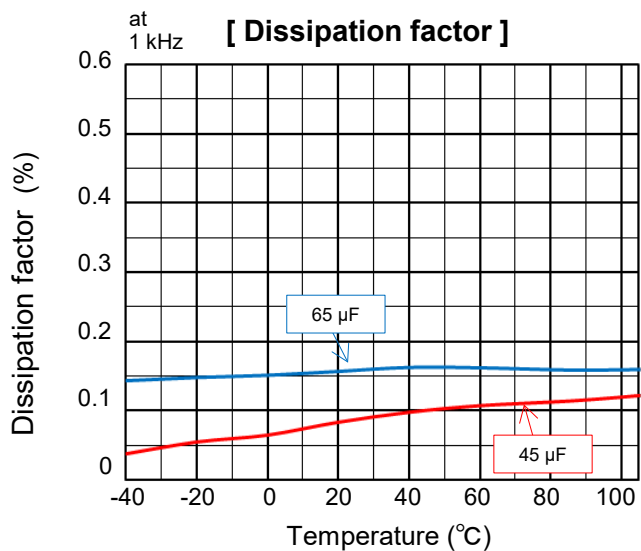
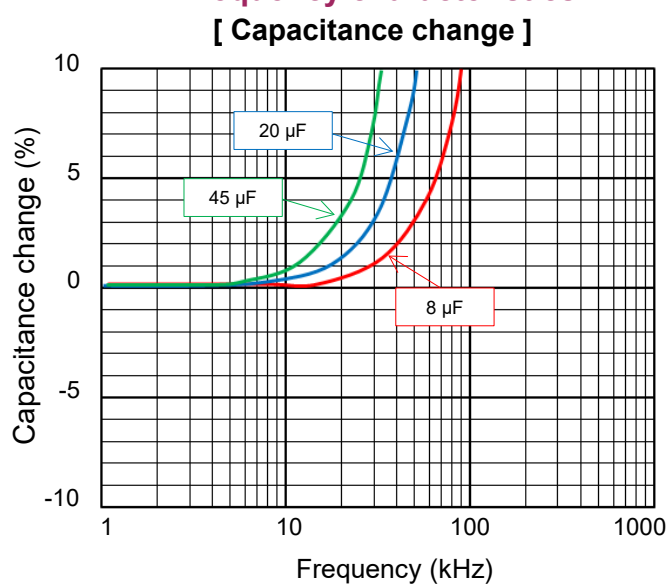



**Characteristics data**

■ **Rated voltage [DC] : 700 V / 800 V (Lead pitch 37.5 / 52.5 mm)**

Applicable specifications

**[ Permissible Current ]**

**Lead pitch 37.5 mm**

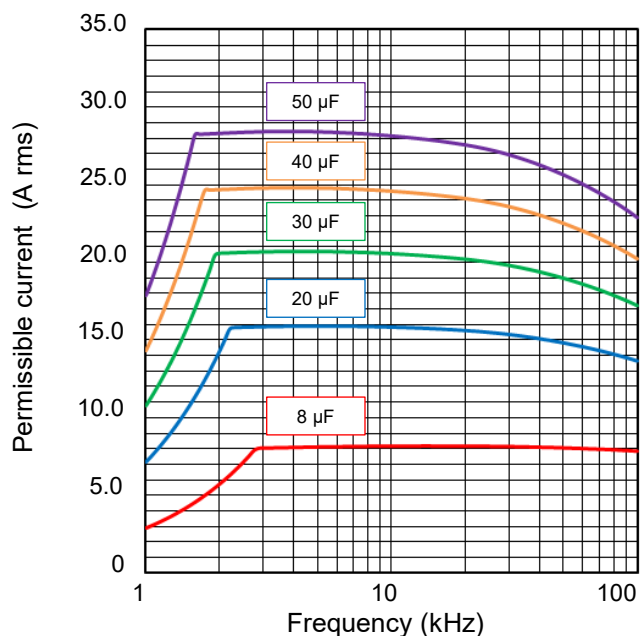

**[ Permissible Current Derating by Temperature ]**

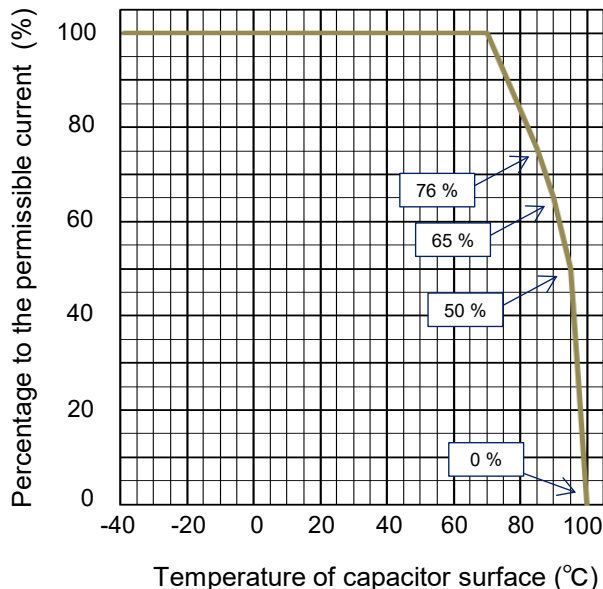

**[ Permissible Current ]**

**Lead pitch 52.5 mm**

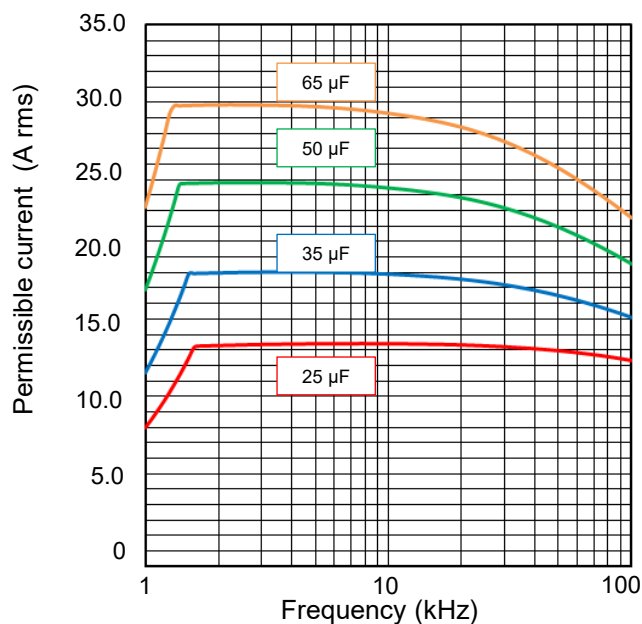

**[ Voltage Derating by Temperature ]**

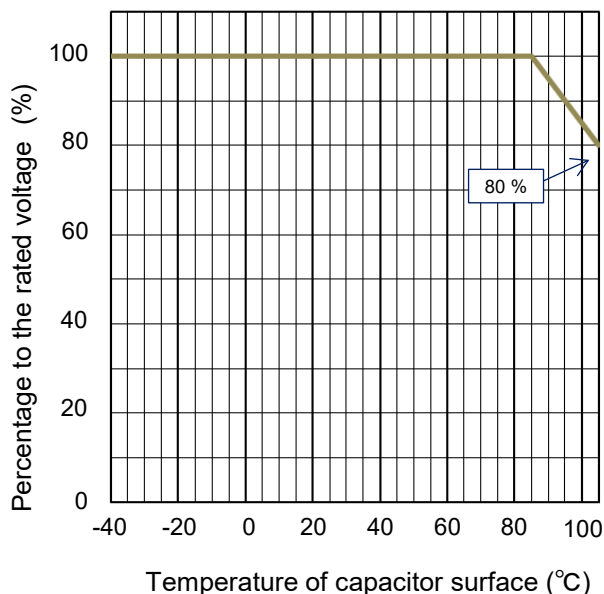

**Permissible pulse current (dV/dt)**  
(Max. 10000 cycles)

| R. voltage [DC] (V) | Pitch (mm) | Capacitance (μF) | Code | dV/dt (V/μs) | Current (A <sub>o-p</sub> ) |
|---------------------|------------|------------------|------|--------------|-----------------------------|
| 700 / 800           | 37.5       | 8.0              | 805  | 35           | 280.0                       |
|                     |            | 20.0             | 206  |              | 700.0                       |
|                     |            | 30.0             | 306  |              | 1050.0                      |
|                     |            | 40.0             | 406  |              | 1400.0                      |
|                     |            | 50.0             | 506  |              | 1750.0                      |
|                     | 52.5       | 25.0             | 256  | 22           | 550.0                       |
|                     |            | 35.0             | 356  |              | 770.0                       |
|                     |            | 50.0             | 506  |              | 1100.0                      |
|                     |            | 65.0             | 656  |              | 1430.0                      |

**Characteristics data**

■ **Rated voltage [DC] : 1000 V / 1100 V**

Electrical characteristics <Typical data >

**Temperature characteristics**

at 1 kHz [Capacitance change]

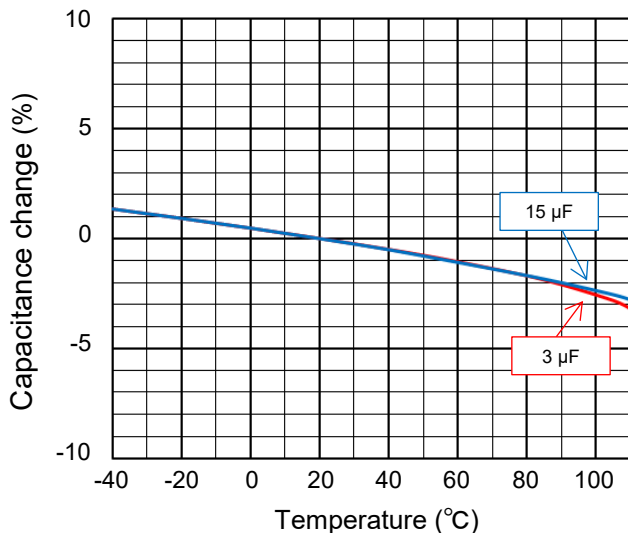

**Frequency characteristics**

[Capacitance change]

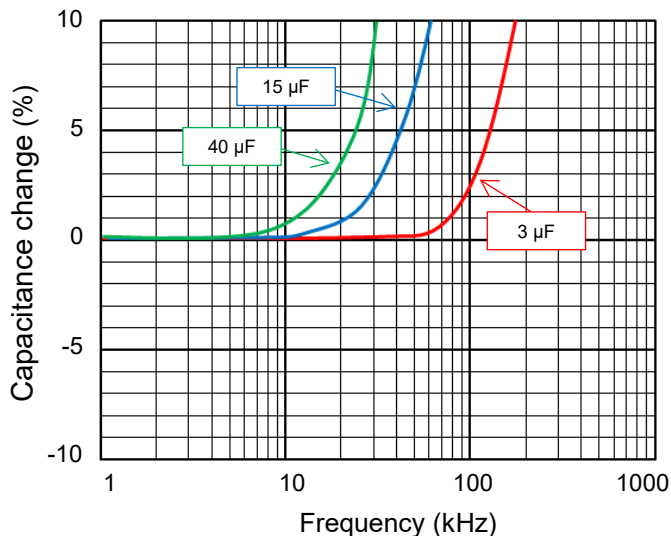

at 1 kHz [Dissipation factor]

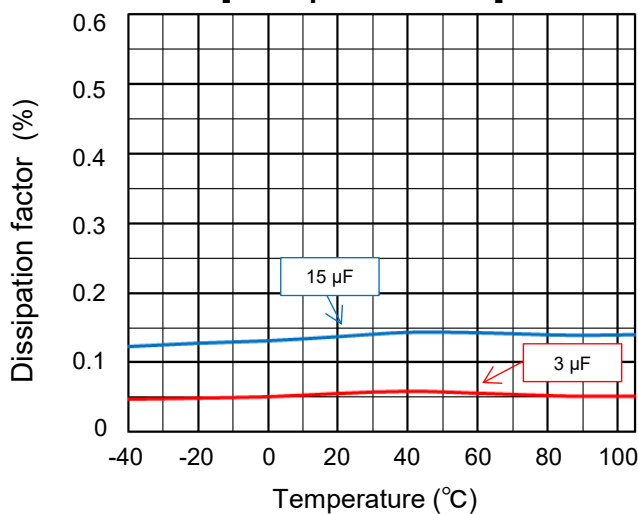

[Dissipation factor]

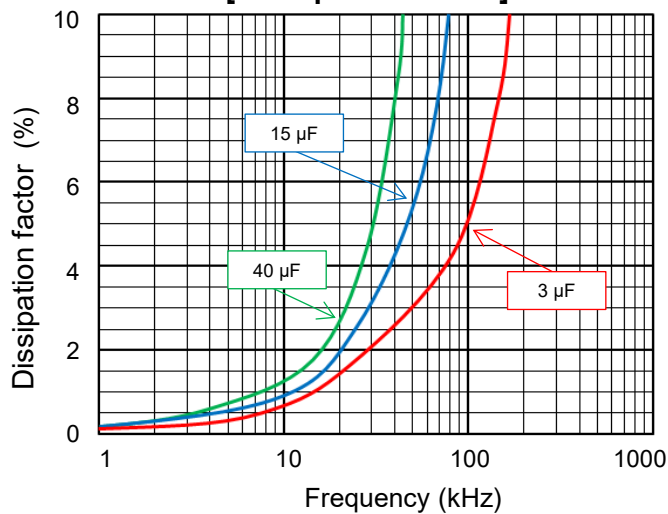

at DC 100 V [Insulation resistance]

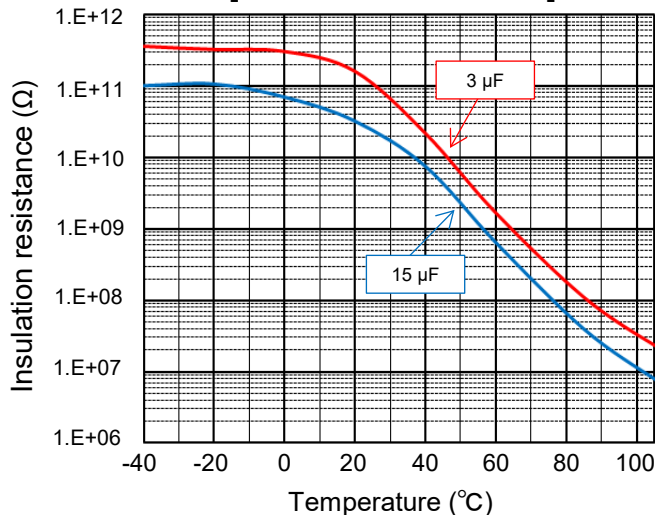

[Impedance characteristics]

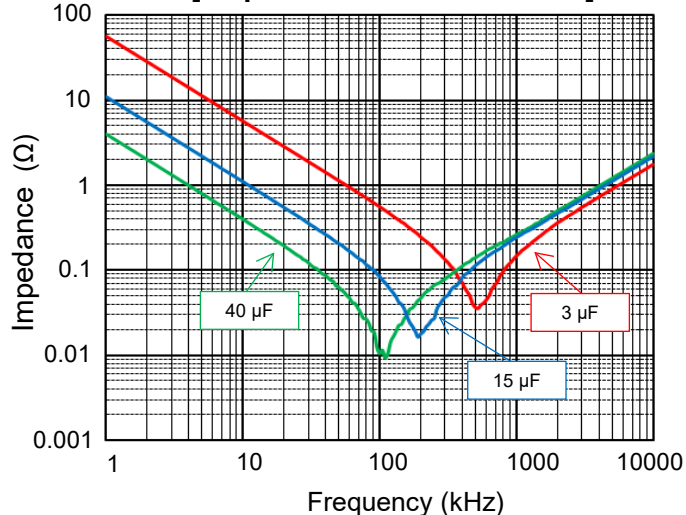

**Characteristics data**

■ **Rated voltage [DC] : 1000 V / 1100 V**

Applicable specifications

[ Permissible Current ]

Lead pitch 37.5 mm

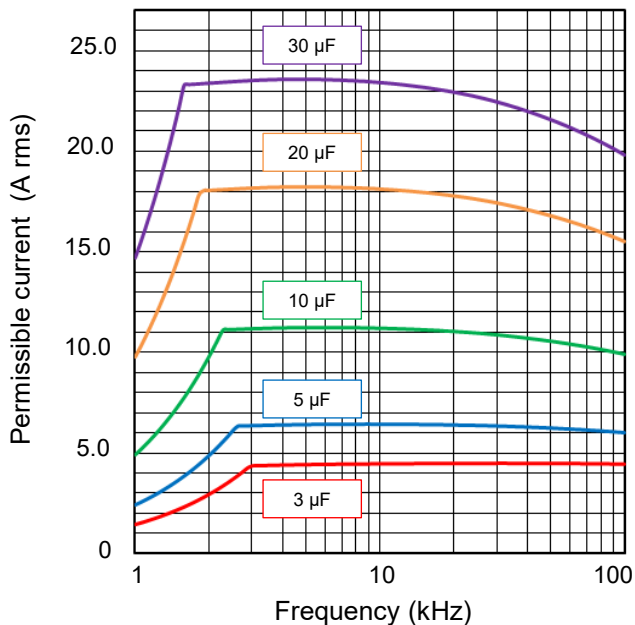

[ Permissible Current Derating by Temperature ]

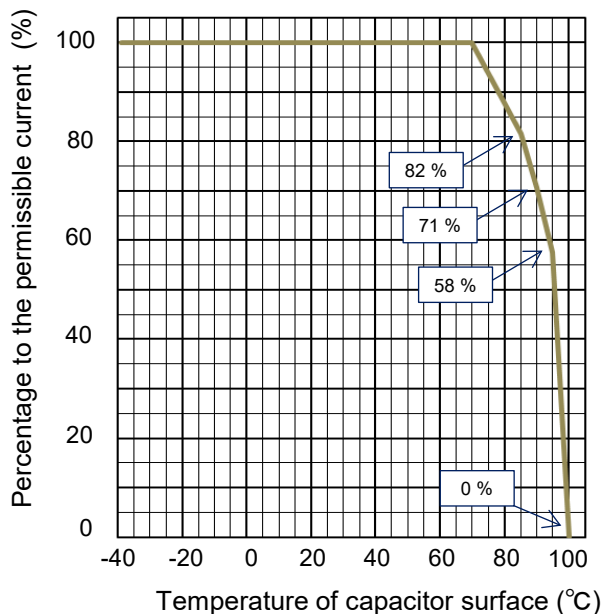

[ Permissible Current ]

Lead pitch 52.5 mm

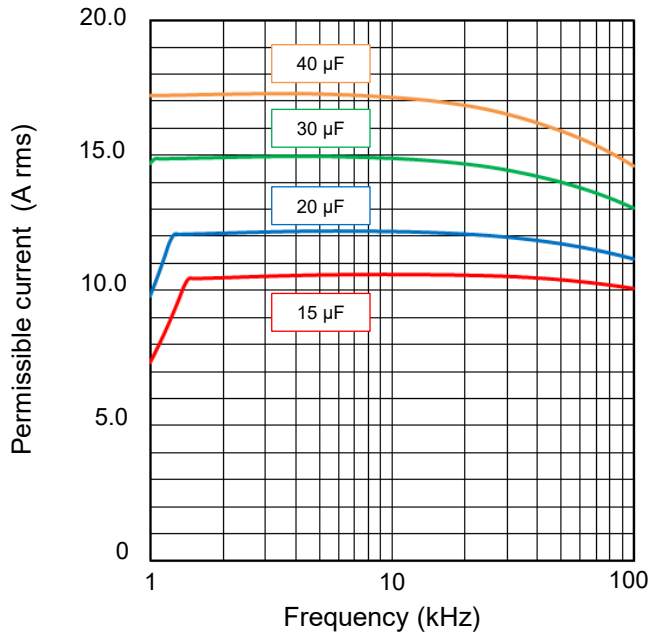

[ Voltage Derating by Temperature ]

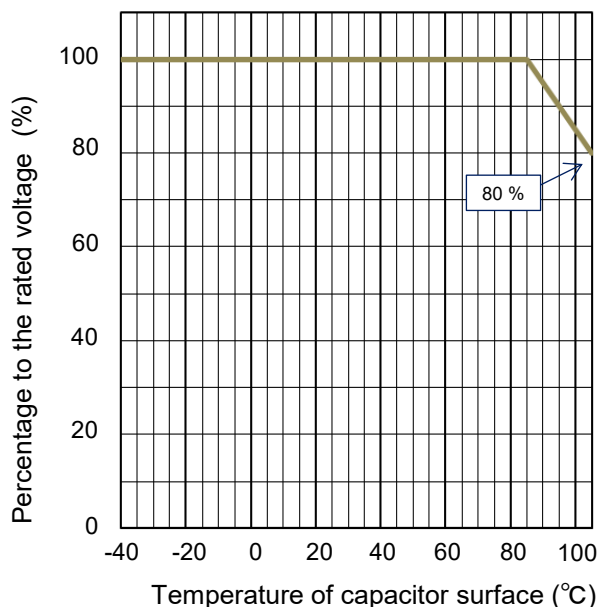

**Permissible pulse current (dV/dt)**  
(Max. 10000 cycles)

| R. voltage [DC] (V) | Pitch (mm) | Capacitance (μF) | Code | dV/dt (V/μs) | Current (A <sub>o-p</sub> ) |
|---------------------|------------|------------------|------|--------------|-----------------------------|
| 1000 / 1100         | 37.5       | 3.0              | 305  | 50           | 150.0                       |
|                     |            | 5.0              | 505  |              | 250.0                       |
|                     |            | 10.0             | 106  |              | 500.0                       |
|                     |            | 20.0             | 206  |              | 1000.0                      |
|                     |            | 30.0             | 306  |              | 1500.0                      |
|                     | 52.5       | 15.0             | 156  | 30           | 450.0                       |
|                     |            | 20.0             | 206  |              | 600.0                       |
|                     |            | 30.0             | 306  |              | 900.0                       |
|                     |            | 40.0             | 406  |              | 1200.0                      |

## Safety and Legal Matters to Be Observed

### Product specifications and applications

- Please be advised that this product and product specifications are subject to change without notice for improvement purposes. Therefore, please request and confirm the latest delivery specifications that explain the specifications in detail before the final design, or purchase or use of the product, regardless of the application. In addition, do not use this product in any way that deviates from the contents of the company's delivery specifications.
- Unless otherwise specified in this catalog or the delivery specifications, this product is intended for use in general electronic equipment (AV products, home appliances, commercial equipment, office equipment, information and communication equipment, etc.).  
When this product is used for the following special cases, please separately discuss the delivery specifications suited to each application with the company. These include applications requiring special quality and reliability, wherein their failures or malfunctions may directly threaten human life or cause harm to the human body (e.g.: space/aircraft equipment, transportation/traffic equipment, combustion equipment, medical equipment, disaster prevention/crime prevention equipment, safety equipment, etc.).

### Safety design and product evaluation

- Please ensure safety through protection circuits, redundant circuits, etc., in the customer's system design so that a defect in our company's product will not endanger human life or cause other serious damage.
- This catalog shows the quality and performance of individual parts. The durability of parts varies depending on the usage environment and conditions. Therefore, please ensure to evaluate and confirm the state of each part after it has been mounted in your product in the actual operating environment before use.  
If you have any doubts about the safety of this product, then please notify us immediately, and be sure to conduct a technical review including the above protection circuits and redundant circuits at your company.

### Laws / Regulations / Intellectual property

- The transportation of dangerous goods as designated by UN numbers, UN classifications, etc., does not apply to this product. In addition, when exporting products, product specifications, and technical information described in this catalog, please comply with the laws and regulations of the countries to which the products are exported, especially those concerning security export control.
- Each model of this product complies with the RoHS Directive (Restriction of the use of hazardous substances in electrical and electronic equipment) (2011/65/EU and (EU) 2015/863). The date of compliance with the RoHS Directive and REACH Regulation varies depending on the product model.  
Further, if you are using product models in stock and are not sure whether or not they comply with the RoHS Directive or REACH Regulation, please contact us by selecting "Sales Inquiry" from the inquiry form.
- During the manufacturing process of this product and any of its components and materials to be used, Panasonic does not intentionally use ozone-depleting substances stipulated in the Montreal Protocol and specific bromine-based flame retardants such as PBBs (Poly-Brominated Biphenyls) / PBDEs (Poly-Brominated Diphenyl Ethers). In addition, the materials used in this product are all listed as existing chemical substances based on the Act on the Regulation of Manufacture and Evaluation of Chemical Substances.
- With regard to the disposal of this product, please confirm the disposal method in each country and region where it is incorporated into your company's product and used.
- The technical information contained in this catalog is intended to show only typical operation and application circuit examples of this product. This catalog does not guarantee that such information does not infringe upon the intellectual property rights of Panasonic or any third party, nor imply that the license of such rights has been granted.

**Panasonic Industry will assume no liability whatsoever if the use of our company's products deviates from the contents of this catalog or does not comply with the precautions. Please be advised of these restrictions.**

## Matters to Be Observed When Using This Product

(Film capacitor : Automotive/Industrial)

### Response to anomalies and handling conditions

- Because the capacitor described herein is made of a combustible material, it may generate smoke or even ignite when exposed to excessive heat. We therefore recommend you cover the capacitor with a fire-resistant material or fire-resistant case.
- When a different component in the same circuit has short-circuited or developed an open failure, see to it that a voltage or current higher than the rated voltage or current or excessive heat is not applied to the capacitor.

### Reliability

A capacitor conforming to "AEC-Q200" refers to a capacitor having passed some or all of evaluation test items defined in AEC-Q200.

To know the detailed specifications of each capacitor or specific evaluation test scores, please contact us.

We issue a delivery specification sheet for each product ordered. Please confirm the delivery specification sheet when you place an order with us.

## Reference information

### Guidelines

Before using the capacitor, make sure to acquire our delivery specification sheet and confirm service conditions.

If you find measurement values exceeding specified values in the specification sheet or have any question, feel free to contact us. We also advise you to refer to RCR-1001B "Safety Application Guide on Components for Use in Electronic and Electrical Equipment" and JEITA RCR-2350D "Safety Application Guide for Fixed Plastic Film Capacitors for Use in Electronic Equipment."

### Intellectual property

Panasonic Group provides customers with safe products and services. We are also making great efforts to protect our intellectual property rights for Panasonic Group products. Typical patents related to this product are as follows. (Hybrid type)

[U.S. patent]

USP Nos. 7027286, 8315031, 8861177, 9240279, 10475585

[Japanese patent]

Japanese Patent No. 4784464, 4930099, 4946618, 5391797