

**GenX3™ 600V IGBT**
**IXGH56N60A3**

$$V_{CES} = 600V$$

$$I_{C110} = 56A$$

$$V_{CE(sat)} \leq 1.35V$$

Ultra-Low  $V_{sat}$  PT IGBT for up to 5 kHz Switching

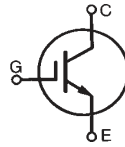

Symbol	Test Conditions	Maximum Ratings	
$V_{CES}$	$T_C = 25^\circ C$ to $150^\circ C$	600	V
$V_{CGR}$	$T_J = 25^\circ C$ to $150^\circ C$ , $R_{GE} = 1M\Omega$	600	V
$V_{GES}$	Continuous	$\pm 20$	V
$V_{GEM}$	Transient	$\pm 30$	V
$I_{C25}$	$T_C = 25^\circ C$ (Chip Capability)	150	A
$I_{C110}$	$T_C = 110^\circ C$	56	A
$I_{CM}$	$T_C = 25^\circ C$ , 1ms	370	A
<b>SSOA (RBSOA)</b>	$V_{GE} = 15V$ , $T_{VJ} = 125^\circ C$ , $R_G = 5\Omega$ Clamped Inductive Load	$I_{CM} = 150$ $V_{CE} \leq 0.8 \cdot V_{CES}$	A
$P_d$	$T_C = 25^\circ C$	330	W
$T_J$		- 55 ... +150	$^\circ C$
$T_{JM}$		150	$^\circ C$
$T_{stg}$		- 40 ... +150	$^\circ C$
$T_L$	1.6mm (0.062 in.) from Case for 10s	300	$^\circ C$
$T_{SOLD}$	Plastic Body for 10 seconds	260	$^\circ C$
$M_d$	Mounting torque	1.13/10	Nm/lb.in.
<b>Weight</b>		6	g

TO-247

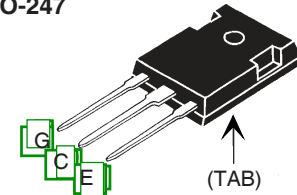

G = Gate      C = Collector  
E = Emitter    TAB = Collector

**Features**

- Optimized for Low Conduction Losses
- International Standard Package

**Advantages**

- High Power Density
- Low Gate Drive Requirement

**Applications**

- Power Inverters
- UPS
- Motor Drives
- SMPS
- PFC Circuits
- Battery Chargers
- Welding Machines
- Lamp Ballasts
- Inrush Current Protection Circuits

Symbol	Test Conditions ( $T_J = 25^\circ C$ , Unless Otherwise Specified)	Characteristic Values		
		Min.	Typ.	Max.
$BV_{CES}$	$I_C = 250\mu A$ , $V_{CE} = 0V$	600		V
$V_{GE(th)}$	$I_C = 250\mu A$ , $V_{CE} = V_{GE}$	3.0		5.0 V
$I_{CES}$	$V_{CE} = V_{CES}$ , $V_{GE} = 0V$ $T_J = 125^\circ C$			50 $\mu A$ 500 $\mu A$
$I_{GES}$	$V_{CE} = 0V$ , $V_{GE} = \pm 20V$			$\pm 100$ nA
$V_{CE(sat)}$	$I_C = 44A$ , $V_{GE} = 15V$ , Note 1 $T_J = 125^\circ C$		1.22 1.22	1.35 V V

### Symbol Test Conditions

( $T_J = 25^\circ\text{C}$  unless otherwise specified)

### Characteristic Values

Symbol	Test Conditions	Characteristic Values		
		Min.	Typ.	Max.
$g_{fs}$	$I_C = 44\text{A}, V_{CE} = 10\text{V}$ , Note 1	33	55	S
$C_{ies}$	$V_{CE} = 25\text{V}, V_{GE} = 0\text{V}, f = 1\text{MHz}$		3950	pF
$C_{oes}$			220	pF
$C_{res}$			56	pF
$Q_g$	$I_C = 44\text{A}, V_{GE} = 15\text{V}, V_{CE} = 0.5 \cdot V_{CES}$		140	nC
$Q_{ge}$			26	nC
$Q_{gc}$			52	nC
$t_{d(on)}$	<b>Inductive load, <math>T_J = 25^\circ\text{C}</math></b> $I_C = 44\text{A}, V_{GE} = 15\text{V}$ $V_{CE} = 480\text{V}, R_G = 5\Omega$ Note 2		26	ns
$t_{ri}$			42	ns
$E_{on}$			1.00	mJ
$t_{d(off)}$			310	ns
$t_{fi}$			315	550 ns
$E_{off}$			3.75	6.50 mJ
$t_{d(on)}$	<b>Inductive load, <math>T_J = 125^\circ\text{C}</math></b> $I_C = 44\text{A}, V_{GE} = 15\text{V}$ $V_{CE} = 480\text{V}, R_G = 5\Omega$ Note 2		24	ns
$t_{ri}$			42	ns
$E_{on}$			2.00	mJ
$t_{d(off)}$			495	ns
$t_{fi}$			415	ns
$E_{off}$			6.75	mJ
$R_{thJC}$			0.375	$^\circ\text{C}/\text{W}$
$R_{thCS}$		0.21		$^\circ\text{C}/\text{W}$

### TO-247 (IXGH) Outline

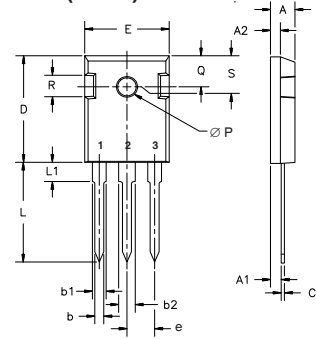

Terminals: 1 - Gate      2 - Drain  
3 - Source      Tab - Drain

Dim.	Millimeter		Inches	
	Min.	Max.	Min.	Max.
A	4.7	5.3	.185	.209
A <sub>1</sub>	2.2	2.54	.087	.102
A <sub>2</sub>	2.2	2.6	.059	.098
b	1.0	1.4	.040	.055
b <sub>1</sub>	1.65	2.13	.065	.084
b <sub>2</sub>	2.87	3.12	.113	.123
C	.4	.8	.016	.031
D	20.80	21.46	.819	.845
E	15.75	16.26	.610	.640
e	5.20	5.72	0.205	0.225
L	19.81	20.32	.780	.800
L1		4.50		.177
ØP	3.55	3.65	.140	.144
Q	5.89	6.40	0.232	0.252
R	4.32	5.49	.170	.216
S	6.15	BSC	242	BSC

### Notes:

1. Pulse test,  $t \leq 300\mu\text{s}$ , duty cycle,  $d \leq 2\%$ .
2. Switching times & energy losses may increase for higher  $V_{CE}$  (clamp),  $T_J$  or  $R_G$ .

### ADVANCE TECHNICAL INFORMATION

The product presented herein is under development. The Technical Specifications offered are derived from a subjective evaluation of the design, based upon prior knowledge and experience, and constitute a "considered reflection" of the anticipated result. IXYS reserves the right to change limits, test conditions, and dimensions without notice.

IXYS Reserves the Right to Change Limits, Test Conditions and Dimensions.

IXYS MOSFETs and IGBTs are covered by one or more of the following U.S. patents:	4,835,592	4,931,844	5,049,961	5,237,481	6,162,665	6,404,065 B1	6,683,344	6,727,585	7,005,734 B2	7,157,338B2
	4,850,072	5,017,508	5,063,307	5,381,025	6,259,123 B1	6,534,343	6,710,405 B2	6,759,692	7,063,975 B2	
	4,881,106	5,034,796	5,187,117	5,486,715	6,306,728 B1	6,583,505	6,710,463	6,771,478 B2	7,071,537	

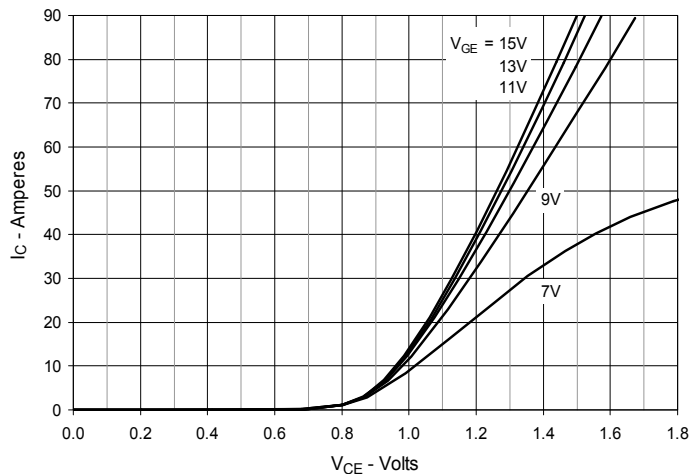
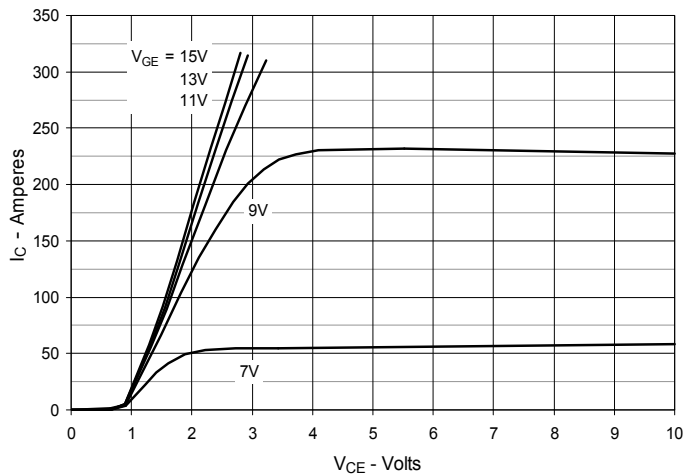
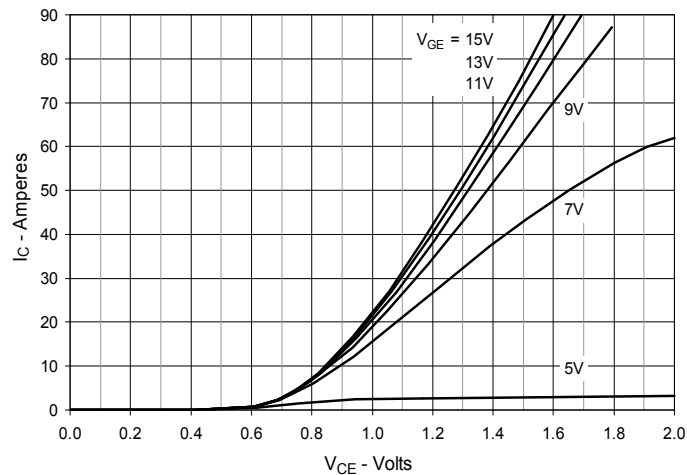
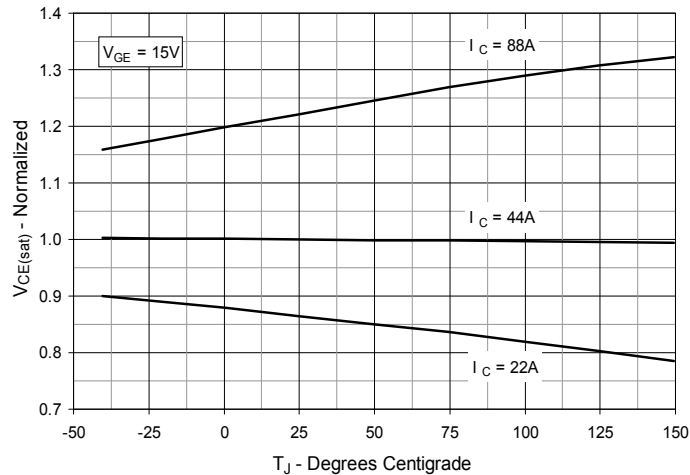
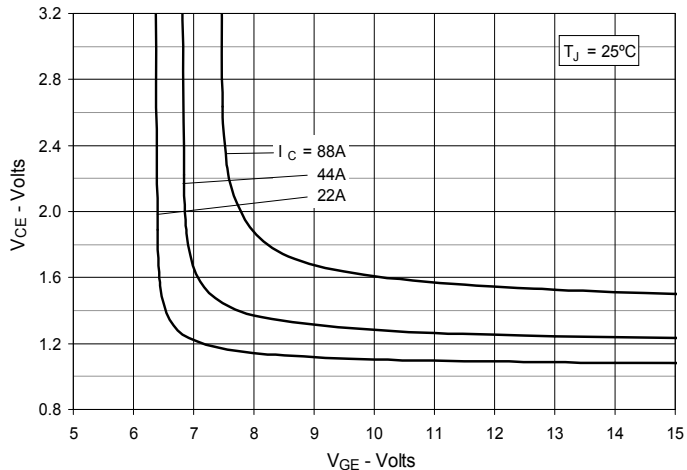
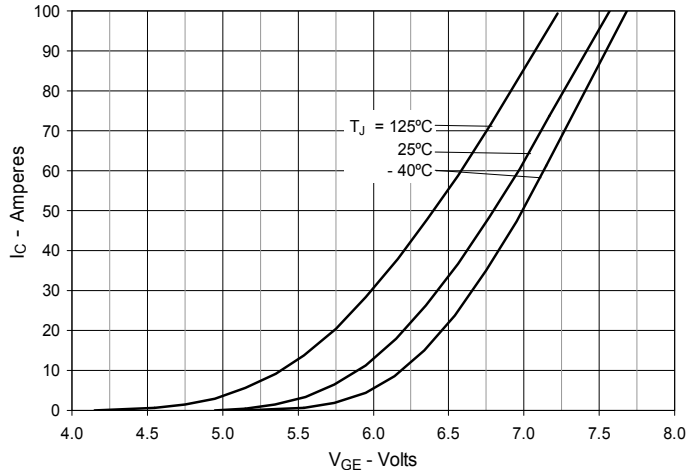
**Fig. 1. Output Characteristics**  
 @  $T_J = 25^\circ\text{C}$ 

**Fig. 2. Extended Output Characteristics**  
 @  $T_J = 25^\circ\text{C}$ 

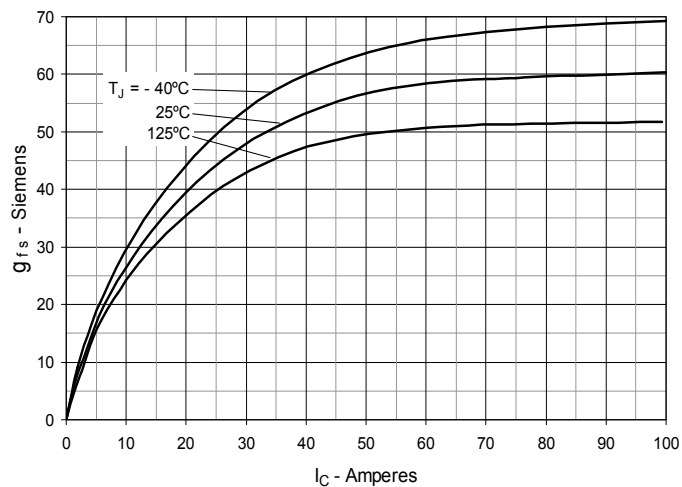
**Fig. 3. Output Characteristics**  
 @  $T_J = 125^\circ\text{C}$ 

**Fig. 4. Dependence of  $V_{CE(sat)}$  on Junction Temperature**

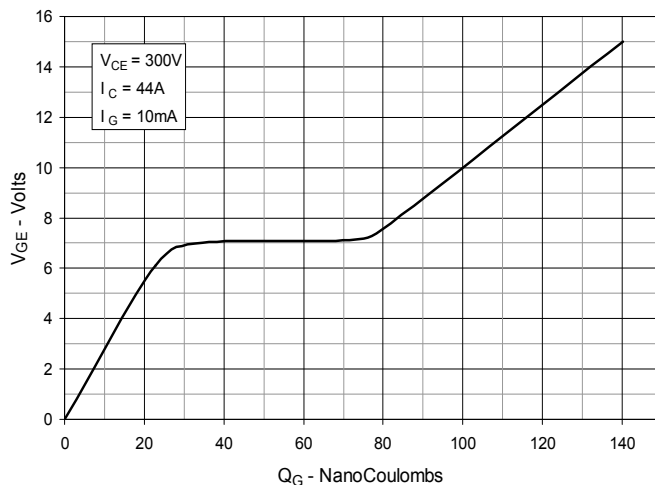
**Fig. 5. Collector-to-Emitter Voltage vs. Gate-to-Emitter Voltage**

**Fig. 6. Input Admittance**

**Fig. 7. Transconductance**



**Fig. 8. Gate Charge**



**Fig. 9. Capacitance**

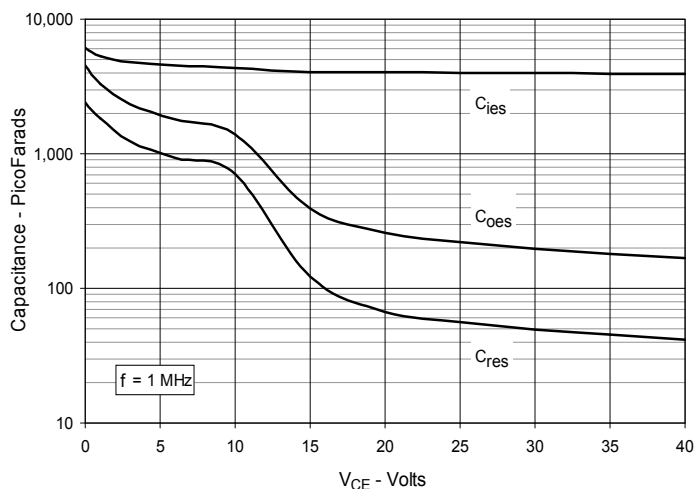

**Fig. 10. Reverse-Bias Safe Operating Area**

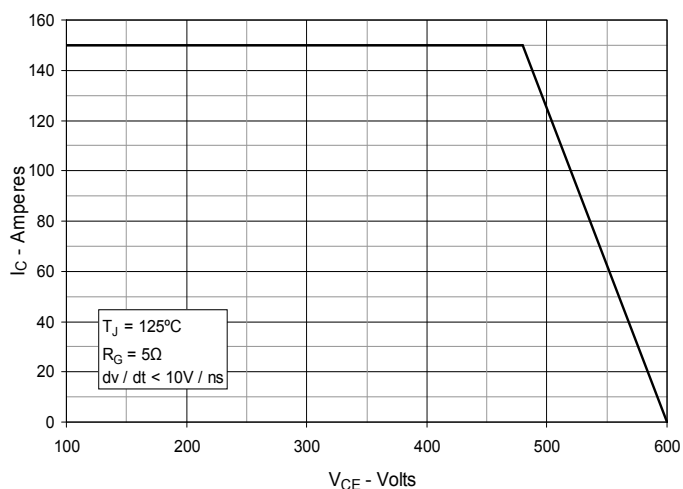

**Fig. 11. Maximum Transient Thermal Impedance**

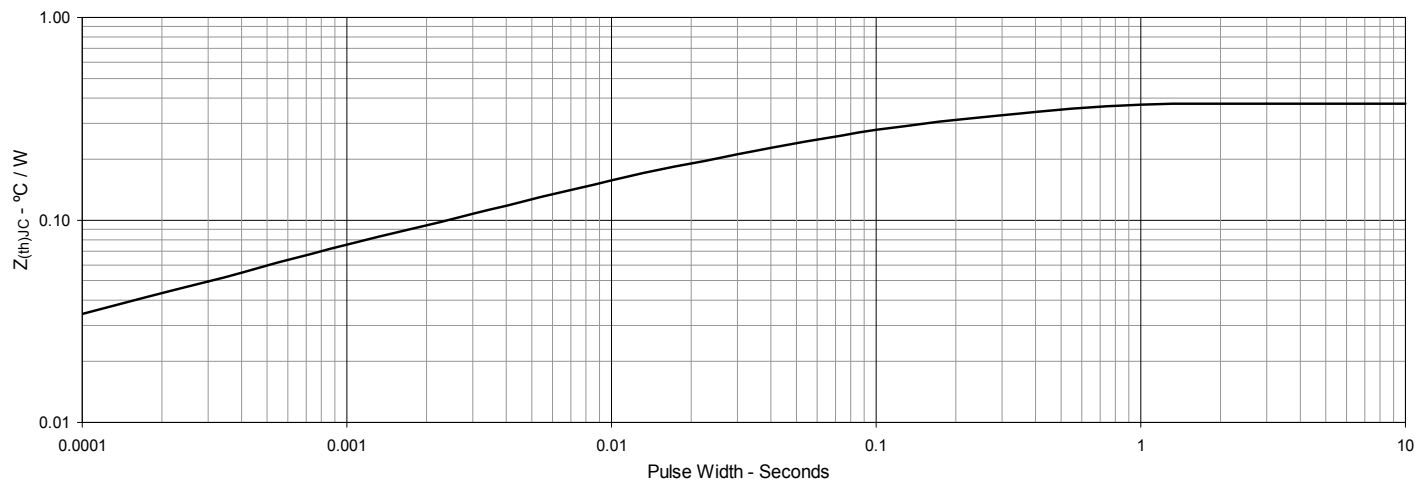

IXYS Reserves the Right to Change Limits, Test Conditions and Dimensions.

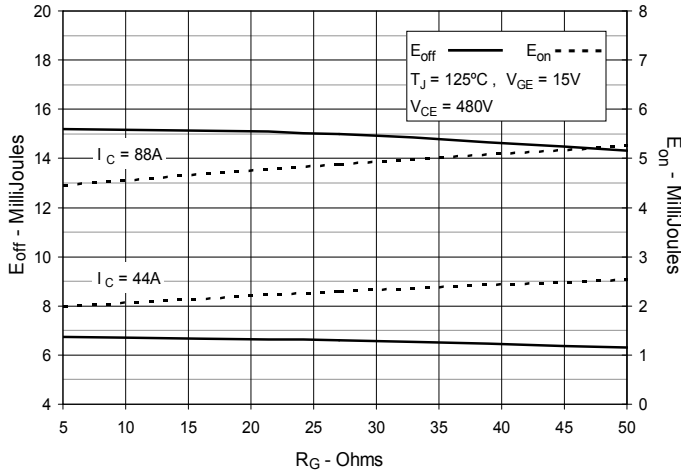
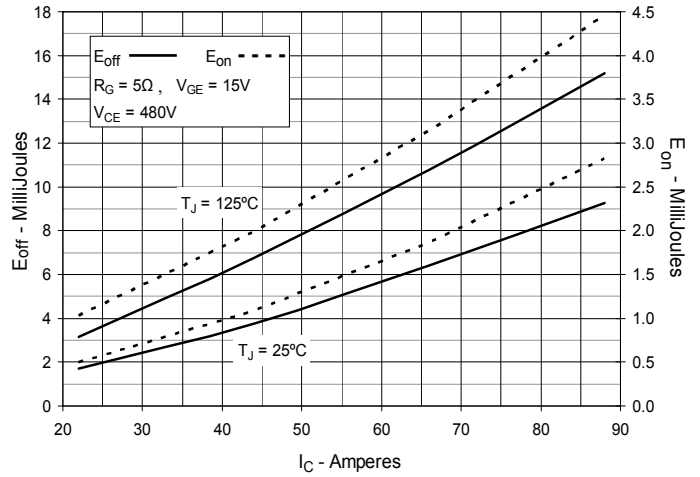
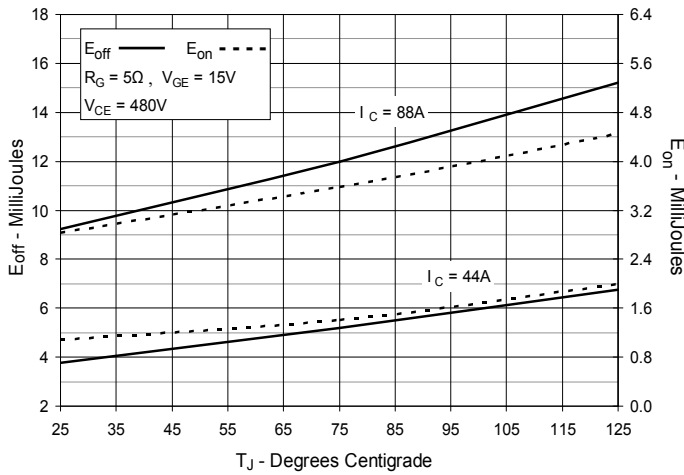
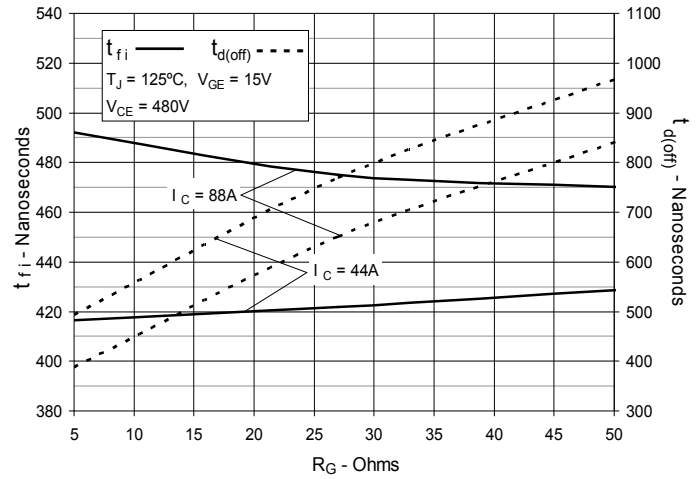
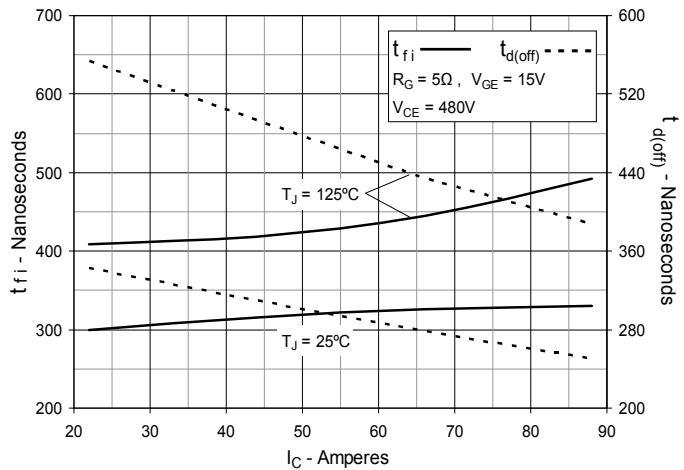
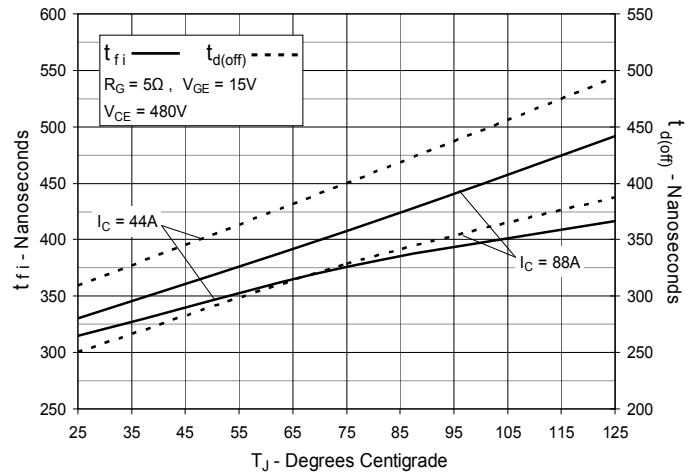
**Fig. 12. Inductive Switching  
Energy Loss vs. Gate Resistance**

**Fig. 13. Inductive Switching  
Energy Loss vs. Collector Current**

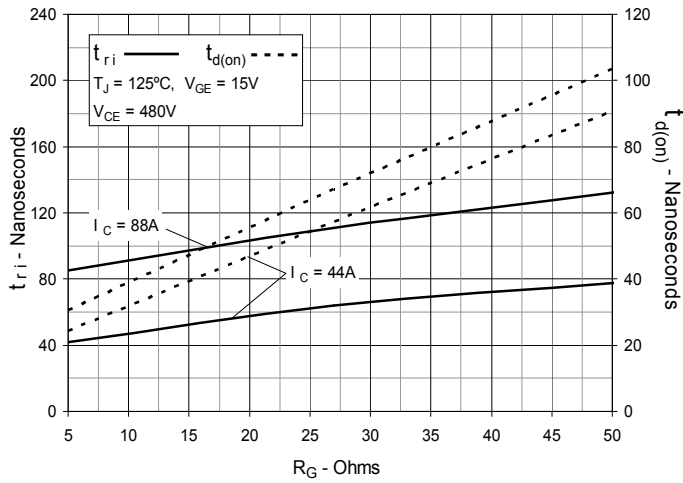
**Fig. 14. Inductive Switching  
Energy Loss vs. Junction Temperature**

**Fig. 15. Inductive Turn-off  
Switching Times vs. Gate Resistance**

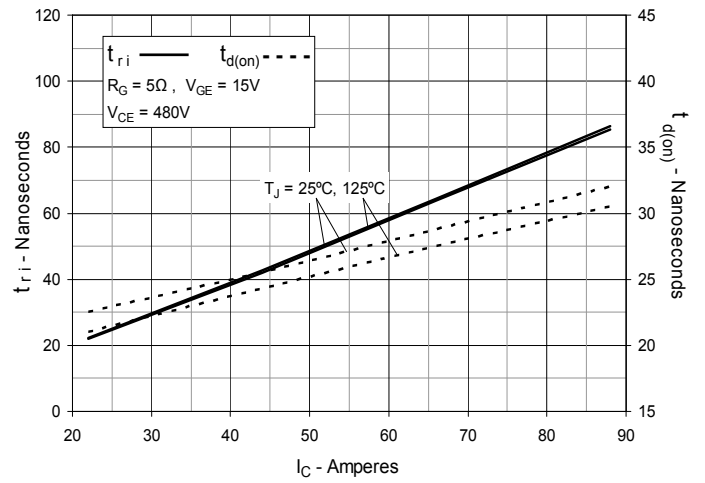
**Fig. 16. Inductive Turn-off  
Switching Times vs. Collector Current**

**Fig. 17. Inductive Turn-off  
Switching Times vs. Junction Temperature**

**Fig. 18. Inductive Turn-on  
Switching Times vs. Gate Resistance**



**Fig. 19. Inductive Turn-on  
Switching Times vs. Collector Current**



**Fig. 20. Inductive Turn-on  
Switching Times vs. Junction Temperature**

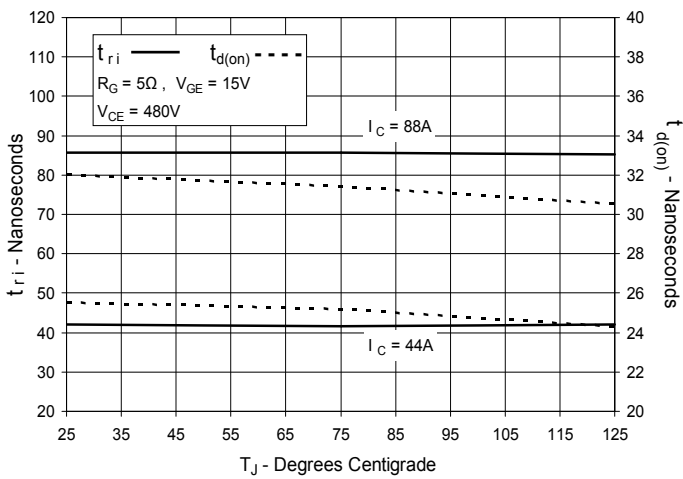



---

Disclaimer Notice - Information furnished is believed to be accurate and reliable. However, users should independently evaluate the suitability of and test each product selected for their own applications. Littelfuse products are not designed for, and may not be used in, all applications. Read complete Disclaimer Notice at [www.littelfuse.com/disclaimer-electronics](http://www.littelfuse.com/disclaimer-electronics).