

XCVR-080W37-120-NT-C

Ciena® XCVR-080W37-120 Compatible TAA 1000Base-DWDM 100GHz SFP Transceiver (SMF, 1547.72nm, 120km, LC, DOM)

Features:

- INF-8074 and SFF-8472 Compliance
- Duplex LC Connector
- Commercial Temperature 0 to 70 Celsius
- Single-mode Fiber
- Hot Pluggable
- Excellent ESD Protection
- Metal with Lower EMI
- RoHS Compliant and Lead Free



Applications:

- Gigabit Ethernet over DWDM
- 1x Fibre Channel
- Access, Metro and Enterprise

Product Description

This Ciena® XCVR-080W37-120 compatible SFP transceiver provides 1000Base-DWDM throughput up to 120km over single-mode fiber (SMF) using a wavelength of 1547.72nm via an LC connector. It is guaranteed to be 100% compatible with the equivalent Ciena® transceiver. This easy to install, hot swappable transceiver has been programmed, uniquely serialized and data-traffic and application tested to ensure that it will initialize and perform identically. Digital optical monitoring (DOM) support is also present to allow access to real-time operating parameters. This transceiver is Trade Agreements Act (TAA) compliant. We stand behind the quality of our products and proudly offer a limited lifetime warranty.

ProLabs's transceivers are RoHS compliant and lead-free.

TAA refers to the Trade Agreements Act (19 U.S.C. & 2501-2581), which is intended to foster fair and open international trade. TAA requires that the U.S. Government may acquire only "U.S. – made or designated country end products."



Regulatory Compliance

- ESD to the Electrical PINs: compatible with MIL-STD-883E Method 3015.4
- ESD to the LC Receptacle: compatible with IEC 61000-4-3
- EMI/EMC compatible with FCC Part 15 Subpart B Rules, EN55022:2010
- Laser Eye Safety compatible with FDA 21CFR, EN60950-1& EN (IEC) 60825-1,2
- RoHS compliant with EU RoHS 2.0 directive 2015/863/EU

Absolute Maximum Ratings

Parameter	Symbol	Min.	Typ.	Max.	Unit	Notes
Maximum Supply Voltage	Vcc	0		3.6	V	
Storage Temperature	TS	-40		+85	°C	
Operating Case Temperature	Tc	0		+70	°C	
Relative Humidity	RH	5		85	%	1
Electrical static discharge (HBM Model)	ESD	500		1000	V	2
Receiver Optical Damage Threshold	RXDmg			+3.5	dBm	3

Notes:

1. Non-condensing
2. ESD, per JEDEC JESD22-A114-B
3. This must not be exceeded

Electrical Characteristics

Parameter	Symbol	Min.	Typ.	Max.	Unit	Notes
Power Supply Voltage	Vcc	3.14	3.3	3.46	V	
Power supply current	Icc			550	mA	
Total power dissipation	PD			1.8	W	

Optical Characteristics

Parameter	Symbol	Min.	Typ.	Max.	Unit
Transmitter					
Signaling Rate				1.25	Gbps
Optical Output Power	P _o	-1		+5	dBm
Transmission Distance		0		120	km
Transmitter Dispersion Penalty	TDP			2	dB
Extinction Ratio	ER	8.2			dB
Optical Eye Shape & Mask		IEEE 802.3ab			
Eye Mask Margin		10			%
Spectral Width				1	nm
Optical Frequency Tuning Range (5 bands)		192.00 (1561.42)		195.90 (1530.33)	THz (nm)
SMSR		30	35		dB
Optical Frequency Minimum Tuning Grid		100			GHz
Optical Centre Wavelength	λ_c	As per ITU-T 694.1			nm
Optical Frequency Accuracy (deviation from centre)		-12.5		+12.5	GHz
Time to Initialize Cooled Operation			10	90	Sec
Tuning Speed (Channel to Channel)				10	Sec
Receiver					
Receiver Wavelength Range		191.00 (1569.59)		197.00 (1521.79)	THz (nm)
Receiver Overload		-12			dBm
Receiver Sensitivity (BER 1E-12, PRBS 231-1)				-30	dBm
Receiver Optical Reflectance				-27	dB
LOS assert		-35		-30	dBm
LOS assert/de-assert hysteresis		0.5		2.0	dB

Block Diagram



Pin Descriptions

Pin	Logic	Symbol	Name/Descriptions	Notes
1		VeeT	Module Transmitter Ground	1
2	LVTTTL-O	TX Fault	Module Transmitter Fault	2
3	LVTTTL-I	TX Disable	Transmitter Disable. Turns off laser output	3
4	LVTTTL-I/O	SDA	2-wire Serial interface Data line	
5	LVTTTL-I/O	SCL	2-wire Serial Interface Clock	
6		Mod ABS	Module absent, connect to VeeT or VeeR in the module	
7	LVTTTL-I	RS0	Unused	
8	LVTTTL-O	Rx LOS	Receiver Loss of Signal Indication	2
9	LVTTTL-I	RSI	Unused	
10		VeeR	Module Receiver Ground	1
11		VeeR	Module Receiver Ground	1
12	CML-O	RD-	Receiver Inverted Data Output	
13	CML-O	RD+	Receiver Non-Inverted Data Output	1
14		VeeR	Module Receiver Ground	
15		VccR	Module Receiver 3.3V Supply	
16		VccT	Module Transmitter 3.3V Supply	
17		VeeT	Module Transmitter Ground	1
18	CML-I	TD+	Transmitter Non-Inverted Data Input	
19	CML-I	TD-	Transmitter Inverted Data Input	
20		VeeT	Module Transmitter Ground	1

Notes:

1. The module signal ground pins, VeeR and VeeT, are isolated from the module chassis ground.

2. This pin is an open collector/drain output pin and shall be pulled up with 4.7-10 kohms to power supply voltage between 3.3V and 3.5V on the host board.
3. TX_Disable is an input contact with a 4.7-10 kohm pull-up to VccT inside the module.

Electrical Pin-out Details

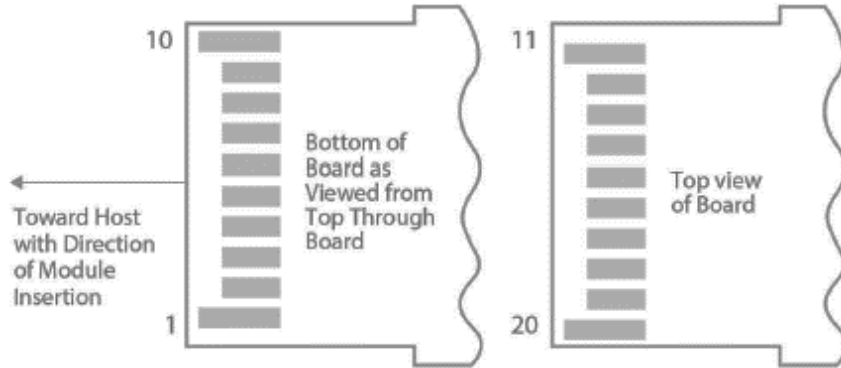

Mechanical Specifications

Small Form Factor Pluggable (SFP) transceivers are compatible with the dimensions defined by the SFP Multi-Sourcing Agreement (MSA).

W 13.9mm x L 56.5mm x H 11.85mm

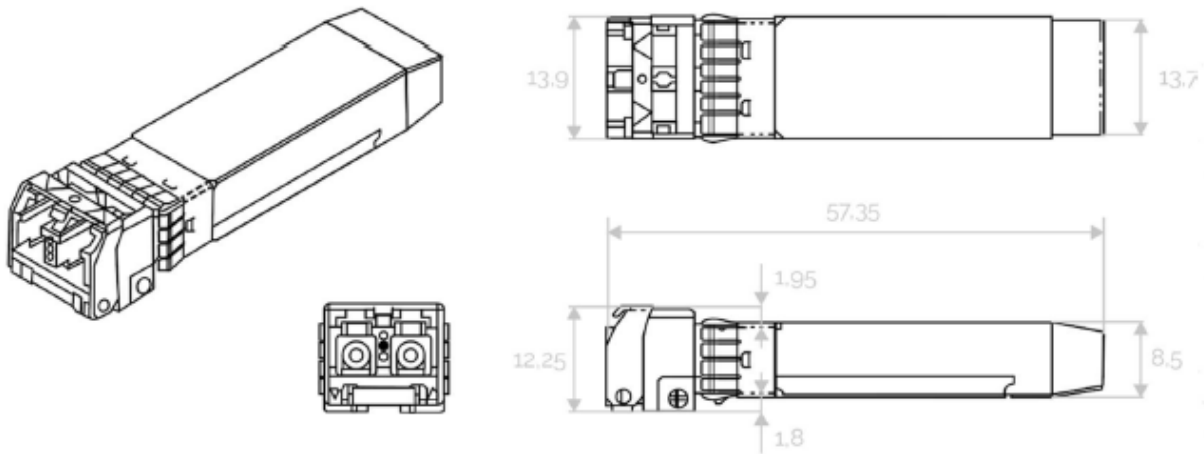

About ProLabs

Our experience comes as standard; for over 15 years ProLabs has delivered optical connectivity solutions that give our customers freedom and choice through our ability to provide seamless interoperability. At the heart of our company is the ability to provide state-of-the-art optical transport and connectivity solutions that are compatible with over 90 optical switching and transport platforms.

Complete Portfolio of Network Solutions

ProLabs is focused on innovations in optical transport and connectivity. The combination of our knowledge of optics and networking equipment enables ProLabs to be your single source for optical transport and connectivity solutions from 100Mb to 400G while providing innovative solutions that increase network efficiency. We provide the optical connectivity expertise that is compatible with and enhances your switching and transport equipment.

Trusted Partner

Customer service is our number one value. ProLabs has invested in people, labs and manufacturing capacity to ensure that you get immediate answers to your questions and compatible product when needed. With Engineering and Manufacturing offices in the U.K. and U.S. augmented by field offices throughout the U.S., U.K. and Asia, ProLabs is able to be our customers best advocate 24 hours a day.

Contact Information

ProLabs US

Email: sales@prolabs.com

Telephone: 952-852-0252

ProLabs UK

Email: salessupport@prolabs.com

Telephone: +44 1285 719 600