

REVISIONS					
REV	ECO	DESCRIPTION	DATE	BY	APPR
A1	-	RELEASE DRAWING	25MAY18	RIMON	TOMMY
A2	-	UPDATE NOTES	19FEB19	SULLEN	TOMMY

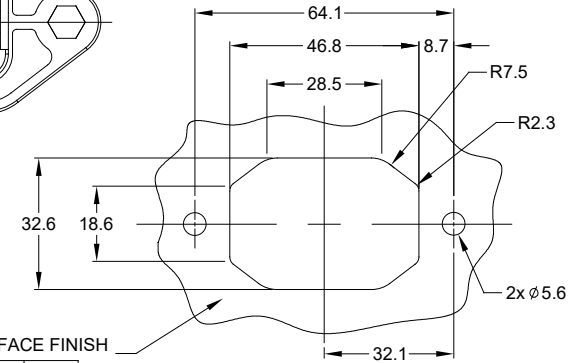
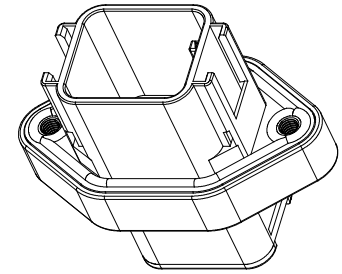
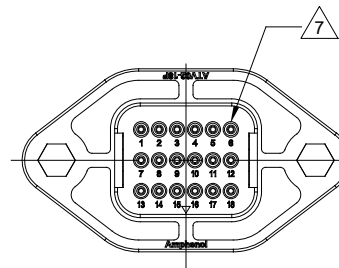
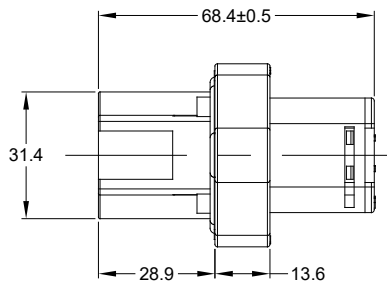
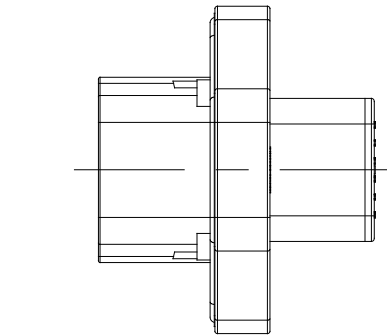
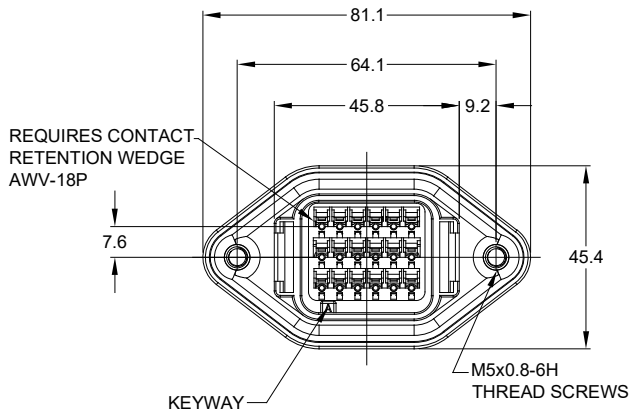

INTERNAL SEALING SURFACE FINISH TO BE $\sqrt{32}$ OR BETTER \square 0.13

RECOMMENDED PANEL CUTOUT

NOTES: UNLESS OTHERWISE SPECIFIED

RECOMMENDED TORQUE VALUES: 1.5-2.0 N.m

- SEE SHEET 2 FOR KEY ARRANGEMENTS AND COLORS.
- MATERIAL:
HOUSING: THERMOPLASTIC
SEAL: SILICONE RUBBER, COLOR: RED
- MODIFICATIONS: FLANGE MOUNT
STANDARD DIAMETER WIRE SEAL
- SPECIFICATIONS:
4.1 CURRENT RATING: 13 AMPS
4.2 OPERATING TEMPERATURE: -55°C TO +125°C.
4.3 DIELECTRIC WITHSTANDING VOLTAGE: LESS THAN 2 MILLIAMPS CURRENT LEAKAGE @ 1500 VOLTS AC.
4.4 INSULATION RESISTANCE: 1000 MEGOHMS MIN @ 25°C.
A2 4.5 MOISTURE RESISTANCE: IP67&IP69K (MATED CONDITION)
4.6 MATING CYCLE DURABILITY: 100 CYCLES
4.7 RoHS COMPLIANT
- MATING PART: ATV06-18SX* PLUG
(X = A,B,C,D KEYS ; * = MODIFICATIONS AND COLORS)
- ALL DIMENSIONS ARE FOR REFERENCE USE ONLY.

CONTACT SIZE AND REAR SEAL WIRE RANGE:

CONTACT SIZE	MIN. INSUL O.D.	MAX. INSUL O.D.	TYPICAL WIRE RANGE
16	2.23 mm (.088 in)	3.68 mm (.145 in)	14 - 20 AWG

SEE SHEET 2		REF: DTV02-18PA, DTV02-18PB, DTV02-18PC, DTV02-18PD	
PART NUMBER		DESCRIPTION	
QUANTITY		ITEM	
MATERIALS LIST			
UNLESS OTHERWISE SPECIFIED		SIGNATURES	
1) All dimensions are in metric (mm). 2) Tolerances are as follows: 1 PL DEC ±0.30 Fractions ±1/64 2 PL DEC ±0.15 3 PL DEC ±0.08 3) Note reference = \triangle X		DATE	
DRAWN: SULLEN,ZHANG		19FEB19	
CHECKED: ORION,LJ		19FEB19	
ENGINEER:		APPROVAL: TOMMY,XIE	
MATERIAL SPECIFICATIONS:		19FEB19	
PROCESS SPECIFICATIONS:		CUSTOMER:	
NEXT ASSY:		THIS DRAWING IS SUPPLIED FOR INFORMATION ONLY. DESIGN FEATURES, SPECIFICATIONS AND PERFORMANCE DATA SHOWN HEREON ARE THE PROPERTY OF THE AMPHENOL CORPORATION. NO RIGHTS OF REPRODUCTION ARE IMPLIED. ALL DIMENSIONS ARE SUBJECT TO NORMAL MANUFACTURING VARIATIONS.	
SIZE		TYPE	
B C-		ATV02-18PX	
SCALE: NONE		REVISION	
SHEET 1 OF 2		A2	

TITLE: RECEPTACLE FLANGE (8PIN) ATV SERIES STANDARD DIA. WIRE SEAL
DWG NO: ATV02-18PX
REV: A2
SH: 1
OF: 2

REVISIONS					
REV	ECO	DESCRIPTION	DATE	BY	APPR
A1	-	RELEASE DRAWING	25MAY18	SULLEN	TOMMY
A2	-	UPDATE NOTES	19FEB19	SULLEN	TOMMY

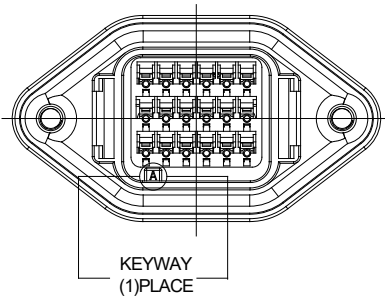

KEY-A CONFIGURATION	
COLOR	PART NUMBER
GREY	ATV02-18PA

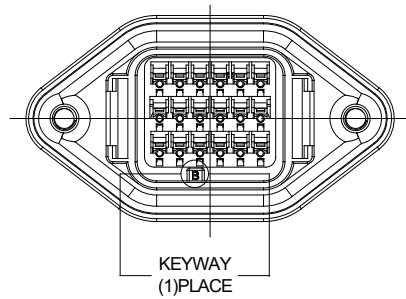

KEY-B CONFIGURATION	
COLOR	PART NUMBER
BLACK	ATV02-18PB

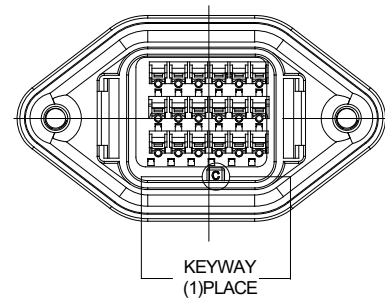

KEY-C CONFIGURATION	
COLOR	PART NUMBER
GREEN	ATV02-18PC

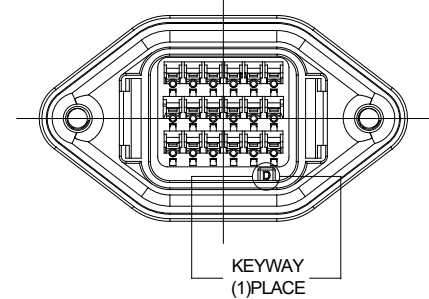



KEY-D CONFIGURATION	
COLOR	PART NUMBER
BROWN	ATV02-18PD



SEE CONFIGURATION CHART				
PART NUMBER		DESCRIPTION		ITEM
QUANTITY	MATERIALS LIST			
UNLESS OTHERWISE SPECIFIED: 1) All dimensions are in metric(mm). 2) Tolerances are as follows: 1 PL DEC ±0.30 2 PL DEC ±0.15 3 PL DEC ±0.08 3) Note reference =		SIGNATURES		DATE
		DRAWN: SULLEN,ZHANG		19FEB19
		CHECKED: ORION,LI		19FEB19
		APPROVAL: TOMMY,XIE		19FEB19
MATERIAL SPECIFICATIONS:		CUSTOMER:		
PROCESS SPECIFICATIONS:		THIS DRAWING IS SUPPLIED FOR INFORMATION ONLY. DESIGN FEATURES, SPECIFICATIONS AND PERFORMANCE DATA SHOWN HEREON ARE THE PROPERTY OF THE AMPHENOL CORPORATION. NO RIGHTS OF REPRODUCTION ARE IMPLIED. ALL DIMENSIONS ARE SUBJECT TO NORMAL MANUFACTURING VARIATIONS.		
NEXT ASSY:		SCALE: NONE		
		 Sine Systems - www.amphenol-sine.com 44724 Morley Drive Clinton Township, MI 48036		REVISION
		RECEPTACLE, FLANGE, 18 PIN, ATV SERIES STANDARD DIA. WIRE SEAL		
SIZE	TYPE	DWG NO.	REVISION	
B	C-	ATV02-18PX	A2	
SHEET 2		OF 2		

TITLE: RECEPTACLE, FLANGE, 18 PIN, ATV SERIES STANDARD DIA. WIRE SEAL
 DWG NO: ATV02-18PX
 REV: A2
 SH: 2
 OF: 2



AT Series™ - Contact Size 16 Options

Machined Contacts, Sockets & Pins				
Part Number	Description	Size	AWG	Type
AT60-215-1631	Male Contact - Pin, Gold-plated	16	14	Machined
AT62-209-1631	Female Contact - Socket, Gold-plated	16	14	Machined
AT60-215-16141	Male Contact - Pin, Nickel-plated	16	14	Machined
AT62-209-16141	Female Contact - Socket, Nickel-plated	16	14	Machined
AT60-202-1631	Male Contact - Pin, Gold-plated	16	16-20	Machined
AT62-201-1631	Female Contact - Socket, Gold-plated	16	16-20	Machined
AT60-202-16141	Male Contact - Pin, Nickel-plated	16	16-20	Machined
AT62-201-16141	Female Contact - Socket, Nickel-plated	16	16-20	Machined
AT60-202-1631-22	Male Contact - Pin, Gold-plated	16	22-24	Machined
AT62-201-1631-22	Female Contact - Socket, Gold-plated	16	22-24	Machined
AT60-202-16141-22	Male Contact - Pin, Nickel-plated	16	22-24	Machined
AT62-201-16141-22	Female Contact - Socket, Nickel-plated	16	22-24	Machined

Tooling - Machined Contacts		
Part	Part Number	Description
	CA-5D12	Universal Hand Crimp Tool, Size 12/16/20 (Machined contacts only)
	CA-5E12	Pneumatic Crimp Tool, Size 12/16/20 (Machined contacts only)

Contact Removal Tools		
Part	Part Number	Description
	ATRT-100	Used for removal of contacts for A Series™ products
	AT11-310-1605	Contact Removal Tool, Plastic, Size 16
	A114017	Sealing Plug, Size 16, White

Stamped & Formed Contacts, Sockets & Pins				
Part Number	Description	Size	AWG	Type
AT60-14-0144	Male Contact - Pin, Gold-plated	16	14-16	Stamped & Formed
AT62-14-0144	Female Contact - Socket, Gold-plated	16	14-16	Stamped & Formed
AT60-14-0122	Male Contact - Pin, Nickel-plated	16	14-16	Stamped & Formed
AT62-14-0122	Female Contact - Socket, Nickel-plated	16	14-16	Stamped & Formed
AT60-16-0144	Male Contact - Pin, Gold-plated	16	16-18	Stamped & Formed
AT62-16-0144	Female Contact - Socket, Gold-plated	16	16-18	Stamped & Formed
AT60-16-0122	Male Contact - Pin, Nickel-plated	16	16-18	Stamped & Formed
AT62-16-0122	Female Contact - Socket, Nickel-plated	16	16-18	Stamped & Formed
AT60-16-0644	Male Contact - Pin, Gold-plated	16	18-20	Stamped & Formed
AT62-16-0644	Female Contact - Socket, Gold-plated	16	18-20	Stamped & Formed
AT60-16-0622	Male Contact - Pin, Nickel-plated	16	18-20	Stamped & Formed
AT62-16-0622	Female Contact - Socket, Nickel-plated	16	18-20	Stamped & Formed
AT60-16-0844	Male Contact - Pin, Gold-plated	16	20-22	Stamped & Formed
AT62-16-0844	Female Contact - Socket, Gold-plated	16	20-22	Stamped & Formed
AT60-16-0822	Male Contact - Pin, Nickel-plated	16	20-22	Stamped & Formed
AT62-16-0822	Female Contact - Socket, Nickel-plated	16	20-22	Stamped & Formed

Tooling - Stamped & Formed Contacts		
Part	Part Number	Description
	MFX-3950	Crimp Die - Size 16, 18-20AWG (S&F contacts only)
	MFX-3953	Crimp Die - Size 16, 16-18AWG (S&F contacts only)
	MFX-3975	Crimp Die - Size 16, 14-16AWG (S&F contacts only)
	MFX-3990	Crimp Die - Size 16, 20-22AWG (S&F contacts only)
	ATT-16-00	Hand Crimp Tool - Size 16, 14-16AWG (S&F contacts only)
	ATT-16-01	Hand Crimp Tool - Size 16, 18-20AWG (S&F contacts only)
	ATT-1612-03	Hand Crimp Tool - Size 16, 20-22AWG (S&F contacts only)

Amphenol Sine Systems
 44724 Morley Drive
 Clinton Township, MI 48036 USA
www.amphenol-sine.com
 09/2021