



### DESCRIPTION

The MP4312 is a configurable-frequency, synchronous step-down switching converter with integrated internal high-side and low-side power MOSFETs (HS-FET and LS-FET, respectively). It provides up to 2A of highly efficient output current ( $I_{OUT}$ ) with current mode control for fast loop response.

The wide 3.3V to 45V input voltage ( $V_{IN}$ ) range accommodates a variety of step-down applications in automotive input environments. A 1.7 $\mu$ A shutdown current ( $I_{SD}$ ) allows the device to be used in battery-powered applications.

High power conversion efficiency across a wide load range is achieved by scaling down the switching frequency ( $f_{SW}$ ) under light-load conditions to reduce the switching and gate driver losses. An open-drain power good (PG) signal indicates whether the output is within 95% to 105% of its nominal voltage.

Frequency foldback helps prevent inductor current ( $I_L$ ) runaway during start-up. Thermal shutdown provides reliable, fault-tolerant operation. High-duty cycle and low-dropout mode are provided for automotive cold-crank conditions.

The MP4312 is available in a QFN-20 (4mmx4mm) package.

### FEATURES

- Wide 3.3V to 45V Operating Input Voltage ( $V_{IN}$ ) Range
- 2A Continuous Output Current ( $I_{OUT}$ )
- 1.7 $\mu$ A Low Shutdown Current ( $I_{SD}$ )
- 18 $\mu$ A Sleep Mode Quiescent Current ( $I_Q$ )
- Internal 48m $\Omega$ /20m $\Omega$  High-Side and Low-Side MOSFETs (HS-FET and LS-FET)
- 350kHz to 1000kHz Configurable Switching Frequency ( $f_{SW}$ ) for Car Battery Applications
- Can Be Synchronized to an External Clock
- Out-of-Phase Synchronized Clock Output
- Frequency Spread Spectrum (FSS) for Low EMI
- Symmetric  $V_{IN}$  for Low EMI
- Power Good (PG) Output
- External Soft Start (SS)
- 100ns Minimum On Time ( $t_{ON\_MIN}$ )
- Selectable Advanced Asynchronous Modulation (AAM) Mode or Forced Continuous Conduction Mode (FCCM)
- Low-Dropout (LDO) Mode
- Over-Current Protection (OCP) with Hiccup Mode
- Available in a QFN-20 (4mmx4mm) Package
- Available in a Wettable Flank Package

### APPLICATIONS

- Radios
- Battery-Powered Systems
- General-Purpose Consumer Applications
- Industrial Power Systems

All MPS parts are lead-free, halogen-free, and adhere to the RoHS directive. For MPS green status, please visit the MPS website under Quality Assurance. "MPS", the MPS logo, and "Simple, Easy Solutions" are trademarks of Monolithic Power Systems, Inc. or its subsidiaries.

**TYPICAL APPLICATION**

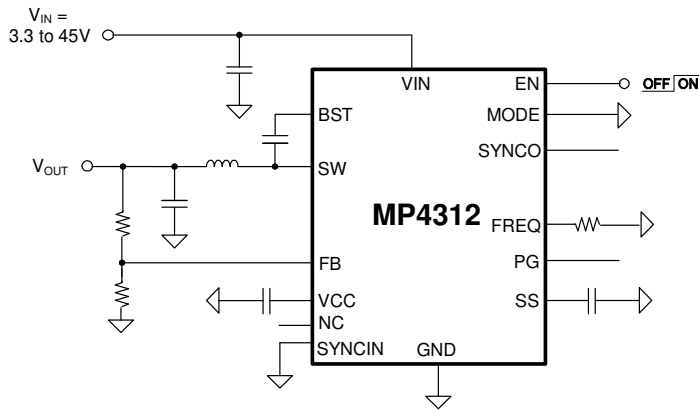

**Efficiency vs. Load Current**

V<sub>OUT</sub> = 5V, f<sub>sw</sub> = 470kHz, L = 5.6μH,  
DCR = 14.5mΩ, AAM mode

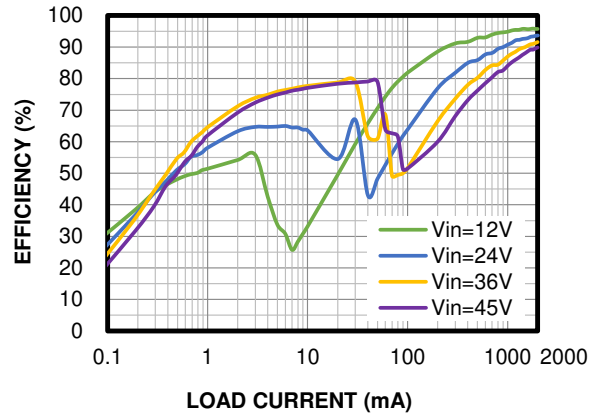

### ORDERING INFORMATION

Part Number*	Package	Top Marking	MSL Rating**
MP4312GRE***	QFN-20 (4mmx4mm)	See below	1

\* For Tape & Reel, add suffix -Z (e.g. MP4312GRE-Z).

\*\* Moisture Sensitivity Level Rating

\*\*\* Wettable flank

### TOP MARKING (MP4312GRE-Z)

**MPSYWW**

**MP4312**

**LLLLLL**

**E**

MPS: MPS prefix  
 Y: Year code  
 WW: Week code  
 MP4312: Part number  
 LLLLLL: Lot number  
 E: Wettable flank

### PACKAGE REFERENCE

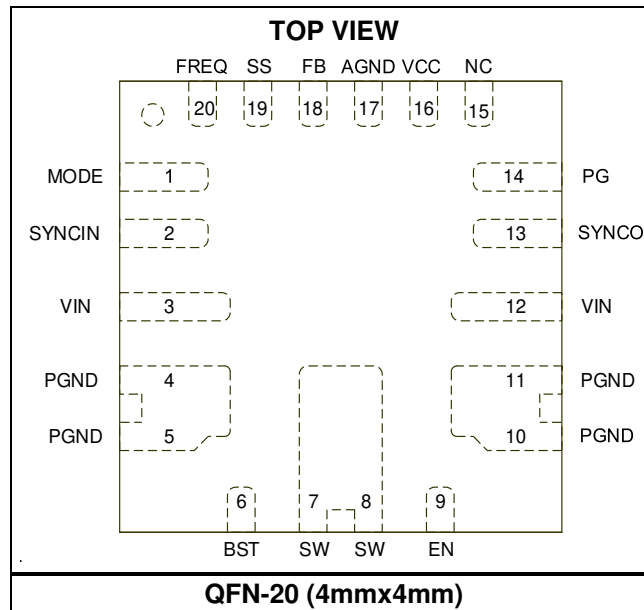

## PIN FUNCTIONS

Pin #	Name	Description
1	MODE	<b>Mode selection.</b> Pull the MODE pin high make the converter operate in forced continuous conduction mode (FCCM). Pull MODE low to make it operate in advanced asynchronous modulation (AAM) mode under light-load conditions. Do not float MODE.
2	SYNCIN	<b>Synchronous input.</b> Apply a 350kHz to 1000kHz clock signal to the SYNCIN pin to synchronize the internal oscillator frequency to the external clock. SYNCIN is also used for multiphase operation. SYNCIN has an internal high impedance (Hi-Z). Do not float this pin under any circumstances. If SYNCIN is used, ensure that the external synchronous clock has adequate pull-up and pull-down resistance. If the external clocks pull-down resistance is not sufficient, or if SYNCIN enters a Hi-Z state, place a $\leq 51\text{k}\Omega$ resistor between the SYNCIN and AGND pins. Do not float SYNCIN.
3, 12	VIN	<b>Input supply.</b> The VIN pin supplies power to the internal circuitry and the high-side MOSFET (HS-FET) connected to the SW pin. To minimize switching spikes at the input, connect a decoupling capacitor between the VIN and PGND pins. Place this capacitor close to VIN.
4, 5, 10, 11	PGND	<b>Power ground.</b>
6	BST	<b>Bootstrap.</b> The BST pin is the positive power supply for the HS-FET driver. Connect a bypass capacitor between the BST and SW pins. For more information, see the Selecting the External Bootstrap (BST) Diode and Resistor section on page 32.
7, 8	SW	<b>Switch output.</b> The SW pin is the output of the internal power MOSFETs.
9	EN	<b>Enable.</b> Pull the EN pin above 1V to turn the converter on; pull EN below 0.85V to turn it off.
13	SYNCO	<b>Synchronous output.</b> The SYNCO pin outputs a clock that is 180° out of phase with the internal oscillator. SYNCO can also output a signal opposite of the clock applied at the SYNCIN pin. Float SYNCO if not used.
14	PG	<b>Power good indicator.</b> The PG pin is an open-drain output. Connect PG to a power source via a pull-up resistor. If the output voltage ( $V_{OUT}$ ) is between 95% and 105% of the nominal voltage, then PG is pulled high. If $V_{OUT}$ exceeds 106.5% or drops below 93% of the nominal voltage, then PG is pulled low.
15	NC	<b>Not connected.</b> Float the NC pin.
16	VCC	<b>Bias supply.</b> This supplies power to the internal control circuit and gate drivers. Decoupling capacitor to ground is required close to this pin. For more information, see the Selecting the VCC Capacitor ( $C_{VCC}$ ) section on page 32.
17	AGND	<b>Analog ground.</b>
18	FB	<b>Feedback input.</b> To set $V_{OUT}$ , connect the FB pin to the center of the external resistor divider. Place the resistor divider as close to FB as possible. Keep vias away from the FB traces. The feedback voltage ( $V_{FB}$ ) threshold is 0.815V.
19	SS	<b>Soft-start input.</b> Place a capacitor between the SS and AGND pins to set the soft-start time ( $t_{SS}$ ). During start-up, SS provides 13 $\mu$ A to the soft-start capacitor ( $C_{SS}$ ). As the SS voltage ( $V_{SS}$ ) increases, $V_{FB}$ increases to limit the input inrush current during start-up.
20	FREQ	<b>Switching frequency setting.</b> Connect a resistor between the FREQ and AGND pins to set the switching frequency ( $f_{SW}$ ). For more information, see the $f_{SW}$ vs. $R_{FREQ}$ curves on page 15.

**ABSOLUTE MAXIMUM RATINGS** <sup>(1)</sup>

V <sub>IN</sub> , V <sub>EN</sub> .....	-0.3V to +50V
V <sub>SW</sub> .....	-0.3V to V <sub>IN_MAX</sub> + 0.3V
V <sub>BST</sub> .....	V <sub>SW</sub> + 5.5V
All other pins .....	-0.3V to +5.5V
Continuous power dissipation (T <sub>A</sub> = 25°C) <sup>(2) (5)</sup>	
QFN-20 (4mmx4mm) .....	5.4W
Operating junction temperature (T <sub>J</sub> ) .....	150°C
Lead temperature .....	260°C
Storage temperature .....	-65°C to +150°C

**ESD Ratings**

Human body model (HMB) .....	±2kV
Charged device model (CDM) .....	±750V

**Recommended Operating Conditions**

Input voltage (V <sub>IN</sub> ) .....	3.3V to 45V
Output voltage (V <sub>OUT</sub> ) .....	0.815V to 0.95 x V <sub>IN</sub>
Operating T <sub>J</sub> .....	-40°C to +125°C <sup>(3)</sup>

<b>Thermal Resistance</b>	<b>θ<sub>JA</sub></b>	<b>θ<sub>JC</sub></b>
QFN-20 (4mmx4mm)		
JESD51-7 <sup>(4)</sup> .....	44.....	9..... °C/W
EVQ4312-R-00A <sup>(5)</sup> .....	23.....	2.5..... °C/W

**Notes:**

- 1) Exceeding these ratings may damage the device.
- 2) The maximum allowable power dissipation is a function of the maximum junction temperature T<sub>J</sub> (MAX), the junction-to-ambient thermal resistance θ<sub>JA</sub>, and the ambient temperature T<sub>A</sub>. The maximum allowable continuous power dissipation at any ambient temperature is calculated by P<sub>D</sub> (MAX) = (T<sub>J</sub> (MAX) - T<sub>A</sub>) / θ<sub>JA</sub>. Exceeding the maximum allowable power dissipation can cause excessive die temperature, and the converter may go into thermal shutdown. Internal thermal shutdown circuitry protects the device from permanent damage.
- 3) Operating junction temperatures above 125°C may be supported. Contact MPS for more details.
- 4) Measured on JESD51-7, 4-layer PCB. The values given in this table are only valid for comparison with other packages and cannot be used for design purposes. These values were calculated in accordance with JESD51-7, and simulated on a specified JEDEC board. They do not represent the performance obtained in an actual application.
- 5) Measured on EVQ4312-R-00A (9cmx9cm), 2oz copper thickness, 4-layer PCB.

## ELECTRICAL CHARACTERISTICS

V<sub>IN</sub> = 12V, V<sub>EN</sub> = 2V, T<sub>J</sub> = -40°C to +125°C <sup>(6)</sup>, typical values are tested at T<sub>J</sub> = 25°C, unless otherwise noted.

Parameter	Symbol	Condition	Min	Typ	Max	Units
V <sub>IN</sub> under-voltage lockout (UVLO) rising threshold	V <sub>IN_UVLO_RISING</sub>		2.8	3	3.2	V
V <sub>IN</sub> UVLO falling threshold	V <sub>IN_UVLO_FALLING</sub>		2.5	2.7	2.9	V
V <sub>IN</sub> UVLO hysteresis	V <sub>IN_UVLO_HYS</sub>			280		mV
VCC voltage	V <sub>CC</sub>	I <sub>VCC</sub> = 0A	4.6	4.9	5.2	V
VCC regulation		I <sub>VCC</sub> = 30mA		1	4	%
VCC current limit	I <sub>LIMIT_VCC</sub>	V <sub>CC</sub> = 4V	100			mA
Quiescent current during sleep mode	I <sub>SLEEP</sub>	V <sub>FB</sub> = 0.85V, sleep mode, no load		18	26	μA
Quiescent current <sup>(7)</sup>	I <sub>Q</sub>	MODE is low, AAM mode, no load, switching, R <sub>FB_PU</sub> = 1MΩ, R <sub>FB_PD</sub> = 316kΩ		20		μA
		MODE is high, FCCM, no load, switching, f <sub>sw</sub> = 2MHz		40		mA
		MODE is high, FCCM, no load, switching, f <sub>sw</sub> = 470kHz		9.5		mA
Shutdown current	I <sub>SD</sub>	V <sub>EN</sub> = 0V		1.7	3.5	μA
Feedback (FB) voltage	V <sub>FB</sub>	V <sub>IN</sub> = 3.3V to 45V, T <sub>J</sub> = 25°C	0.807	0.815	0.823	V
		V <sub>IN</sub> = 3.3V to 45V	0.799	0.815	0.831	V
FB current	I <sub>FB</sub>	V <sub>FB</sub> = 0.85V	-50	0	+50	nA
Switching frequency	f <sub>SW</sub>	R <sub>FREQ</sub> = 62kΩ	420	470	520	kHz
		R <sub>FREQ</sub> = 26.1kΩ	820	1000	1180	
Minimum on time <sup>(7)</sup>	t <sub>ON_MIN</sub>			100		ns
Minimum off time <sup>(7)</sup>	t <sub>OFF_MIN</sub>			80		ns
SYNCIN voltage rising threshold	V <sub>SYNCIN_RISING</sub>		1.8			V
SYNCIN voltage falling threshold	V <sub>SYNCIN_FALLING</sub>				0.4	V
SYNCIN clock frequency	f <sub>SYNC</sub>	External Clock	350		1000	kHz
SYNCO high voltage	V <sub>SYNCO_HIGH</sub>	I <sub>SYNCO</sub> = -1mA	3.3	4.5		V
SYNCO low voltage	V <sub>SYNCO_LOW</sub>	I <sub>SYNCO</sub> = 1mA			0.4	V
SYNCO phase shift		Tested under SYNCIN		180		deg
High-side MOSFET (HS-FET) peak current limit	I <sub>LIMIT_PEAK</sub>	30% duty cycle	4.4	5.5	6.6	A
Low-side MOSFET (LS-FET) valley current limit	I <sub>LIMIT_VALLEY</sub>		3.2	4	4.8	A
Zero-current detection (ZCD) current	I <sub>ZCD</sub>	AAM mode	-0.15	+0.1	+0.35	A
LS-FET reverse current limit	I <sub>LIMIT_REVERSE</sub>	FCCM	2	4.5	7	A
Switch leakage current	I <sub>SW_LKG</sub>			0.01	1	μA

## ELECTRICAL CHARACTERISTICS (continued)

V<sub>IN</sub> = 12V, V<sub>EN</sub> = 2V, T<sub>J</sub> = -40°C to +125°C <sup>(6)</sup>, typical values are tested at T<sub>J</sub> = 25°C, unless otherwise noted.

Parameter	Symbol	Condition	Min	Typ	Max	Units
HS-FET on resistance	R <sub>DS(ON)_HS</sub>	V <sub>BST</sub> - V <sub>SW</sub> = 5V		48	80	mΩ
LS-FET on resistance	R <sub>DS(ON)_LS</sub>	V <sub>CC</sub> = 5V		20	40	mΩ
Soft-start current	I <sub>SS</sub>	V <sub>SS</sub> = 0V	8	13	19	μA
EN rising threshold	V <sub>EN_RISING</sub>		0.8	1	1.2	V
EN falling threshold	V <sub>EN_FALLING</sub>		0.65	0.85	1.05	V
EN hysteresis	V <sub>EN_HYS</sub>			190		mV
MODE rising threshold	V <sub>MODE_RISING</sub>		1.8			V
MODE falling threshold	V <sub>MODE_FALLING</sub>				0.4	V
PG rising threshold	V <sub>PG_RISING</sub>	V <sub>FB</sub> rising, V <sub>FB</sub> / V <sub>REF</sub>	92	95	98	% of V <sub>REF</sub>
		V <sub>FB</sub> falling, V <sub>FB</sub> / V <sub>REF</sub>	102	105	108	
PG falling threshold	V <sub>PG_FALLING</sub>	V <sub>FB</sub> falling, V <sub>FB</sub> / V <sub>REF</sub>	90.5	93.5	96.5	% of V <sub>REF</sub>
		V <sub>FB</sub> rising, V <sub>FB</sub> / V <sub>REF</sub>	103.5	106.5	109.5	
PG output voltage low	V <sub>PG_LOW</sub>	I <sub>SINK</sub> = 1mA		0.1	0.3	V
PG rising delay	t <sub>PG_DELAY_RISING</sub>			35		μs
PG falling delay	t <sub>PG_DELAY_FALLING</sub>			35		μs
Thermal shutdown <sup>(7)</sup>	T <sub>SD</sub>			170		°C
Thermal shutdown hysteresis <sup>(7)</sup>	T <sub>SD_HYS</sub>			20		°C

**Notes:**

- 6) Guaranteed by over-temperature correlation. Not tested in production.
- 7) Derived from bench characterization. Not tested in production.

## TYPICAL CHARACTERISTICS

V<sub>IN</sub> = 12V, T<sub>J</sub> = -40°C to +125°C, unless otherwise noted.

**Quiescent Current vs. Temperature**

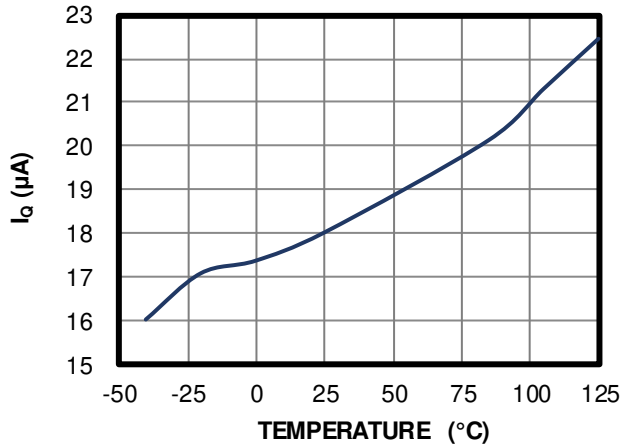

**Feedback Voltage vs. Temperature**

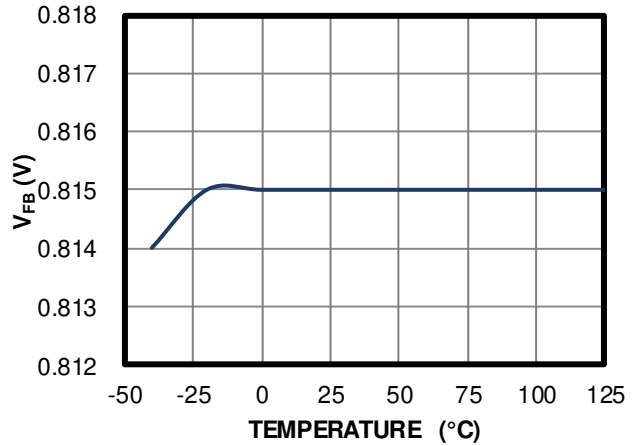

**Current Limit vs. Temperature**

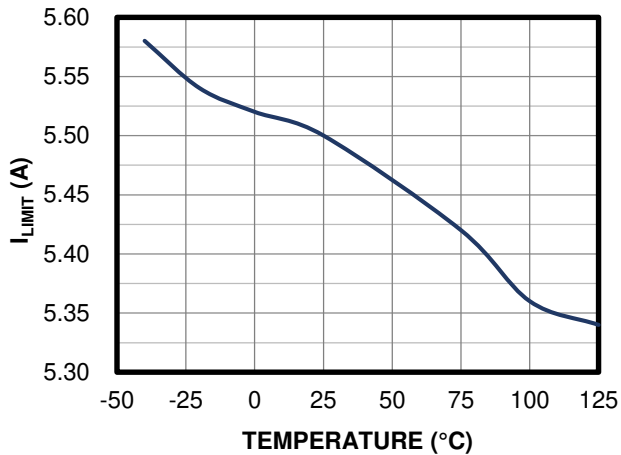

**Valley Current Limit vs. Temperature**

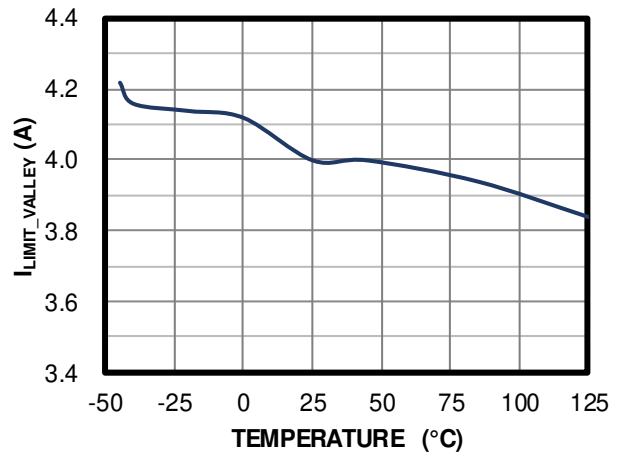

**Reverse Current Limit vs. Temperature**

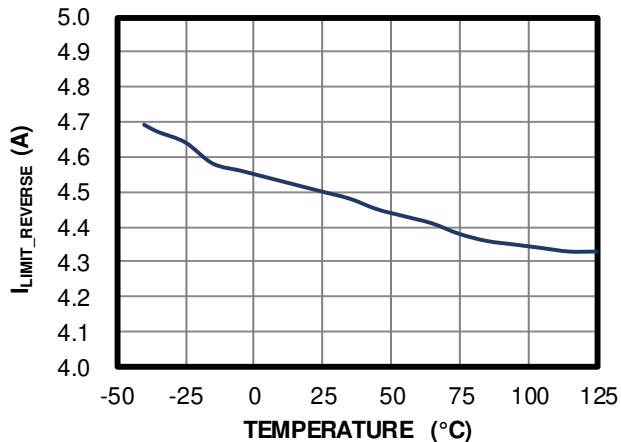

**V<sub>IN</sub> UVLO Threshold vs. Temperature**

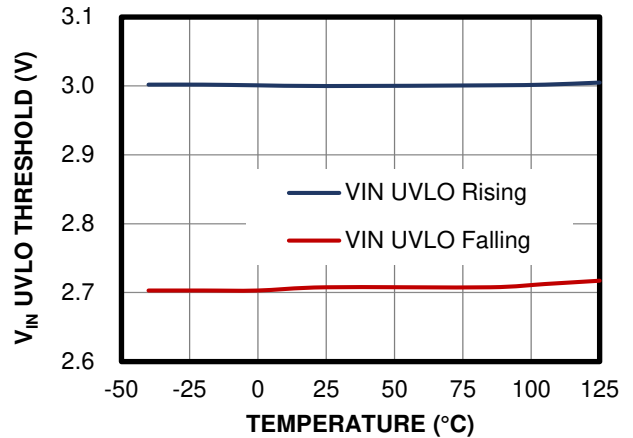



**TYPICAL CHARACTERISTICS** (continued)

V<sub>IN</sub> = 12V, T<sub>J</sub> = -40°C to +125°C, unless otherwise noted.

**EN UVLO Threshold vs. Temperature**

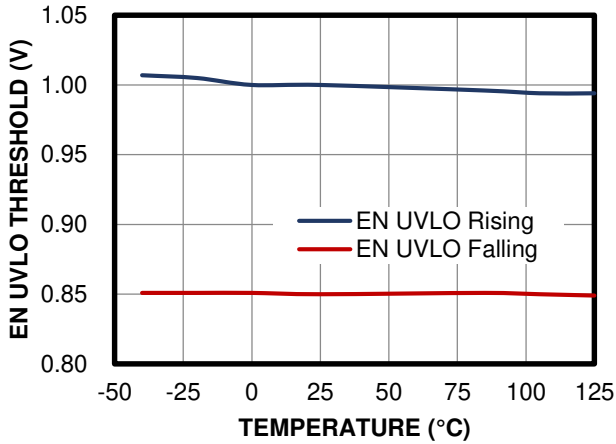

**PG Threshold vs. Temperature**

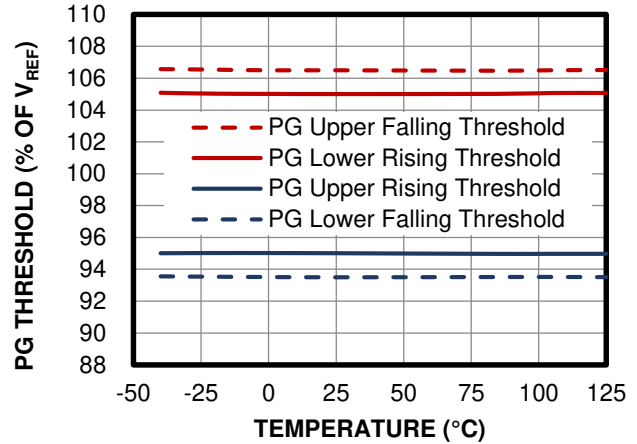

**Shutdown Current vs. Temperature**

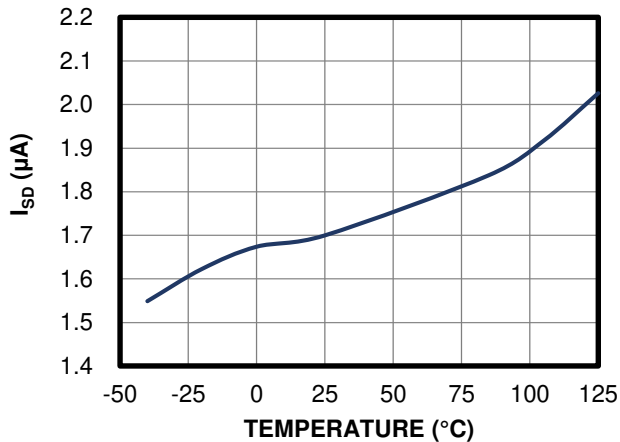

**HS-FET On Resistance vs. Temperature**

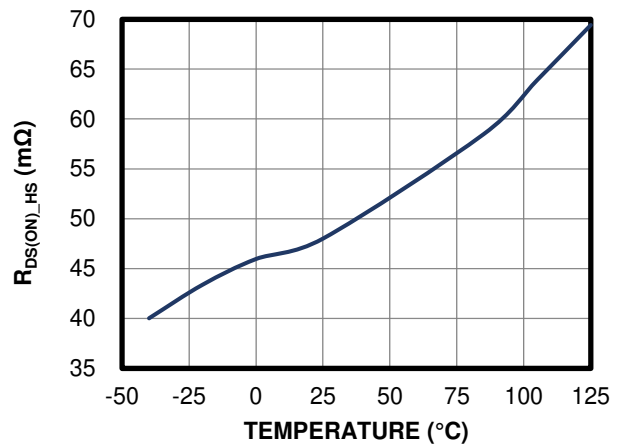

**LS-FET On Resistance vs. Temperature**

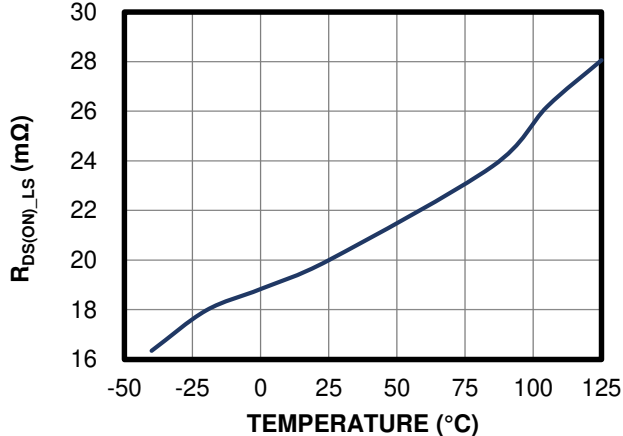

**V<sub>CC</sub> vs. Temperature**

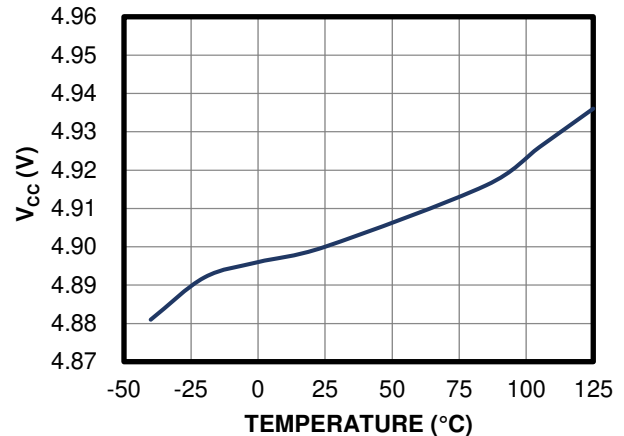

**TYPICAL CHARACTERISTICS** *(continued)*

V<sub>IN</sub> = 12V, T<sub>J</sub> = -40°C to +125°C, unless otherwise noted.

**Soft-Start Current vs. Temperature**

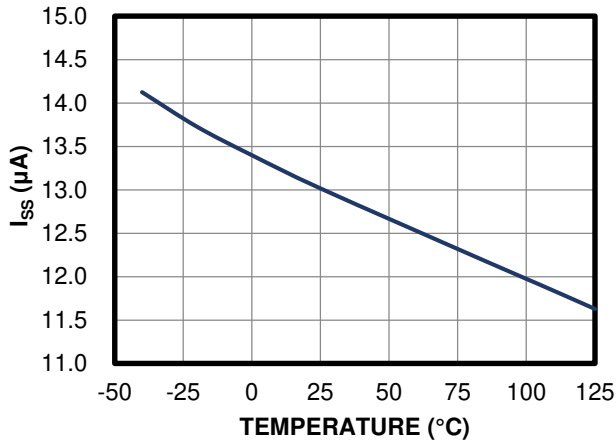

**ZCD Current vs. Temperature**

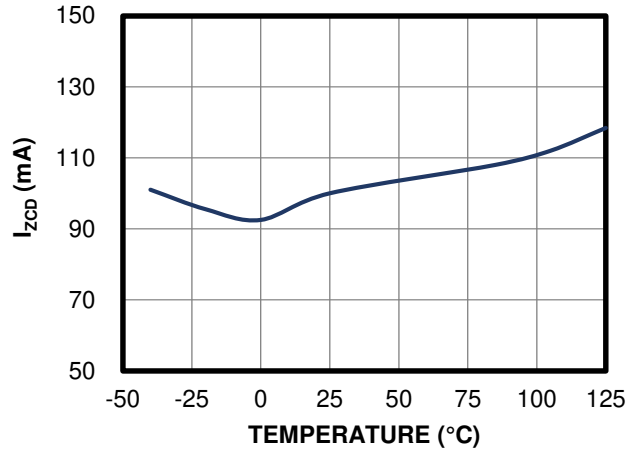

**f<sub>sw</sub> vs. Temperature**

R<sub>FREQ</sub> = 62kΩ

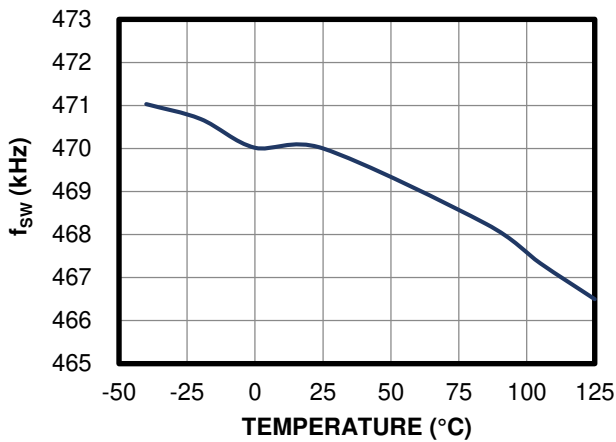

## TYPICAL PERFORMANCE CHARACTERISTICS

V<sub>IN</sub> = 12V, V<sub>OUT</sub> = 3.3V, L = 5.6μH<sup>(8)</sup>, f<sub>sw</sub> = 470kHz, AAM mode, T<sub>A</sub> = 25°C, unless otherwise noted.

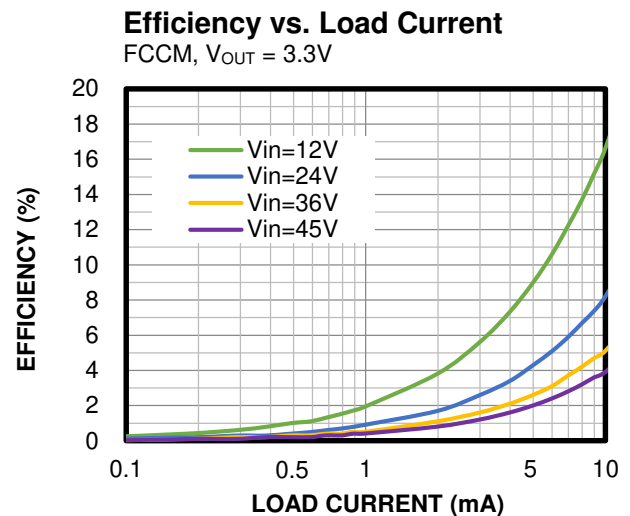
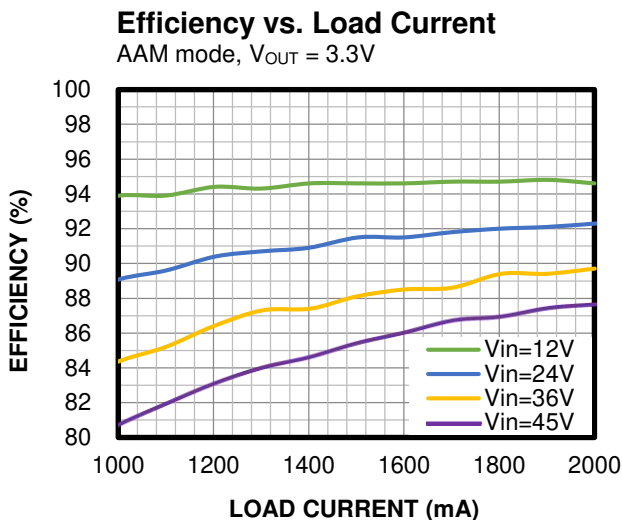
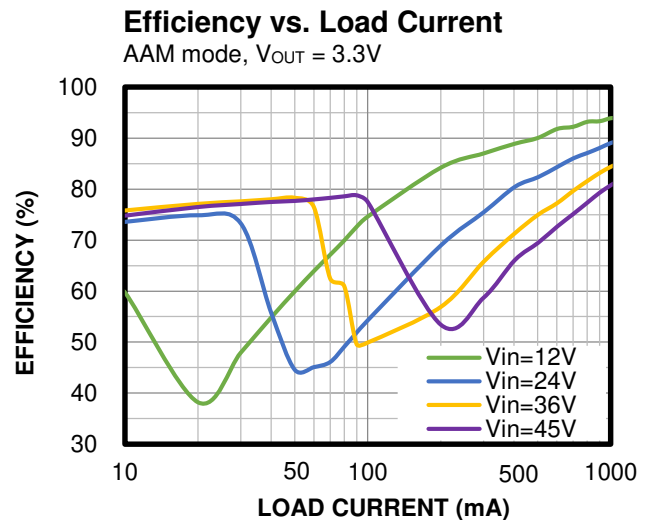
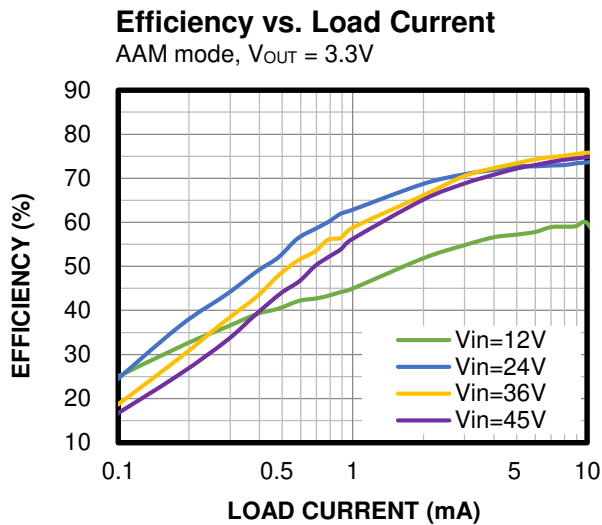
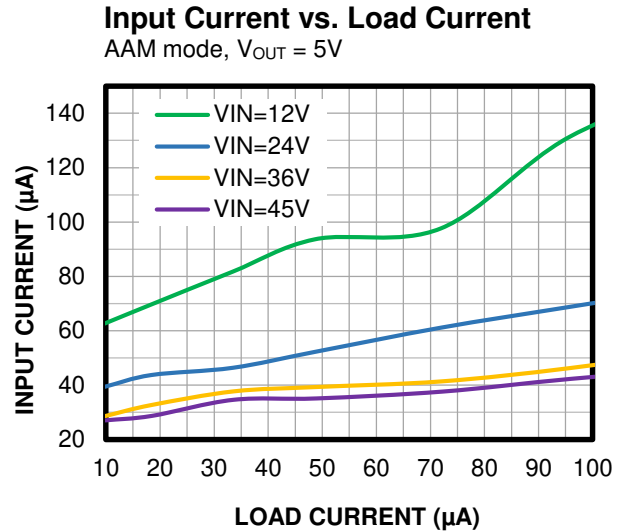
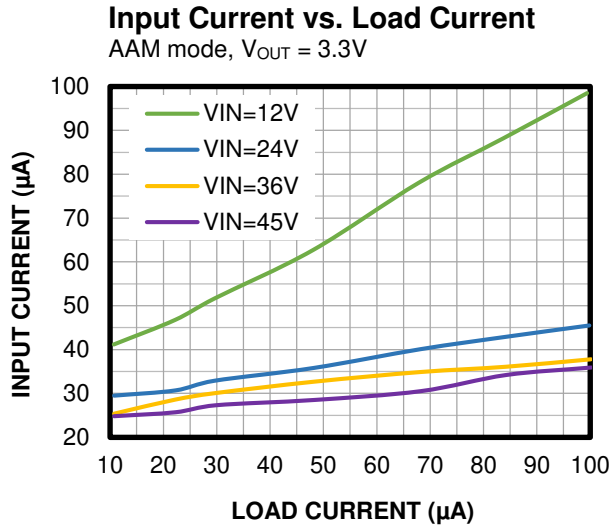

### TYPICAL PERFORMANCE CHARACTERISTICS (continued)

V<sub>IN</sub> = 12V, V<sub>OUT</sub> = 3.3V, L = 5.6μH<sup>(8)</sup>, f<sub>sw</sub> = 470kHz, AAM mode, T<sub>A</sub> = 25°C, unless otherwise noted.

**Efficiency vs. Load Current**

FCCM, V<sub>OUT</sub> = 3.3V

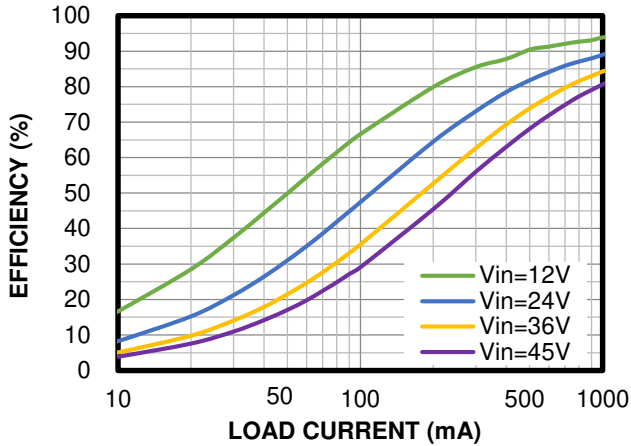

**Efficiency vs. Load Current**

FCCM, V<sub>OUT</sub> = 3.3V

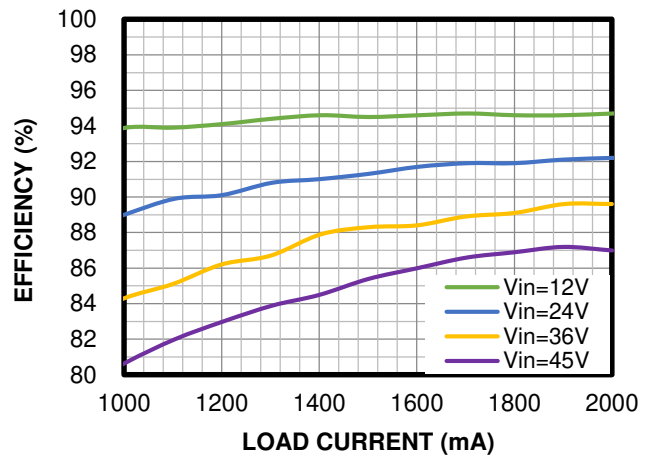

**Efficiency vs. Load Current**

AAM mode, V<sub>OUT</sub> = 5V

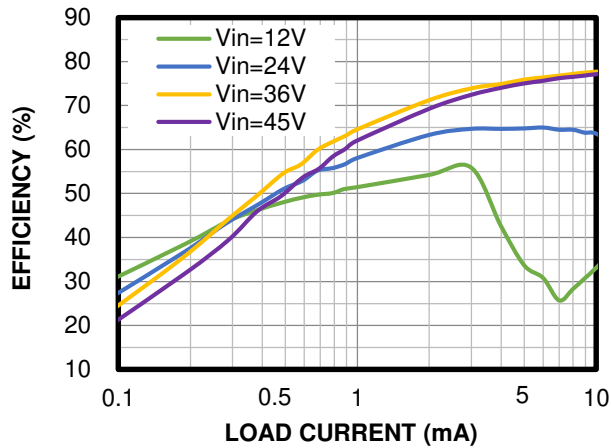

**Efficiency vs. Load Current**

AAM mode, V<sub>OUT</sub> = 5V

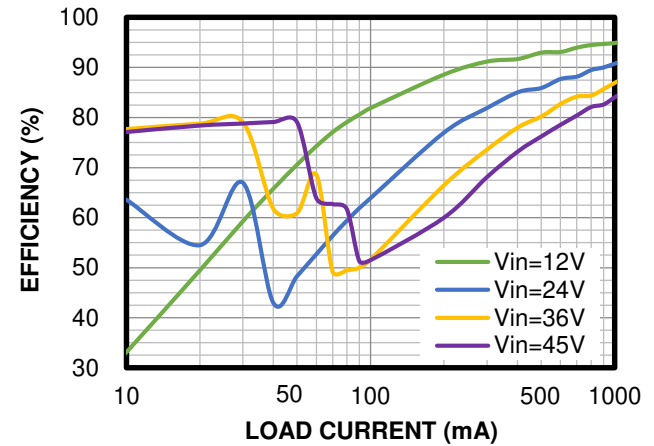

**Efficiency vs. Load Current**

AAM mode, V<sub>OUT</sub> = 5V

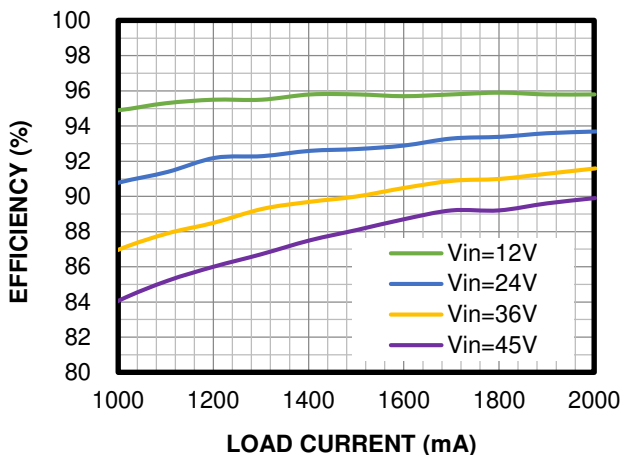

**Efficiency vs. Load Current**

FCCM, V<sub>OUT</sub> = 5V

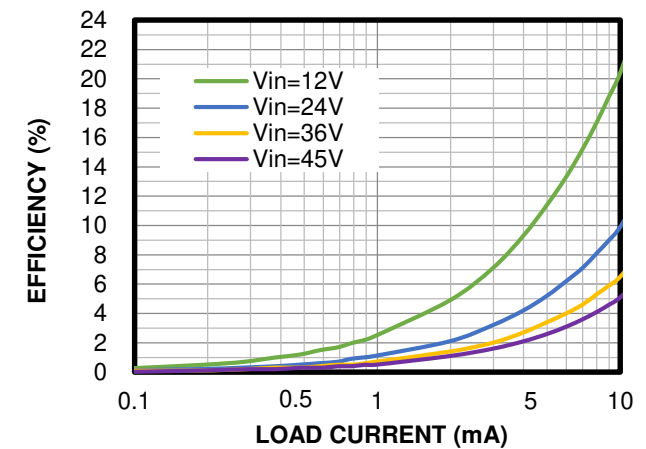

### TYPICAL PERFORMANCE CHARACTERISTICS *(continued)*

V<sub>IN</sub> = 12V, V<sub>OUT</sub> = 3.3V, L = 5.6μH<sup>(8)</sup>, f<sub>sw</sub> = 470kHz, AAM mode, T<sub>A</sub> = 25°C, unless otherwise noted.

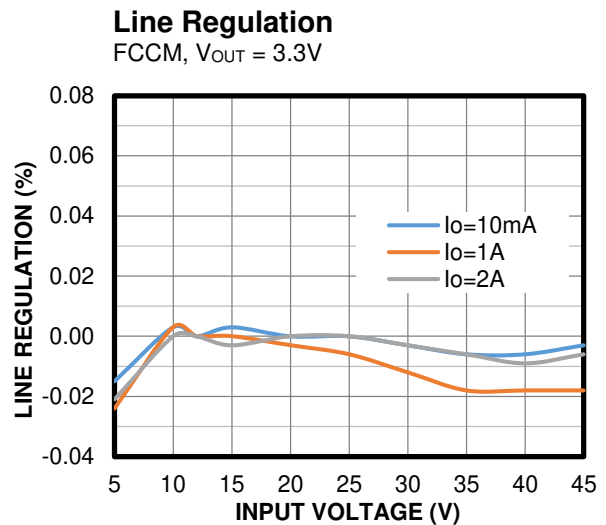
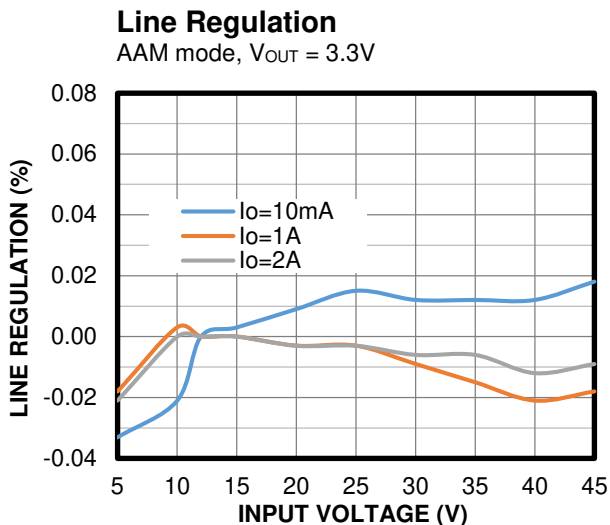
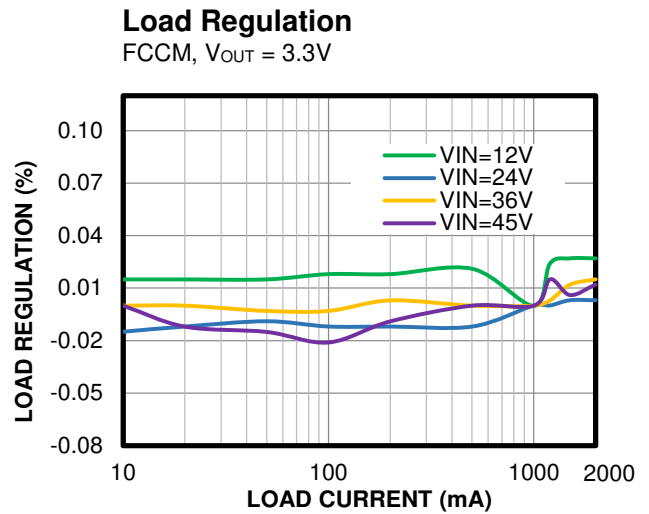
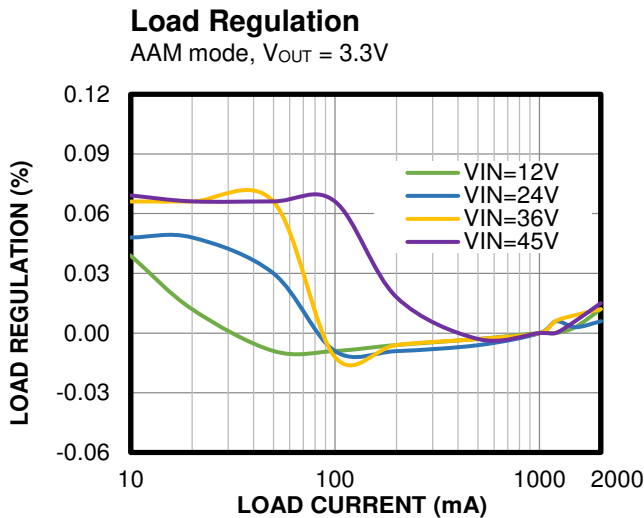
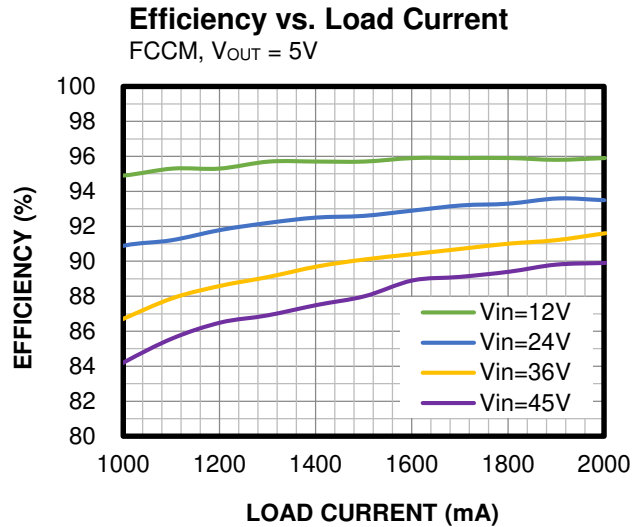
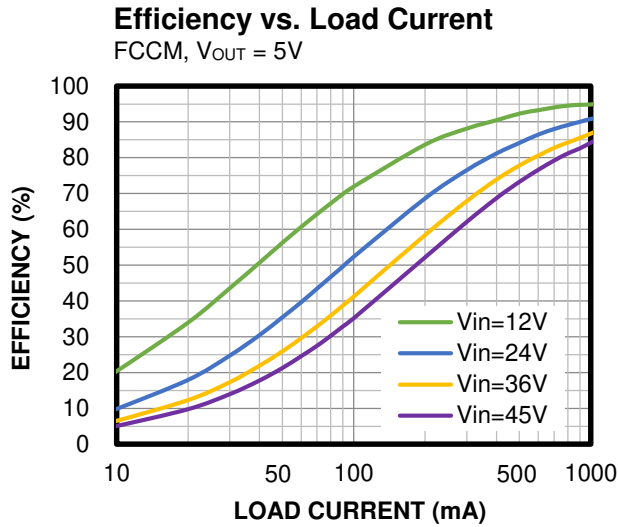

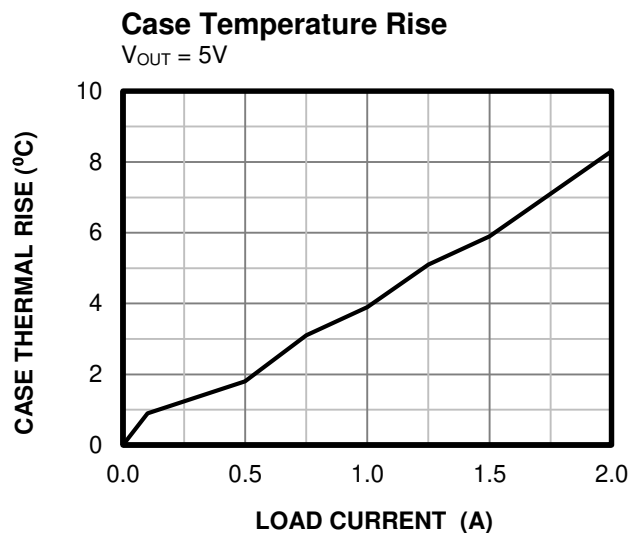
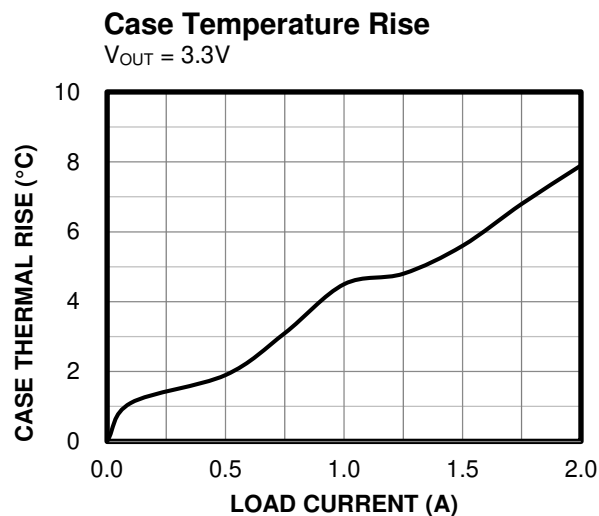
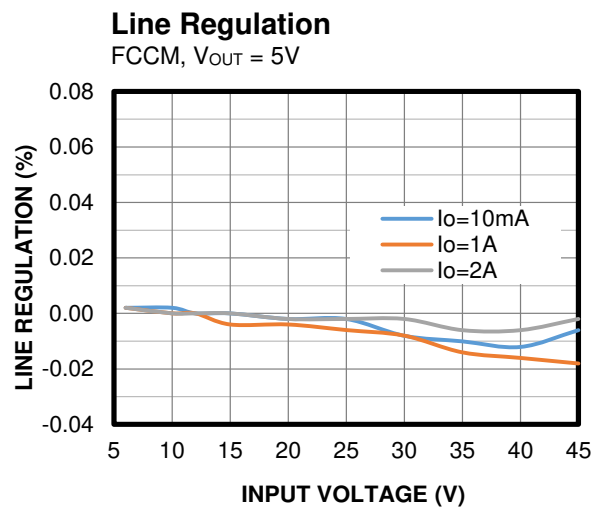
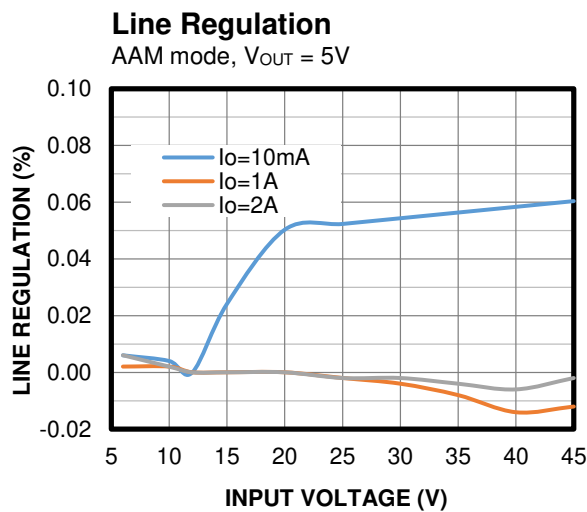
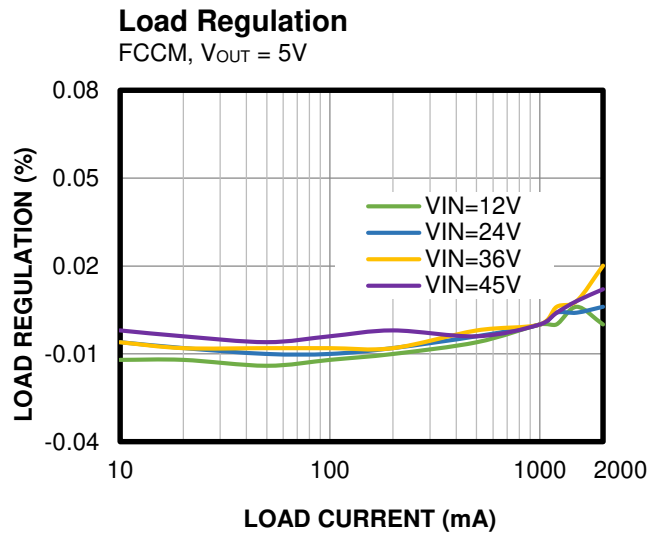
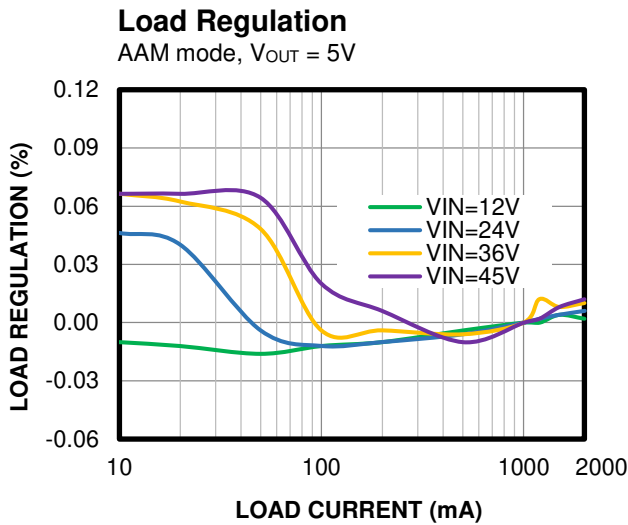
**TYPICAL PERFORMANCE CHARACTERISTICS (continued)**
 $V_{IN} = 12V, V_{OUT} = 3.3V, L = 5.6\mu H^{(8)}, f_{sw} = 470kHz, AAM \text{ mode}, T_A = 25^\circ C$ , unless otherwise noted.

**TYPICAL PERFORMANCE CHARACTERISTICS** *(continued)*

V<sub>IN</sub> = 12V, V<sub>OUT</sub> = 3.3V, L = 5.6μH<sup>(8)</sup>, f<sub>sw</sub> = 470kHz, AAM mode, T<sub>A</sub> = 25°C, unless otherwise noted.

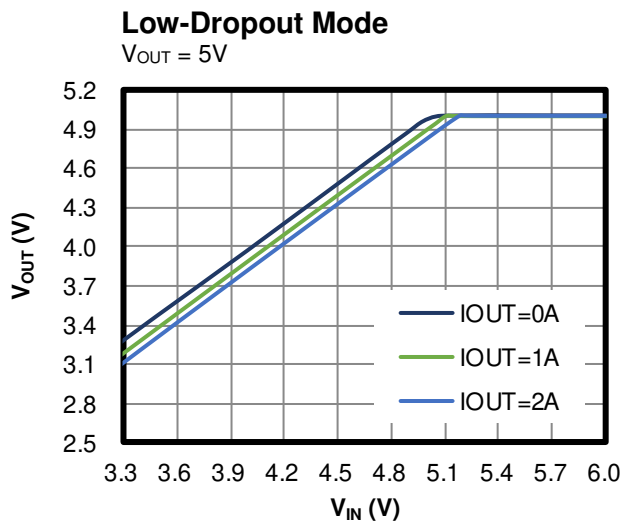
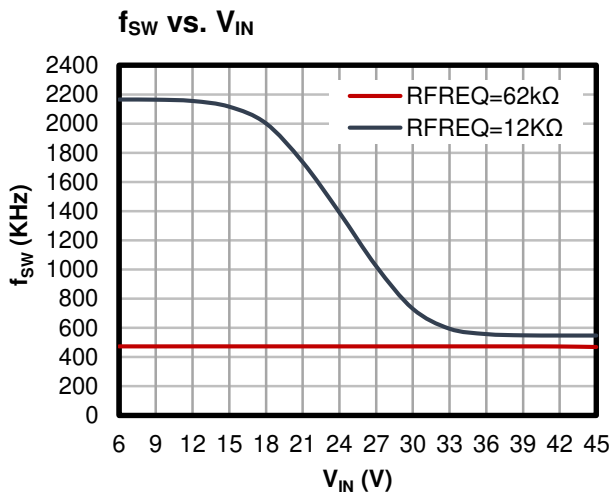
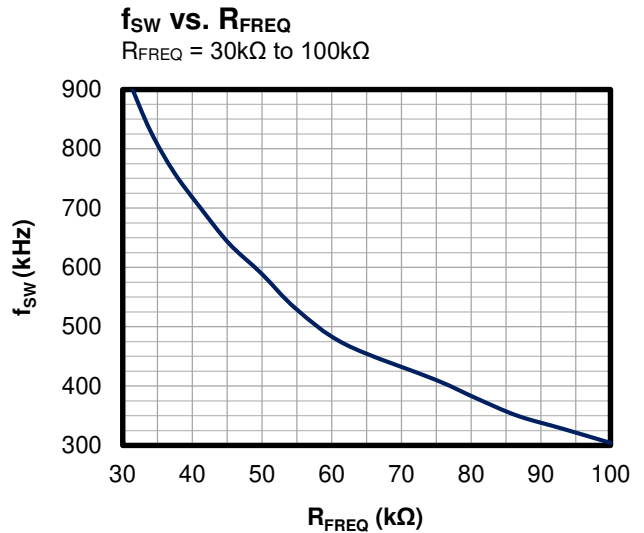
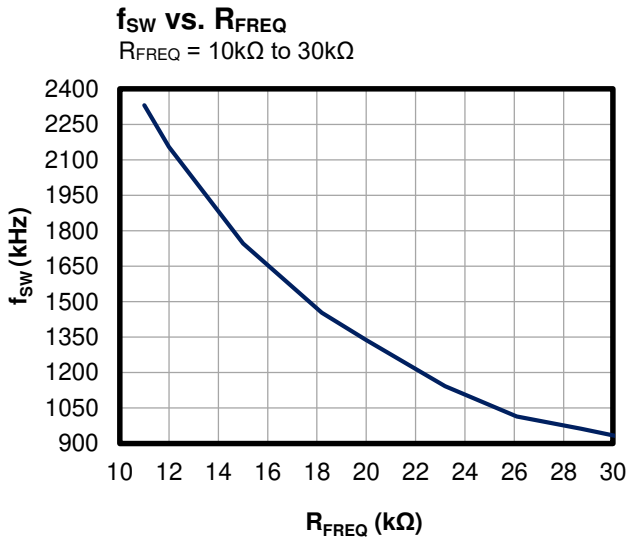

## TYPICAL PERFORMANCE CHARACTERISTICS *(continued)*

V<sub>IN</sub> = 12V, V<sub>OUT</sub> = 3.3V, I<sub>OUT</sub> = 2A, L = 5.6μH<sup>(8)</sup>, f<sub>sw</sub> = 470kHz, T<sub>A</sub> = 25°C, unless otherwise noted.<sup>(9)</sup>

### CISPR25 Class 5 Peak Conducted Emissions

150kHz to 108MHz

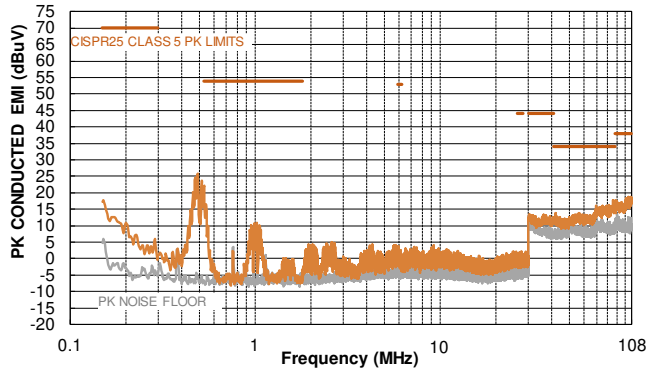

### CISPR25 Class 5 Average Conducted Emissions

150kHz to 108MHz

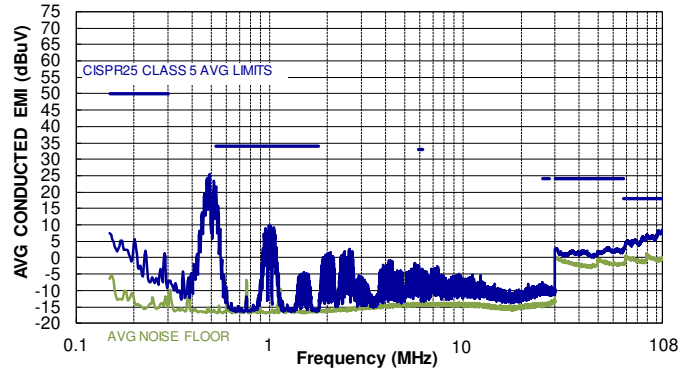

### CISPR25 Class 5 Peak Radiated Emissions

150kHz to 30MHz

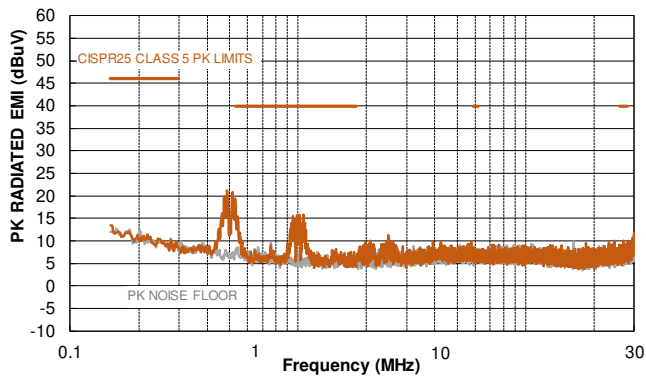

### CISPR25 Class 5 Average Radiated Emissions

150kHz to 30MHz

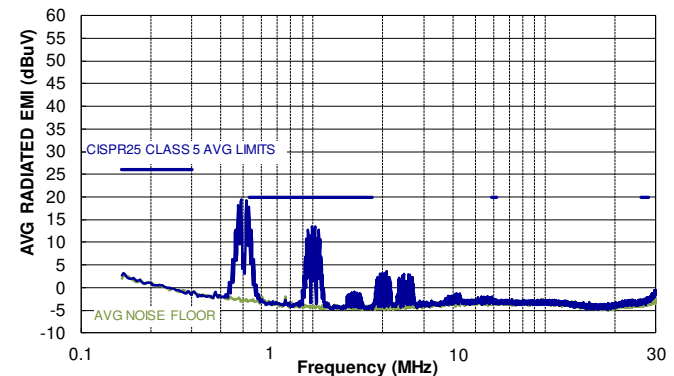

### CISPR25 Class 5 Peak Radiated Emissions

Horizontal, 30MHz to 1GHz

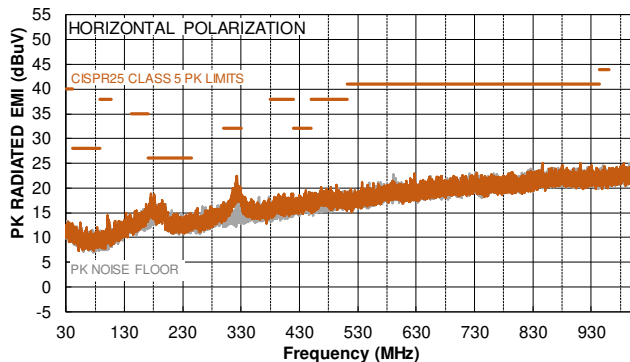

### CISPR25 Class 5 Average Radiated Emissions

Horizontal, 30MHz to 1GHz

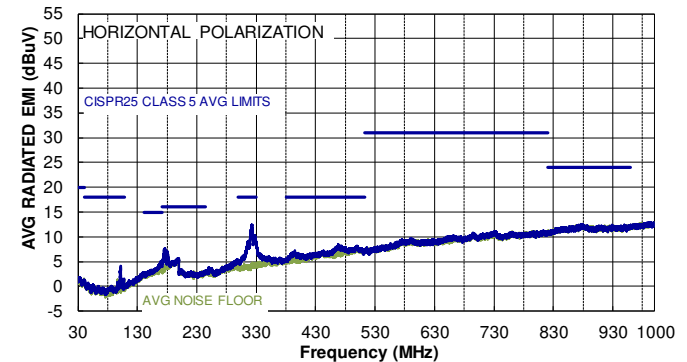



**TYPICAL PERFORMANCE CHARACTERISTICS (continued)**

V<sub>IN</sub> = 12V, V<sub>OUT</sub> = 3.3V, I<sub>OUT</sub> = 2A, L = 5.6μH <sup>(8)</sup>, f<sub>SW</sub> = 470kHz, T<sub>A</sub> = 25°C, unless otherwise noted. <sup>(9)</sup>

**CISPR25 Class 5 Peak Radiated Emissions**

Vertical, 30MHz to 1GHz

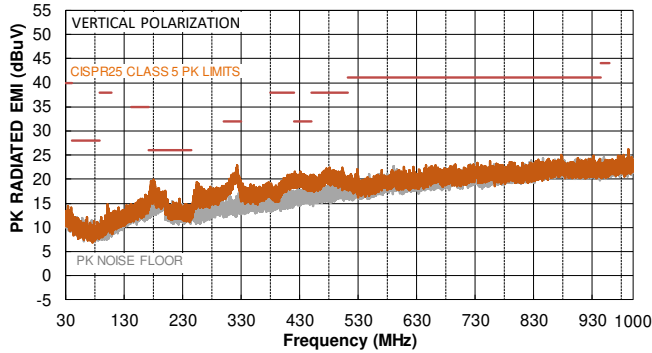

**CISPR25 Class 5 Average Radiated Emissions**

Vertical, 30MHz to 1GHz

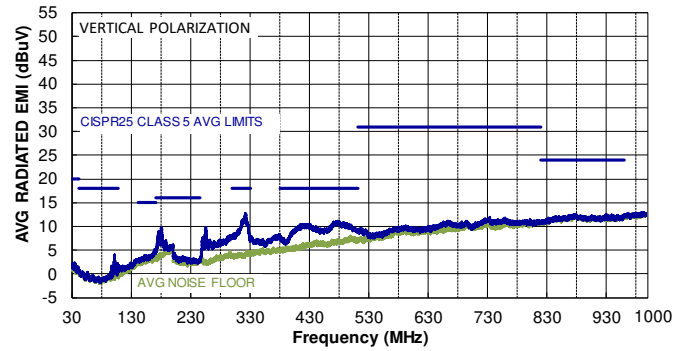

**Notes:**

- 8) Inductor part number: XAL6060-562MEC; DCR = 14.5mΩ.
- 9) The EMC test results are based on the typical application circuit with EMI filters (see Figure 11 on page 35).

**TYPICAL PERFORMANCE CHARACTERISTICS** (continued)

V<sub>IN</sub> = 12V, V<sub>OUT</sub> = 3.3V, L = 5.6μH, f<sub>SW</sub> = 470kHz, AAM mode, T<sub>A</sub> = 25°C, unless otherwise noted.

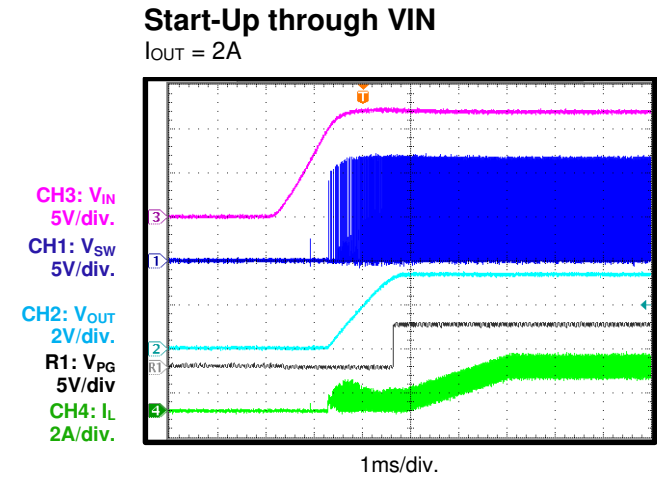
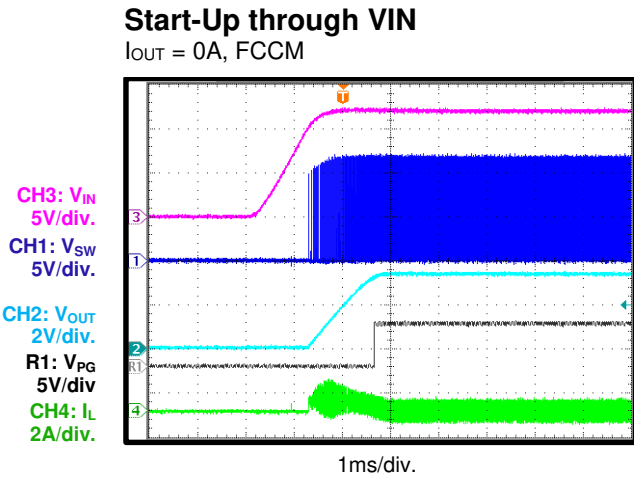
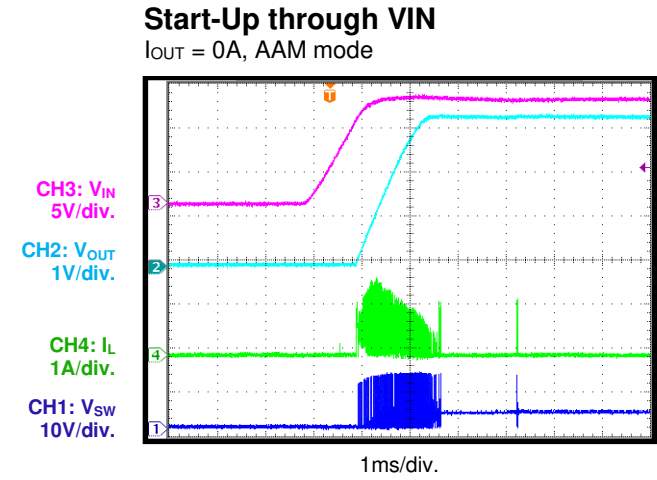
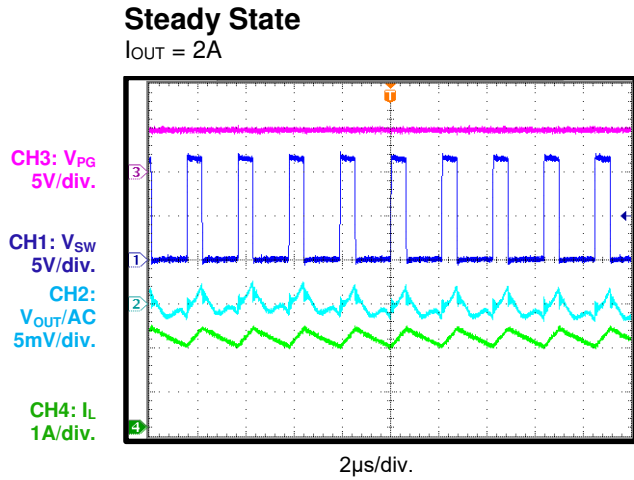
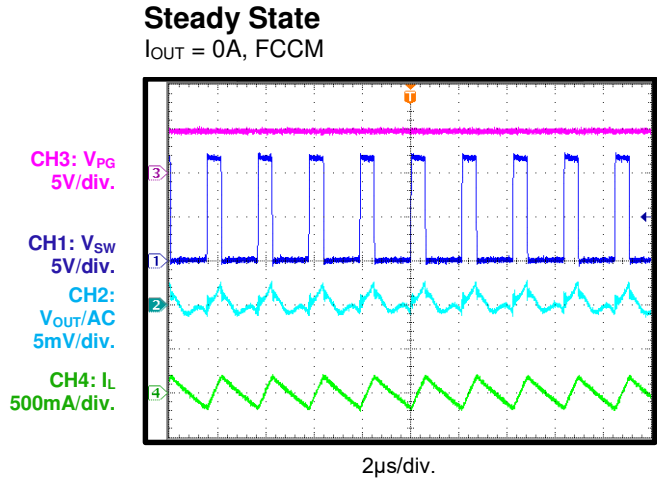
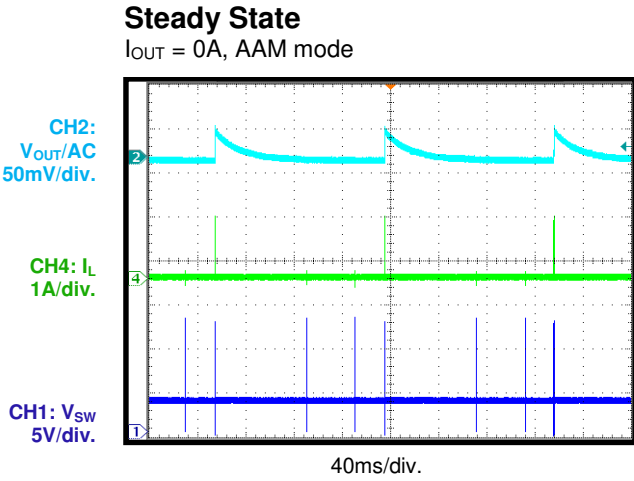

**TYPICAL PERFORMANCE CHARACTERISTICS** (continued)

V<sub>IN</sub> = 12V, V<sub>OUT</sub> = 3.3V, L = 5.6μH, f<sub>SW</sub> = 470kHz, AAM mode, T<sub>A</sub> = 25°C, unless otherwise noted.

**Shutdown through VIN**

I<sub>OUT</sub> = 0A, AAM mode

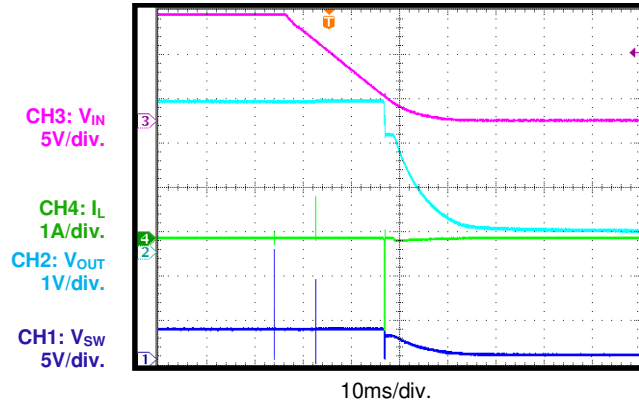

**Shutdown through VIN**

I<sub>OUT</sub> = 0A, FCCM

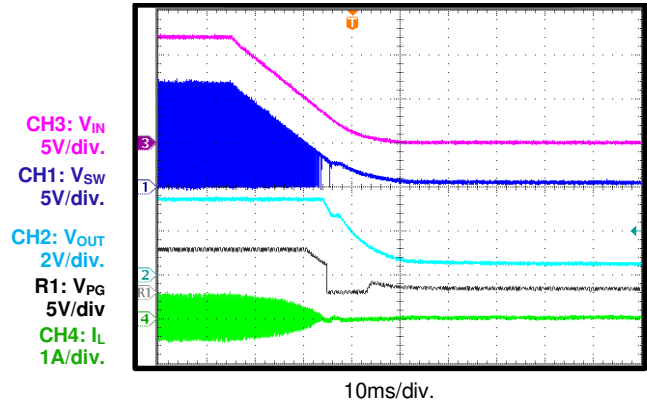

**Shutdown through VIN**

I<sub>OUT</sub> = 2A

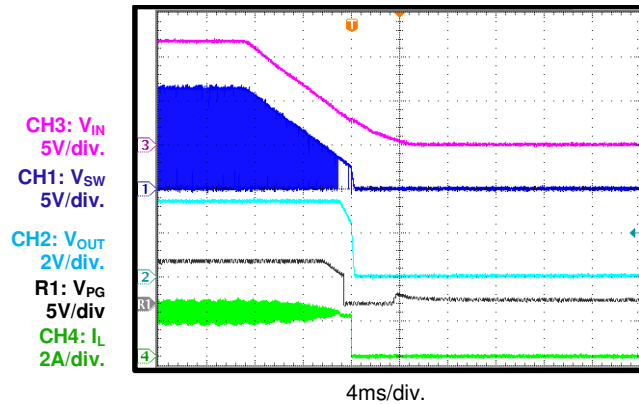

**Start-Up through EN**

I<sub>OUT</sub> = 0A, AAM mode

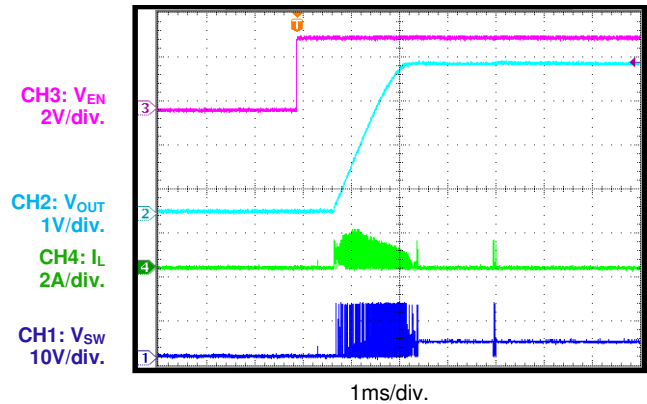

**Start-Up through EN**

I<sub>OUT</sub> = 0A, FCCM

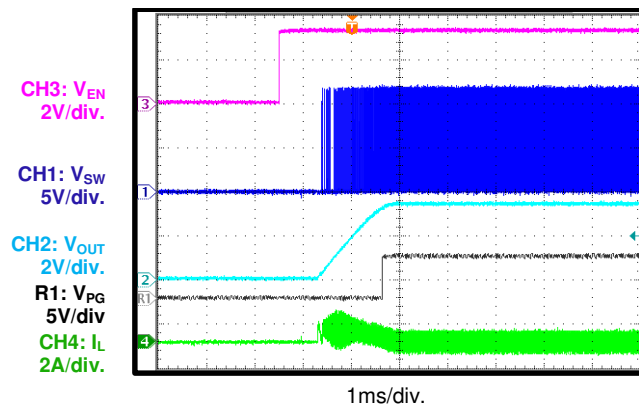

**Start-Up through EN**

I<sub>OUT</sub> = 2A

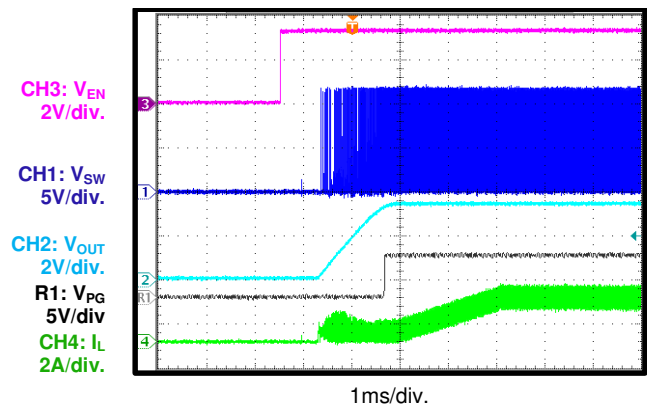

**TYPICAL PERFORMANCE CHARACTERISTICS** (continued)

V<sub>IN</sub> = 12V, V<sub>OUT</sub> = 3.3V, L = 5.6μH, f<sub>SW</sub> = 470kHz, AAM mode, T<sub>A</sub> = 25°C, unless otherwise noted.

**Shutdown through EN**

I<sub>OUT</sub> = 0A, AAM mode

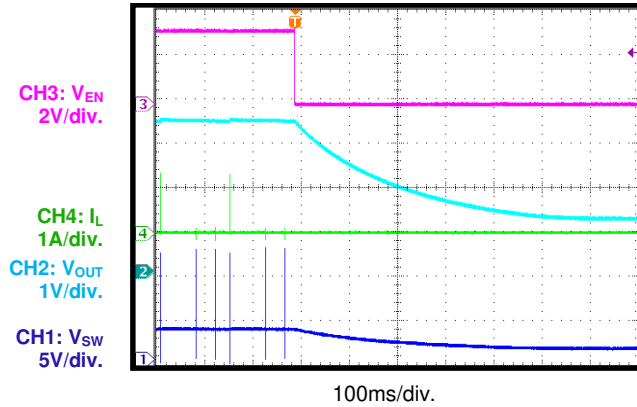

**Shutdown through EN**

I<sub>OUT</sub> = 0A, FCCM

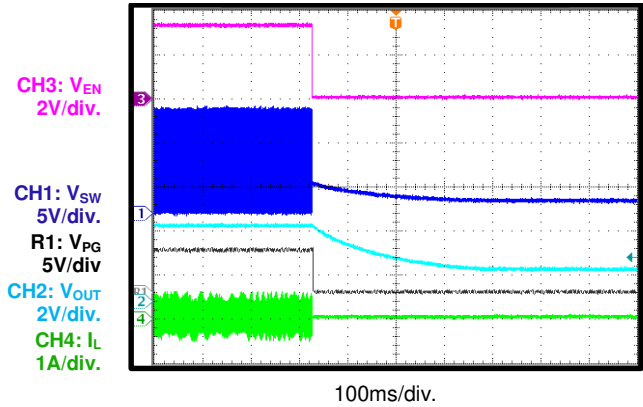

**Shutdown through EN**

I<sub>OUT</sub> = 2A

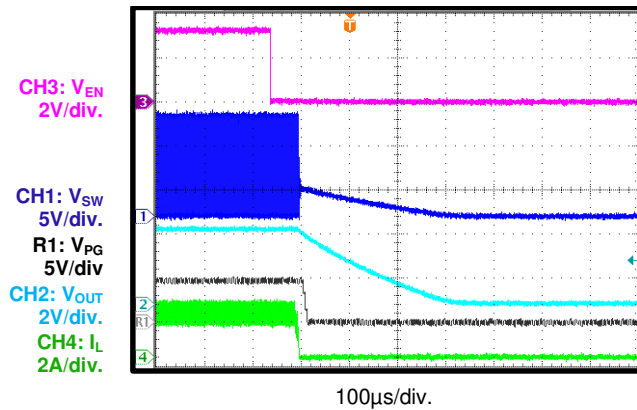

**SCP Entry**

I<sub>OUT</sub> = 0A, AAM mode

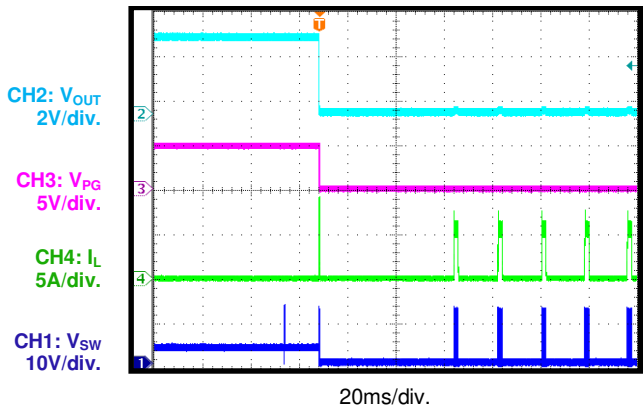

**SCP Entry**

I<sub>OUT</sub> = 0A, FCCM

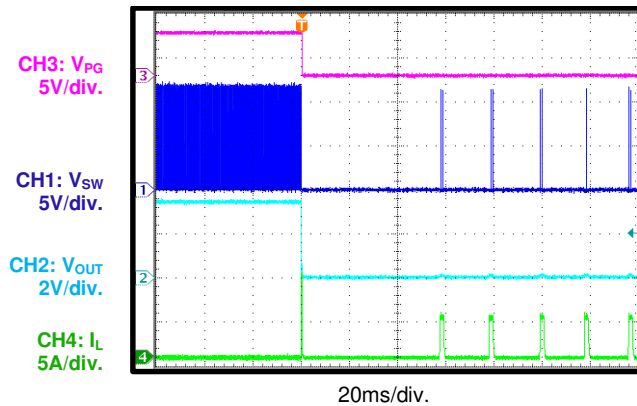

**SCP Entry**

I<sub>OUT</sub> = 2A

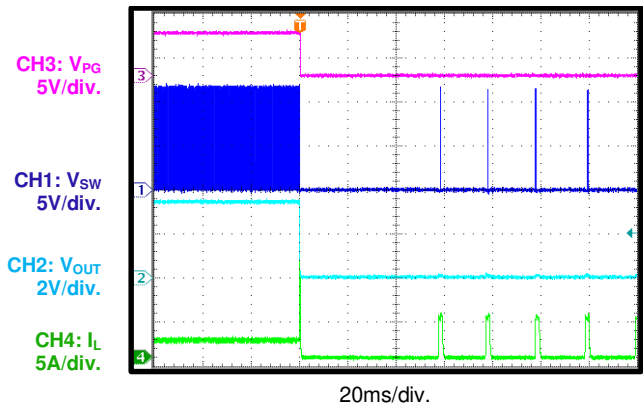

**TYPICAL PERFORMANCE CHARACTERISTICS** (continued)

V<sub>IN</sub> = 12V, V<sub>OUT</sub> = 3.3V, L = 5.6μH, f<sub>SW</sub> = 470kHz, AAM mode, T<sub>A</sub> = 25°C, unless otherwise noted.

**SCP Recovery**

I<sub>OUT</sub> = 0A, AAM mode

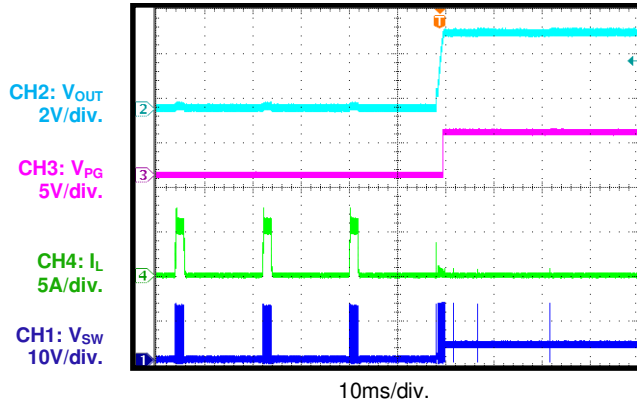

**SCP Recovery**

I<sub>OUT</sub> = 0A, FCCM

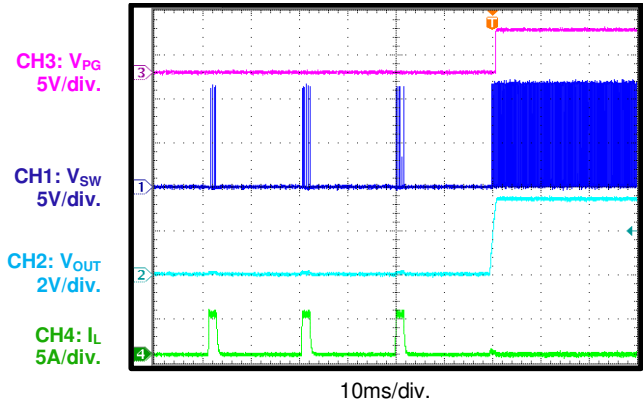

**SCP Recovery**

I<sub>OUT</sub> = 2A

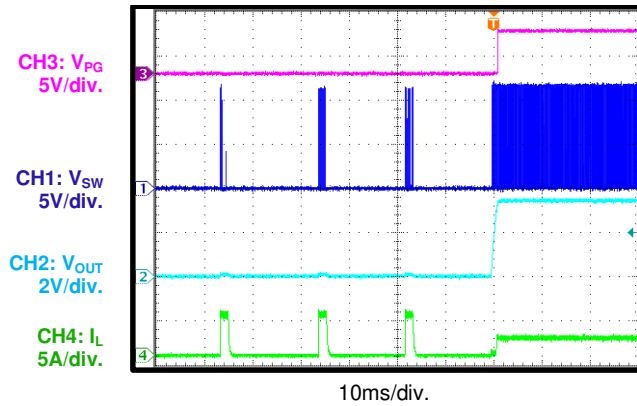

**SCP Steady State**

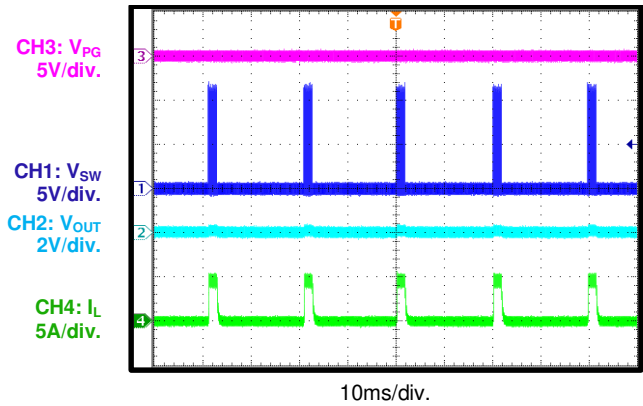

**Load Transient**

I<sub>OUT</sub> = 1A to 2A, 1.6A/μs

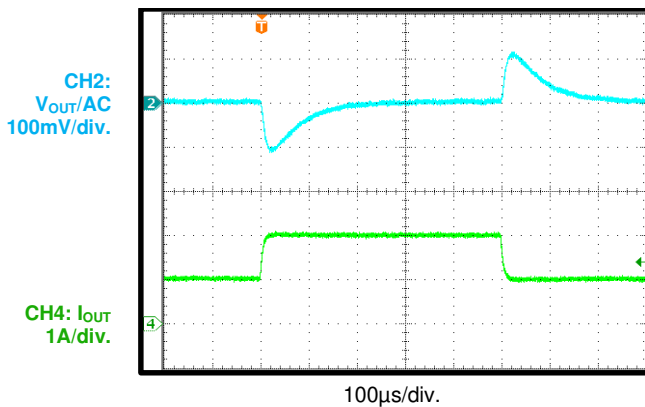

**SYNCIN Operation**

I<sub>OUT</sub> = 2A, f<sub>SYNC</sub> = 350kHz

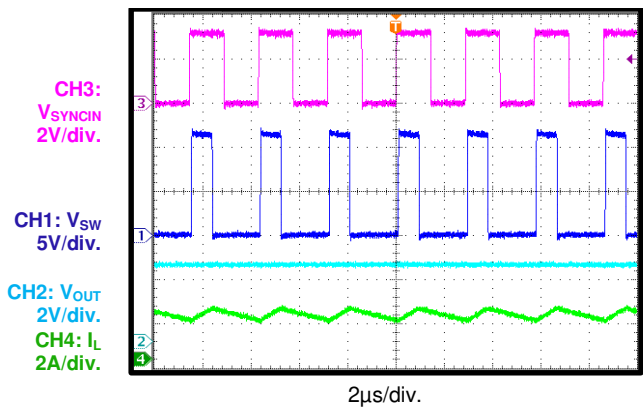

**TYPICAL PERFORMANCE CHARACTERISTICS** (continued)

V<sub>IN</sub> = 12V, V<sub>OUT</sub> = 3.3V, L = 5.6μH, f<sub>SW</sub> = 470kHz, AAM mode, T<sub>A</sub> = 25°C, unless otherwise noted.

**SYNCIN Operation**

I<sub>OUT</sub> = 2A, f<sub>SYNC</sub> = 1000kHz

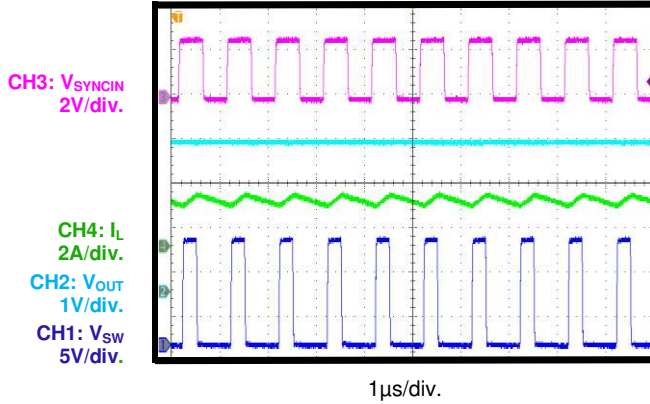

**SYNCO Operation**

I<sub>OUT</sub> = 2A, f<sub>SYNC</sub> = 350kHz

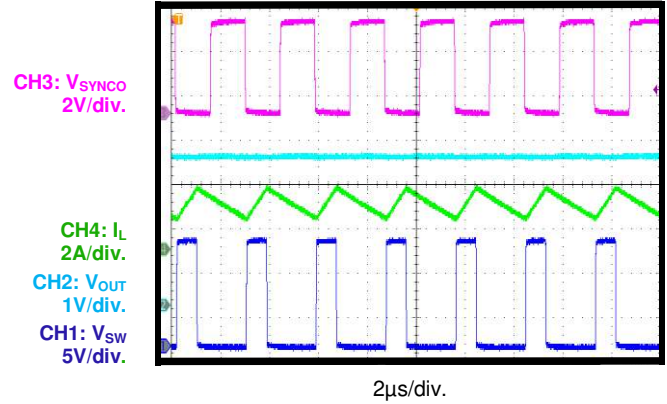

**SYNCO Operation**

I<sub>OUT</sub> = 2A, f<sub>SYNC</sub> = 1000kHz

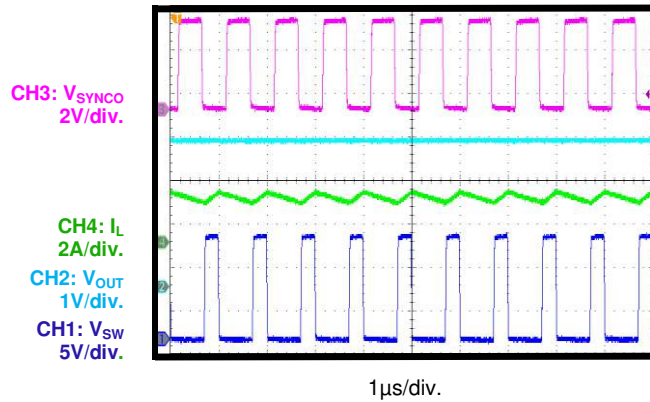

**PG Start-Up through VIN**

I<sub>OUT</sub> = 0A, AAM mode

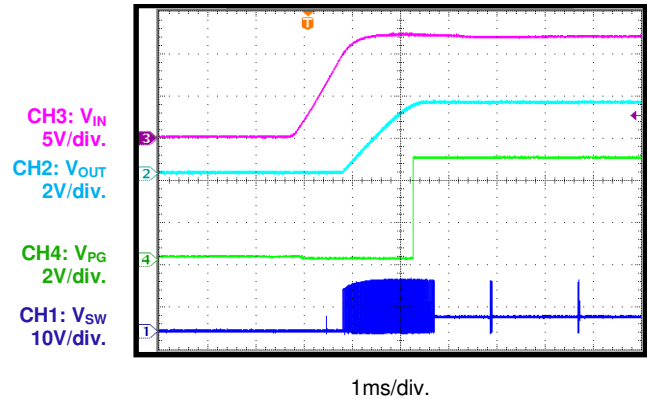

**PG Shutdown through VIN**

I<sub>OUT</sub> = 0A, AAM mode

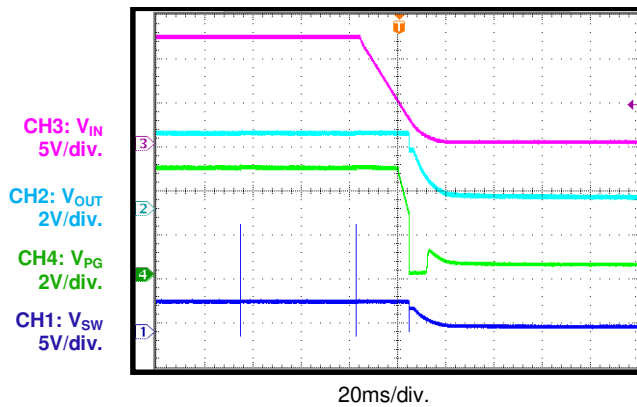

**PG Start-Up through EN**

I<sub>OUT</sub> = 0A, AAM mode

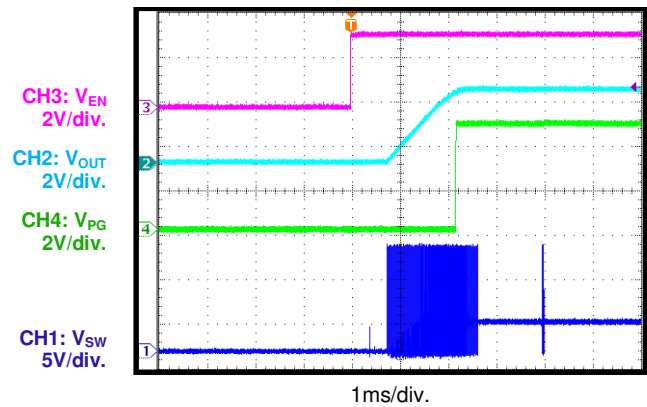

**TYPICAL PERFORMANCE CHARACTERISTICS** *(continued)*

V<sub>IN</sub> = 12V, V<sub>OUT</sub> = 3.3V, L = 5.6μH, f<sub>sw</sub> = 470kHz, AAM mode, T<sub>A</sub> = 25°C, unless otherwise noted.

**PG Shutdown through EN**

I<sub>OUT</sub> = 0A, AAM mode

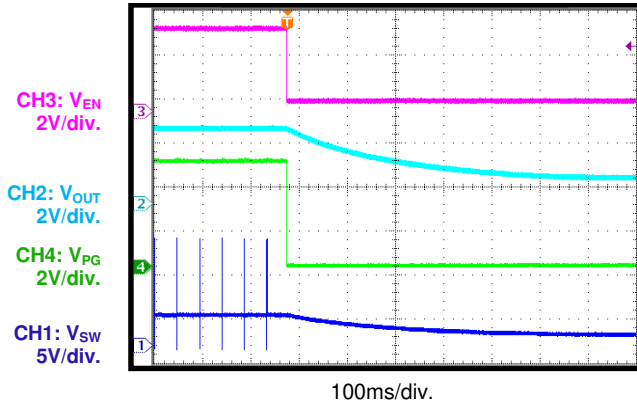

**Low-Dropout Mode**

V<sub>IN</sub> = 3.3V, V<sub>OUT</sub> = 3.3V, I<sub>OUT</sub> = 0A

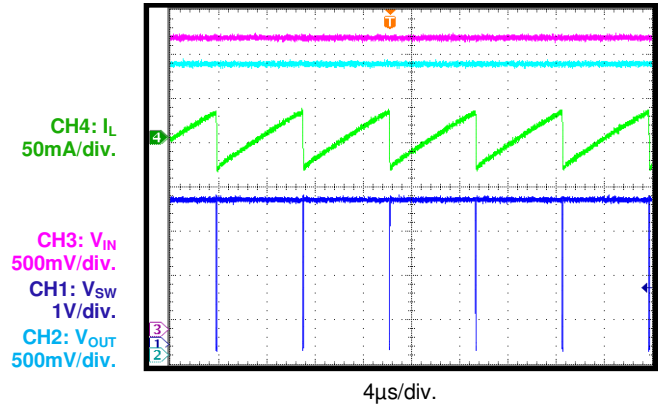

**Low-Dropout Mode**

V<sub>IN</sub> = 3.3V, V<sub>OUT</sub> = 3.3V, I<sub>OUT</sub> = 2A

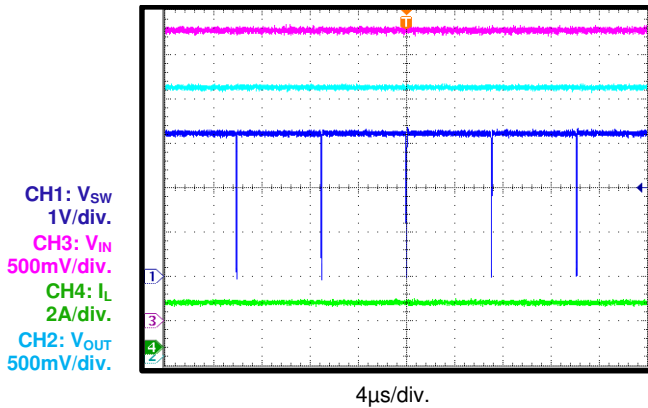

**Load Dump**

V<sub>IN</sub> = 12V to 36V, I<sub>OUT</sub> = 2A

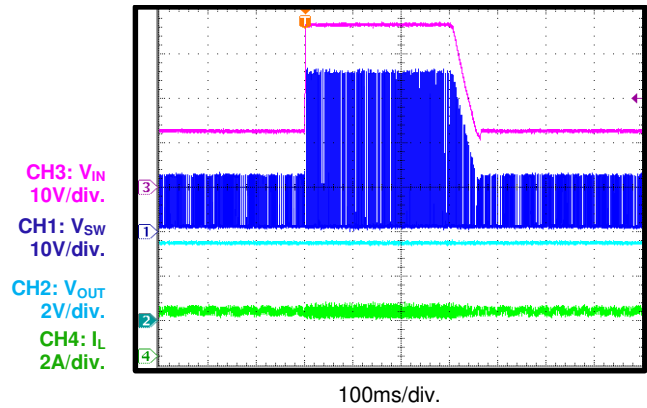

**Cold Crank**

V<sub>IN</sub> = 12V to 3.3V to 5V, I<sub>OUT</sub> = 2A

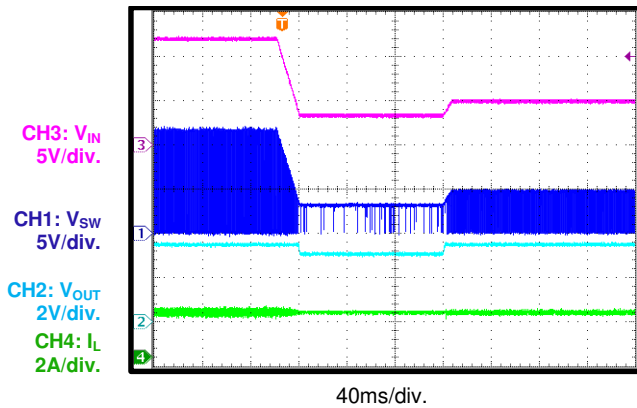

**V<sub>IN</sub> Ramps Up and Down**

I<sub>OUT</sub> = 0.1A

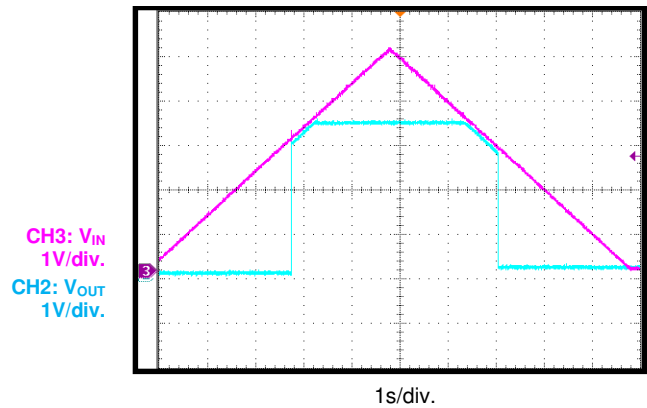

**TYPICAL PERFORMANCE CHARACTERISTICS** *(continued)*

V<sub>IN</sub> = 12V, V<sub>OUT</sub> = 3.3V, L = 5.6μH, f<sub>sw</sub> = 470kHz, AAM mode, T<sub>A</sub> = 25°C, unless otherwise noted.

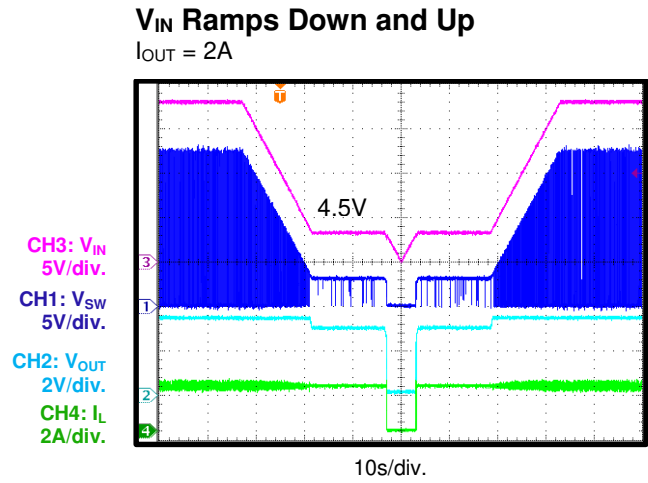
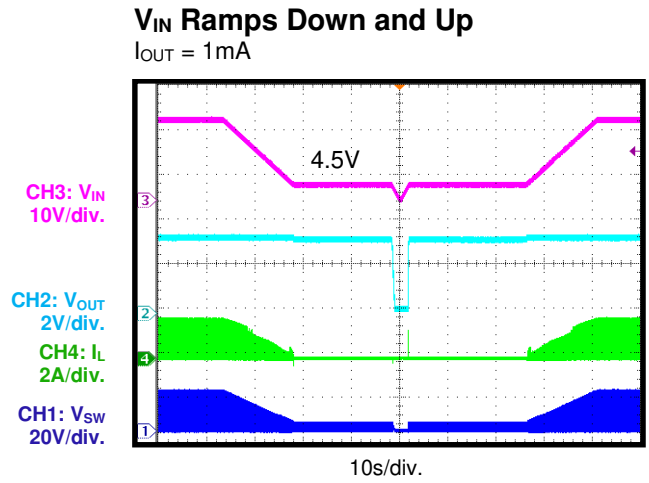



**FUNCTION BLOCK DIAGRAM**

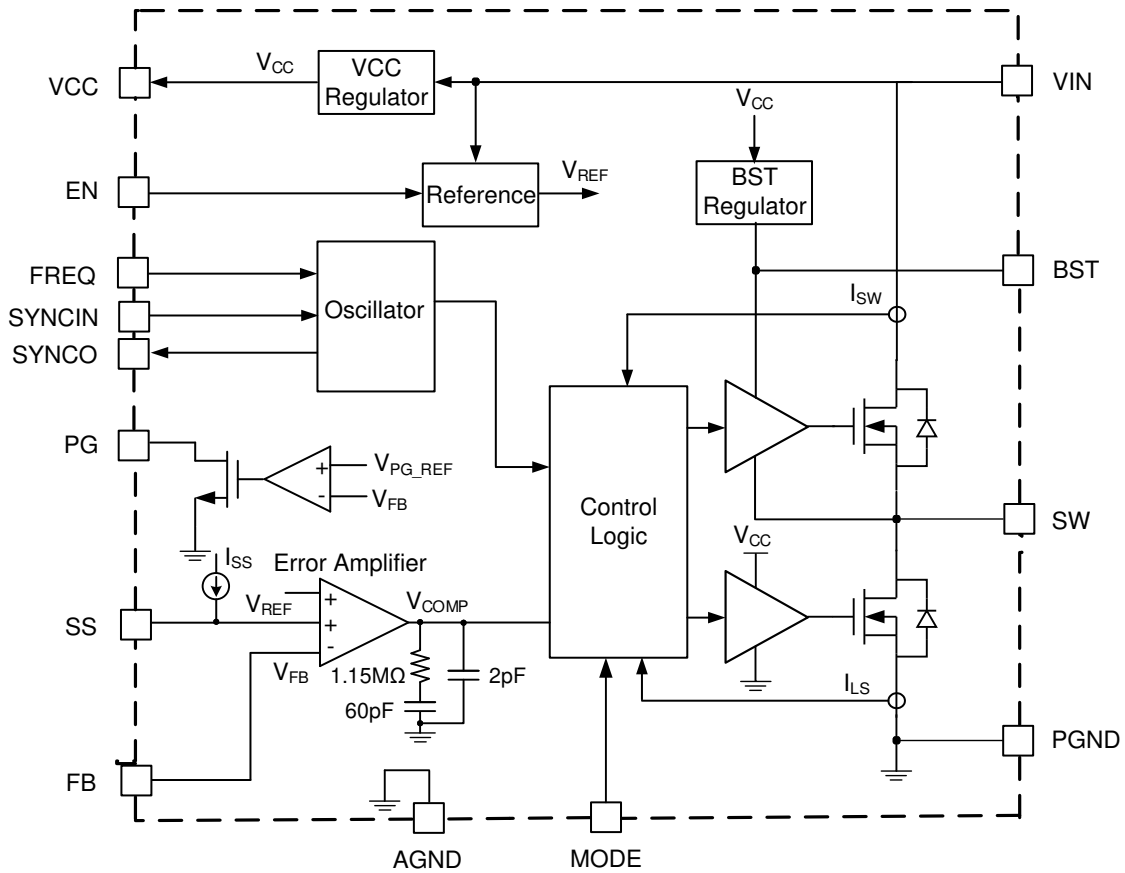

**Figure 1: Functional Block Diagram**

### TIMING SEQUENCE DIAGRAM

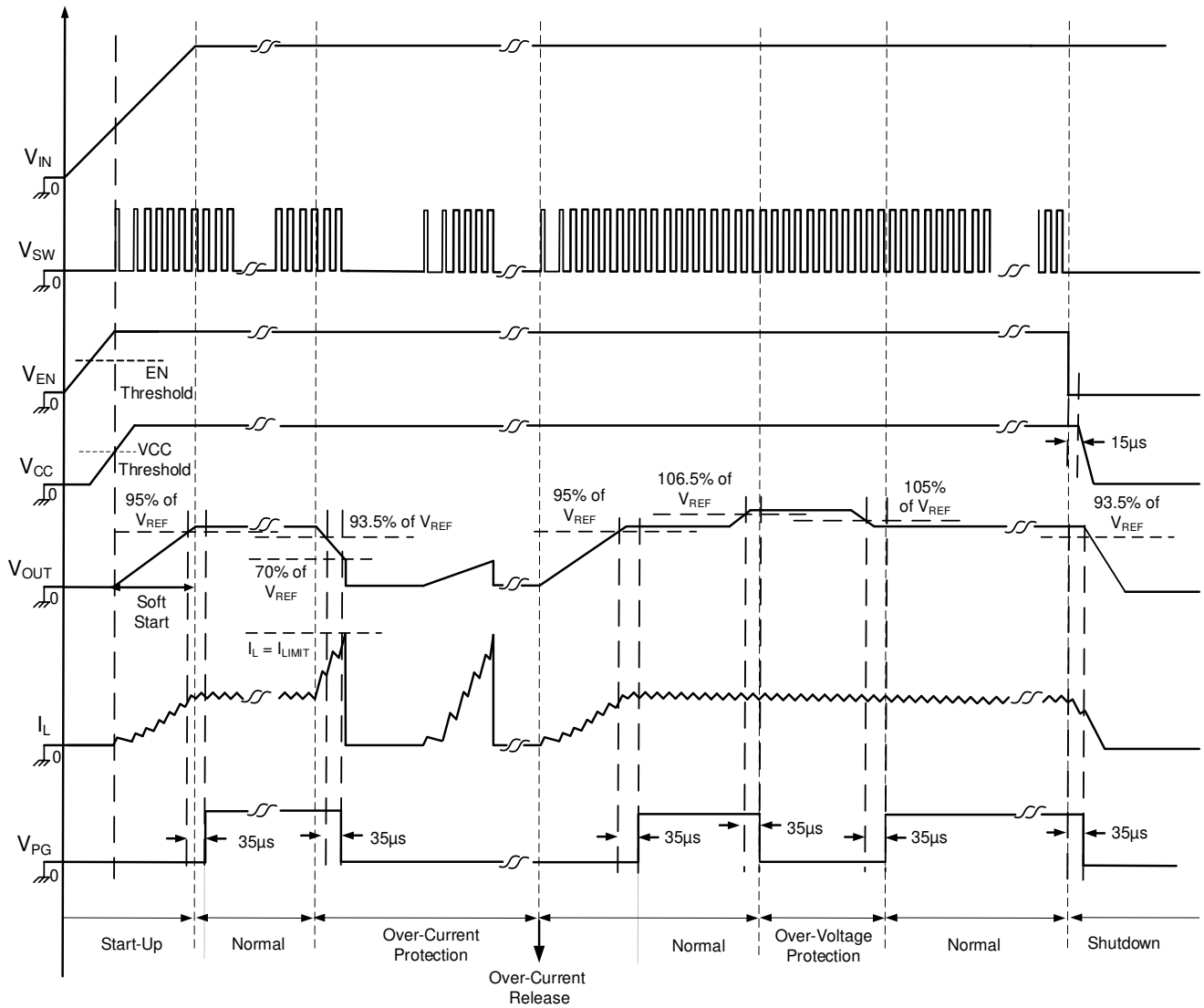

**Figure 2: Timing Sequence Diagram**

## OPERATION

The MP4312 is a synchronous, step-down switching converter with integrated internal power MOSFETs. It can achieve up to 2A of highly efficient, continuous output current ( $I_{OUT}$ ) with current mode control for fast loop response.

The device features a wide 3.3V to 45V input voltage ( $V_{IN}$ ) range, configurable switching frequency ( $f_{SW}$ ), external soft start (SS), and precision current limiting. Its low 1.7 $\mu$ A shutdown current ( $I_{SD}$ ) makes it well-suited for battery-powered applications.

### Pulse-Width Modulation (PWM) Mode Control

At moderate to high output currents, the MP4312 operates with fixed-frequency in peak current control mode to regulate the output voltage ( $V_{OUT}$ ). A pulse-width modulation (PWM) cycle is initiated by the internal clock. At the rising edge of the clock, the high-side power MOSFET (HS-FET) turns on and remains on until its current reaches the value set by the internal comparator ( $V_{COMP}$ ). The HS-FET remains on for a minimum of 100ns.

If the HS-FET is off, the low-side MOSFET (LS-FET) turns on and remains on until the next PWM cycle starts. The LS-FET remains on for a minimum of 80ns before the next cycle starts.

If the HS-FET current does not reach  $V_{COMP}$  within one PWM cycle, the HS-FET remains on to avoid shutting down the device. The HS-FET turns off after about 10 $\mu$ s, even if it has not reached  $V_{COMP}$ .

### Light-Load Operation

The MP4312 has a mode selection pin (MODE) that selects the IC's operation mode at light loads. Under light-load conditions, the device can operate in either forced continuous conduction mode (FCCM) or advanced asynchronous modulation (AAM) mode.

If MODE is pulled above 1.8V, then the MP4312 operates in FCCM. In FCCM, the part operates with a fixed frequency from no load to full loads. Advantages of FCCM include the controllable fixed frequency and lower  $V_{OUT}$  ripple ( $\Delta V_{OUT}$ ) under light-load conditions.

If MODE is pulled below 0.4V, then the MP4312 operates in AAM mode. AAM optimizes

efficiency under light-load and no-load conditions.

If AAM mode is enabled, then the MP4312 first enters asynchronous operation as the inductor current ( $I_L$ ) approaches 0A (see Figure 3). If the load decreases further or if there is no load,  $V_{COMP}$  drops to its set value and the device enters AAM mode.

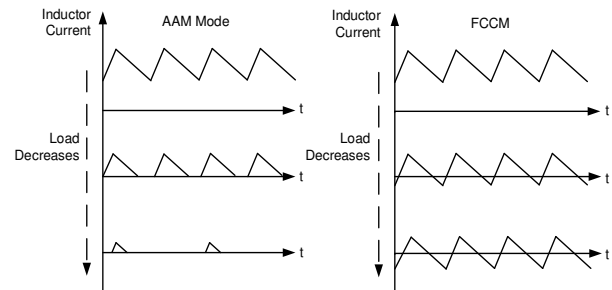

**Figure 3: AAM Mode and FCCM**

In AAM mode, the internal clock resets once  $V_{COMP}$  reaches its set value. The crossover time is used as the benchmark for the next clock. If the load increases and  $V_{COMP}$  exceeds its set value, then the device operates in discontinuous conduction mode (DCM) or FCCM, both of which have a constant  $f_{SW}$ .

### Error Amplifier (EA)

The error amplifier (EA) compares the FB pin voltage ( $V_{FB}$ ) to the internal reference voltage (0.815V), and outputs a current that is proportional to the difference between the voltages. This output current charges the compensation network to form  $V_{COMP}$ , which controls the power MOSFET current.

During normal operation, the minimum  $V_{COMP}$  is 0.9V, and the maximum is 2V. If the IC shuts down,  $V_{COMP}$  is pulled down to AGND internally.

### Internal Regulator (VCC)

The 4.9V internal regulator (VCC) powers most of the internal circuitry. The regulator uses the VIN pin as its input and operates across the entire  $V_{IN}$  range. If  $V_{IN}$  exceeds 4.9V, then VCC is in full regulation. If  $V_{IN}$  drops below 4.9V, then VCC's output degrades.

### Bootstrap (BST) Charging

The internal bootstrap (BST) regulator charges and regulates the BST capacitor ( $C_{BST}$ ) to about

5V. If the difference between the BST and SW pin voltages ( $V_{BST} - V_{SW}$ ) drops below 5V, then a P-channel MOSFET pass transistor connected between the VCC and BST pins turns on to charge  $C_{BST}$ . The external circuit should provide enough voltage headroom to facilitate charging. If the HS-FET turns on, then  $V_{BST}$  exceeds the VCC voltage ( $V_{CC}$ ) and  $C_{BST}$  cannot be charged.

At high duty cycles, there is less time to charge  $C_{BST}$ . This means that  $C_{BST}$  may not be charged sufficiently. If the external circuit has an insufficient voltage or not enough time to charge  $C_{BST}$ , then an additional external circuit is required to ensure that  $V_{BST}$  remains within its normal operation range.

**Low-Dropout Mode and BST Refresh**

To improve dropout, the MP4312 is designed to operate at close to 100% duty cycle while  $V_{BST} - V_{SW}$  is above 2.5V. If  $V_{BST} - V_{SW}$  drops below 2.5V, then the high side MOSFET is turned off via an under-voltage lockout (UVLO) circuit. This allows the LS-FET to conduct and refresh the charge on  $C_{BST}$ . In DCM or pulse-skip mode (PSM), the LS-FET is forced on to refresh  $V_{BST}$ .

Since the supply current sourced from  $C_{BST}$  is low, the HS-FET can remain on for more switching cycles than are required to refresh the capacitor. As a result, the effective duty cycle of the switching regulator is high.

The regulator’s effective duty cycle during dropout is mainly influenced by the voltage drops across the power MOSFET, the inductor resistance, the low-side diode, and the PCB resistance.

**Enable (EN) and Under-Voltage Lockout (UVLO) Protection**

The enable (EN) pin is a digital control pin that turns the converter on and off.

**Enable via External Logic High/Low Signal**

Pull EN above 1V to turn the converter on; pull EN below 0.85V to turn it off.

**Configurable  $V_{IN}$  UVLO Protection**

If  $V_{IN}$  exceeds the UVLO rising threshold, then the IC can be enabled and disabled via the EN pin. A configurable  $V_{IN}$  UVLO threshold and hysteresis can be generated with an internal current source. The EN voltage ( $V_{EN}$ ) can be set

via a resistor divider ( $R_{EN1} + R_{EN2}$ ) (see Figure 4).

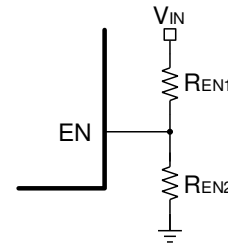

**Figure 4: Enable Divider Circuit**

**Configurable Switching Frequency ( $f_{sw}$ ) and Frequency Foldback**

$f_{sw}$  can be configured via an external resistor ( $R_{FREQ}$ ) connected between the FREQ pin and AGND, or by a logic-level SYNC signal.

See the  $f_{sw}$  vs.  $R_{FREQ}$  curves on page 15 to select  $R_{FREQ}$  and set  $f_{sw}$ . If  $f_{sw}$  is set high, it may fold back at high input voltages to avoid triggering the minimum on time ( $t_{ON\_MIN}$ ) and forcing the output out of regulation.

Set  $f_{sw}$  between 350kHz and 1000kHz for car battery applications. Table 1 lists the recommended  $R_{FREQ}$  values for common switching frequencies. High frequencies can be used in applications that do not require a critical  $f_{sw}$  limit or that have a low, stable  $V_{IN}$ .

**Table 1:  $R_{FREQ}$  vs.  $f_{sw}$**

$R_{FREQ}$ (k $\Omega$ )	$f_{sw}$ (kHz)
86.6	350
80.6	380
75	410
62	470
59	500
54.9	530
49.9	590
45.3	640
41.2	700
37.4	760
34	830
30.9	910
28.7	960
26.1	1000

**Frequency Spread Spectrum (FSS)**

The MP4312 employs a 12kHz modulation frequency and a fixed 128-step triangular profile to spread the internal  $f_{sw}$  across a 20% ( $\pm 10\%$ ) window (see Figure 5 on page 29). The steps are fixed and independent of the set  $f_{sw}$ . This

optimizes the frequency spread spectrum (FSS) performance.

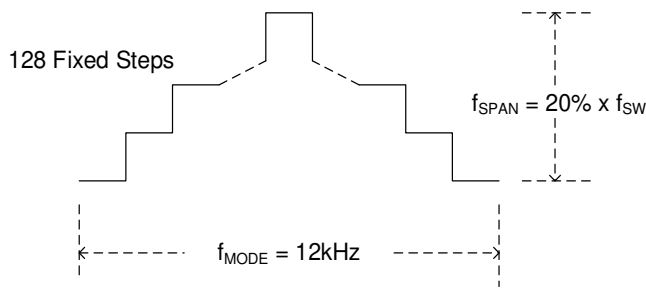

**Figure 5: Frequency Spread Spectrum**

Side bands are created by modulating  $f_{SW}$  via the triangle modulation waveform. This reduces the fundamental  $f_{SW}$  emission power and harmonics, which reduces noise caused by EMI.

### Soft Start (SS)

The MP4312 implements soft start (SS) to prevent  $V_{OUT}$  from overshooting during start-up.

Once SS is initiated, an internal current source charges the external soft-start capacitor ( $C_{SS}$ ). If the soft-start voltage ( $V_{SS}$ ) drops below  $V_{REF}$ , then  $V_{SS}$  overrides  $V_{REF}$  and the EA uses  $V_{SS}$  as the reference. If  $V_{SS}$  exceeds  $V_{REF}$ , then the EA uses  $V_{REF}$  as the reference.

The soft-start capacitance ( $C_{SS}$ ) can be calculated with Equation (1):

$$C_{SS}(\text{nF}) = \frac{t_{SS}(\text{ms}) \times I_{SS}(\mu\text{A})}{V_{REF}(\text{V})} = 13.5 \times t_{SS}(\text{ms}) \quad (1)$$

The SS pin can be used for tracking and sequencing.

### Pre-Bias Start-Up

If  $V_{FB}$  exceeds  $V_{SS} - 150\text{mV}$  during start-up, then the output has a pre-biased voltage. With a pre-biased voltage, the HS-FET and LS-FET do not turn on until  $V_{SS}$  exceeds  $V_{FB}$ .

### Thermal Shutdown

Thermal shutdown protects the IC from operating at exceedingly high temperatures (thermal runaway). If the silicon die temperature exceeds the thermal shutdown threshold (typically  $170^{\circ}\text{C}$ ), the device shuts down. Once the temperature drops below  $150^{\circ}\text{C}$ , the device initiates a SS and resumes normal operation.

### Current Comparator and Current Limit

The MOSFET currents are sensed via a current-sense MOSFET. This current is fed to the high-speed current comparator for current mode control. The current comparator uses this sensed current as one of its inputs.

If the HS-FET turns on, the comparator is blanked until the end of the turn-on period to mitigate noise. The comparator compares the MOSFET current to the set  $V_{COMP}$  value. If the sensed current exceeds  $V_{COMP}$ , then the comparator outputs low to turn off the HS-FET. The internal MOSFET maximum current is limited internally cycle by cycle.

### Output Over-Voltage Protection (OVP) with Hiccup Mode

If an output short to ground occurs,  $V_{OUT}$  may drop below 70% of its nominal value. If this occurs, the MP4312 shuts down to discharge  $C_{SS}$ . Once  $C_{SS}$  is discharged, the device initiates a SS to resume normal operation. This process repeats until the fault condition is removed.

### Start-Up and Shutdown

If both  $V_{IN}$  and  $V_{EN}$  exceed their respective thresholds, the MP4312 starts up. The reference block starts up first to generate a stable  $V_{REF}$  and currents. Then the internal regulator starts up to provide a stable supply for the remaining circuitries.

While the internal supply rail is up, an internal timer turns the HS-FET and LS-FET off for about  $50\mu\text{s}$  to blank any start-up glitches. Once the soft-start block is enabled, the device outputs low to ensure that the remaining circuitry is ready before slowly ramping up.

Three events can shut down the IC:  $V_{EN}$  going low,  $V_{IN}$  going low, and thermal shutdown. Once shutdown is initiated, the signaling path is blocked to avoid triggering any faults. Then  $V_{COMP}$  and the internal supply rail are pulled down. The floating driver is not subject to this shutdown command, but its charging path is disabled.

### Power Good (PG) Output

The power good (PG) pin is an open-drain output. If using the PG pin, connect it to a power source via a pull-up resistor. If  $V_{OUT}$  is between 95% and

105% of its nominal voltage, then PG is pulled high. If V<sub>OUT</sub> exceeds 106.5% or drops below 93.5% of its nominal voltage, then PG is pulled low.

### **SYNCIN and SYNCO**

f<sub>SW</sub> can be synchronized to the rising edge of the SYNCIN clock. It is recommended that the SYNCIN frequency (f<sub>SYNC</sub>) be between 350kHz and 1000kHz. SYNCIN's off time (t<sub>OFF</sub>) should be shorter than the internal oscillator period; otherwise, the internal clock may turn on the HS-FET before the rising edge of SYNCIN.

There is no limit for the SYNCIN pulse width, but there is always parasitic capacitance on the pad. If the pulse width is too short, a clear rising and

falling edge may not be achieved due to the parasitic capacitance. It is recommended to make the pulse longer than 100ns.

If using SYNCIN in AAM mode, pull SYNCIN below 0.4V or float SYNCIN before start-up. Then add the external SYNCIN clock. Connect a 10kΩ to 51kΩ resistor between SYNCIN and AGND to avoid floating SYNCIN.

The SYNCO pin provides a default 180° phase-shifted clock for the internal oscillator. If there is not an external SYNCIN clock, then SYNCO provides a 180° phase-shifted clock that is compared to the internal clock.

## APPLICATION INFORMATION

### Setting the Output Voltage

The external resistor divider connected to the FB pin sets V<sub>OUT</sub> (see Figure 6).

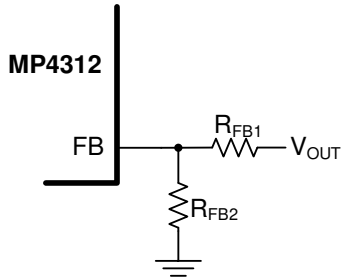

**Figure 6: Feedback Network**

The feedback resistance (R<sub>FB2</sub>) can be calculated with Equation (2):

$$R_{FB2} = \frac{R_{FB1}}{\frac{V_{OUT}}{0.815V} - 1} \quad (2)$$

Table 2 lists the recommended feedback resistor values for common output voltages.

**Table 2: Recommended Resistor Values for Common Output Voltages**

V <sub>OUT</sub> (V)	R <sub>FB1</sub> (kΩ)	R <sub>FB2</sub> (kΩ)
3.3	100 (1%)	32.4 (1%)
5	100 (1%)	19.6 (1%)

### Selecting the Input Capacitor (C<sub>IN</sub>)

The step-down converter has a discontinuous input current (I<sub>IN</sub>), and requires a capacitor to supply AC current to the converter while maintaining the DC V<sub>IN</sub>. For the best performance, use low-ESR capacitors. Ceramic capacitors with X5R or X7R dielectrics are highly recommended due to their low ESR and small temperature coefficients.

For most applications, a 4.7μF to 10μF capacitor is sufficient. It is strongly recommended to use another, lower-value capacitor (0.1μF) with a small package size (0603) to absorb high-frequency noise. Place the smaller capacitor as close to the VIN pin and PGND as possible.

Since the input capacitor (C<sub>IN</sub>) absorbs the input switching current, it requires an adequate ripple current rating. Estimate the RMS current in C<sub>IN</sub> (I<sub>CIN</sub>) with Equation (3):

$$I_{CIN} = I_{LOAD} \times \sqrt{\frac{V_{OUT}}{V_{IN}} \times \left(1 - \frac{V_{OUT}}{V_{IN}}\right)} \quad (3)$$

The worst-case condition occurs at V<sub>IN</sub> = 2 × V<sub>OUT</sub>, which can be calculated with Equation (4):

$$I_{CIN} = \frac{I_{LOAD}}{2} \quad (4)$$

For simplification, choose an input capacitor with an RMS current rating greater than half of the maximum load current (I<sub>LOAD\_MAX</sub>).

C<sub>IN</sub> can be electrolytic, tantalum, or ceramic. When using electrolytic or tantalum capacitors, place a small, high-quality ceramic capacitor (0.1μF) as close to the device as possible.

When using ceramic capacitors, ensure that they have enough capacitance to provide a sufficient charge to prevent an excessive voltage ripple at the input. The input voltage ripple (ΔV<sub>IN</sub>) caused by the capacitance can be estimated with Equation (5):

$$\Delta V_{IN} = \frac{I_{LOAD}}{f_{SW} \times C_{IN}} \times \frac{V_{OUT}}{V_{IN}} \times \left(1 - \frac{V_{OUT}}{V_{IN}}\right) \quad (5)$$

### Selecting the Output Capacitor (C<sub>OUT</sub>)

The output capacitor (C<sub>OUT</sub>) maintains the DC V<sub>OUT</sub>. Use ceramic, tantalum, or low-ESR electrolytic capacitors. Ceramic capacitors with low ESR are recommended for their small size and low output voltage ripple (ΔV<sub>OUT</sub>). ΔV<sub>OUT</sub> can be calculated with Equation (6):

$$\Delta V_{OUT} = \frac{V_{OUT}}{f_{SW} \times L} \times \left(1 - \frac{V_{OUT}}{V_{IN}}\right) \times \left(R_{ESR} + \frac{1}{8 \times f_{SW} \times C_{OUT}}\right) \quad (6)$$

Where L is the inductance, and R<sub>ESR</sub> is the equivalent series resistance of C<sub>OUT</sub>.

For ceramic capacitors, the capacitance dominates the impedance at f<sub>SW</sub> and causes the majority of ΔV<sub>OUT</sub>. For simplification, ΔV<sub>OUT</sub> can be estimated with Equation (7):

$$\Delta V_{OUT} = \frac{V_{OUT}}{8 \times f_{SW}^2 \times L \times C_{OUT}} \times \left(1 - \frac{V_{OUT}}{V_{IN}}\right) \quad (7)$$

For tantalum or electrolytic capacitors, the ESR dominates the impedance at f<sub>SW</sub>. For

simplification,  $\Delta V_{OUT}$  can be estimated with Equation (8):

$$\Delta V_{OUT} = \frac{V_{OUT}}{f_{SW} \times L} \times \left(1 - \frac{V_{OUT}}{V_{IN}}\right) \times R_{ESR} \quad (8)$$

The characteristics of  $C_{OUT}$  also affect the stability of the regulation system. The MP4312 can be optimized for a wide range of capacitances and ESR values.

### Selecting the Inductor

For most applications, a 1 $\mu$ H to 10 $\mu$ H inductor with a DC current rating of at least 25% greater than  $I_{LOAD\_MAX}$  is recommended. For higher efficiency, choose an inductor with a lower DC resistance. A larger-value inductor results in less ripple current and a lower  $\Delta V_{OUT}$ ; however, a larger-value inductor also has a larger physical size, higher series resistance, and lower saturation current. A good rule to determine the inductance is to allow the inductor ripple current ( $\Delta I_L$ ) to be approximately 30% of  $I_{LOAD\_MAX}$ . The inductance (L) can be calculated with Equation (9):

$$L = \frac{V_{OUT}}{f_{SW} \times \Delta I_L} \times \left(1 - \frac{V_{OUT}}{V_{IN}}\right) \quad (9)$$

Choose  $\Delta I_L$  to be about 30% of  $I_{LOAD\_MAX}$ . The maximum inductor peak current ( $I_{LP}$ ) can be calculated with Equation (10):

$$I_{LP} = I_{LOAD} + \frac{V_{OUT}}{2 \times f_{SW} \times L} \times \left(1 - \frac{V_{OUT}}{V_{IN}}\right) \quad (10)$$

### Setting the V<sub>IN</sub> Under-Voltage Lockout (UVLO) Threshold

The MP4312 has an internal fixed under-voltage lockout (UVLO) threshold. has an internal, fixed UVLO threshold. The rising threshold is 3V, and the falling threshold is about 2.7V. For applications that require a higher UVLO, place an external resistor divider between the VIN and EN pins to raise the UVLO threshold (see Figure 7).

The UVLO rising threshold ( $V_{IN\_UVLO\_RISING}$ ) can be calculated with Equation (11):

$$V_{IN\_UVLO\_RISING} = \left(1 + \frac{R_{UP}}{R_{DOWN}}\right) \times V_{EN\_RISING} \quad (11)$$

Where  $V_{EN\_RISING}$  is 1V.

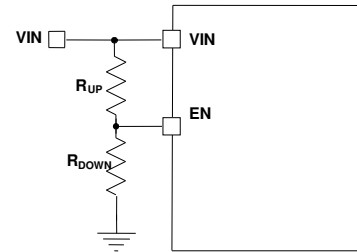

**Figure 7: Adjustable UVLO via the EN Divider**

The UVLO falling threshold ( $V_{IN\_UVLO\_FALLING}$ ) can be calculated with Equation (12):

$$V_{IN\_UVLO\_FALLING} = \left(1 + \frac{R_{UP}}{R_{DOWN}}\right) \times V_{EN\_FALLING} \quad (12)$$

Where  $V_{EN\_FALLING}$  is 0.85V.

### Selecting the External Bootstrap (BST) Diode and Resistor

An external BST diode can enhance the BST regulator’s efficiency during high duty cycles. A 2.5V to 5V power supply can be used to power the external BST diode. It is recommended to use  $V_{CC}$  or  $V_{OUT}$  as the power supply (see Figure 8).

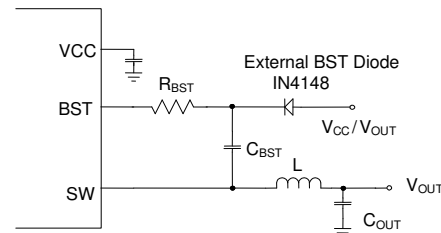

**Figure 8: Optional External BST Diode for Enhanced Efficiency**

It is recommended to use an IN4148 external BST diode. A resistor ( $R_{BST}$ ) in series with  $C_{BST}$  can reduce the  $V_{SW}$  rising slew rate and voltage spikes. This reduces EMI and voltage stress at a high input voltages. A higher resistance is better for SW spike reduction, but can compromise efficiency. To make a tradeoff between EMI and efficiency, it is recommended to keep  $R_{BST}$  below 20 $\Omega$ . The recommended  $C_{BST}$  value is 0.1 $\mu$ F to 1 $\mu$ F.

### Selecting the VCC Capacitor (C<sub>VCC</sub>)

The VCC capacitance ( $C_{VCC}$ ) should be 10 times  $C_{BST}$ .  $C_{VCC}$  should not exceed 68 $\mu$ F.



**PCB Layout Guidelines** <sup>(10)</sup>

Efficient PCB layout is critical for stable operation. It is recommended to use a 4-layer layout to improve thermal performance. For the best results, refer to Figure 9 and follow the guidelines below:

1. Place the symmetric input capacitors as close to VIN and PGND as possible.
2. Connect a large copper plane directly to PGND.
3. If the bottom PCB layer is the ground plane, place multiple vias near PGND.
4. Use short, direct, and wide traces for the high-current paths connected to VIN and PGND.
5. Place the input capacitor as close to the VIN and PGND pins as possible to minimize high-frequency noise. It is recommended that C<sub>IN</sub> be a ceramic bypass capacitor in a small 0603 package.
6. Keep the connection between the input capacitor and VIN as short and wide as possible.
7. Place the VCC capacitor as close to VCC and AGND as possible.
8. Route the SW and BST traces away from sensitive analog areas, such as FB.
9. Keep the FB trace as short and wide as possible by placing the FB resistors close to the IC.
10. Use multiple vias to connect the power planes and the internal layers.

**Note:**

10) The recommended PCB layout is based on Figure 10 on page 34.

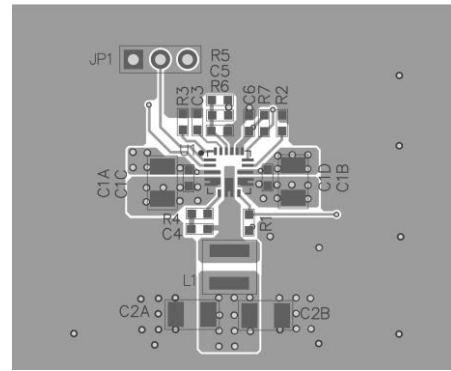

**Top Layer**

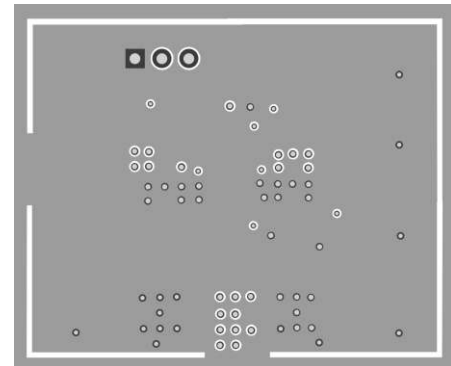

**Mid-Layer 1**

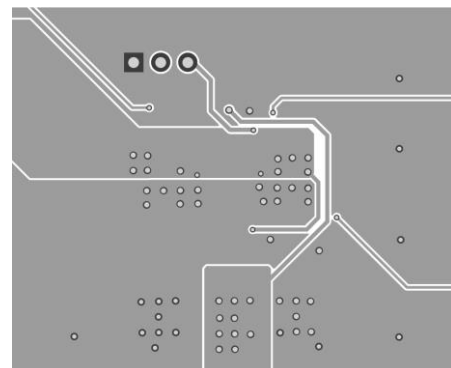

**Mid-Layer 2**

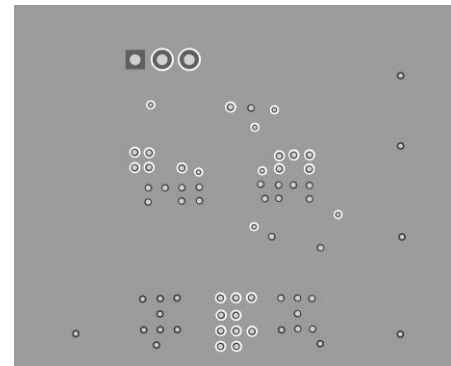

**Bottom Layer**

**Figure 9: Recommended PCB Layout**

**TYPICAL APPLICATION CIRCUITS**

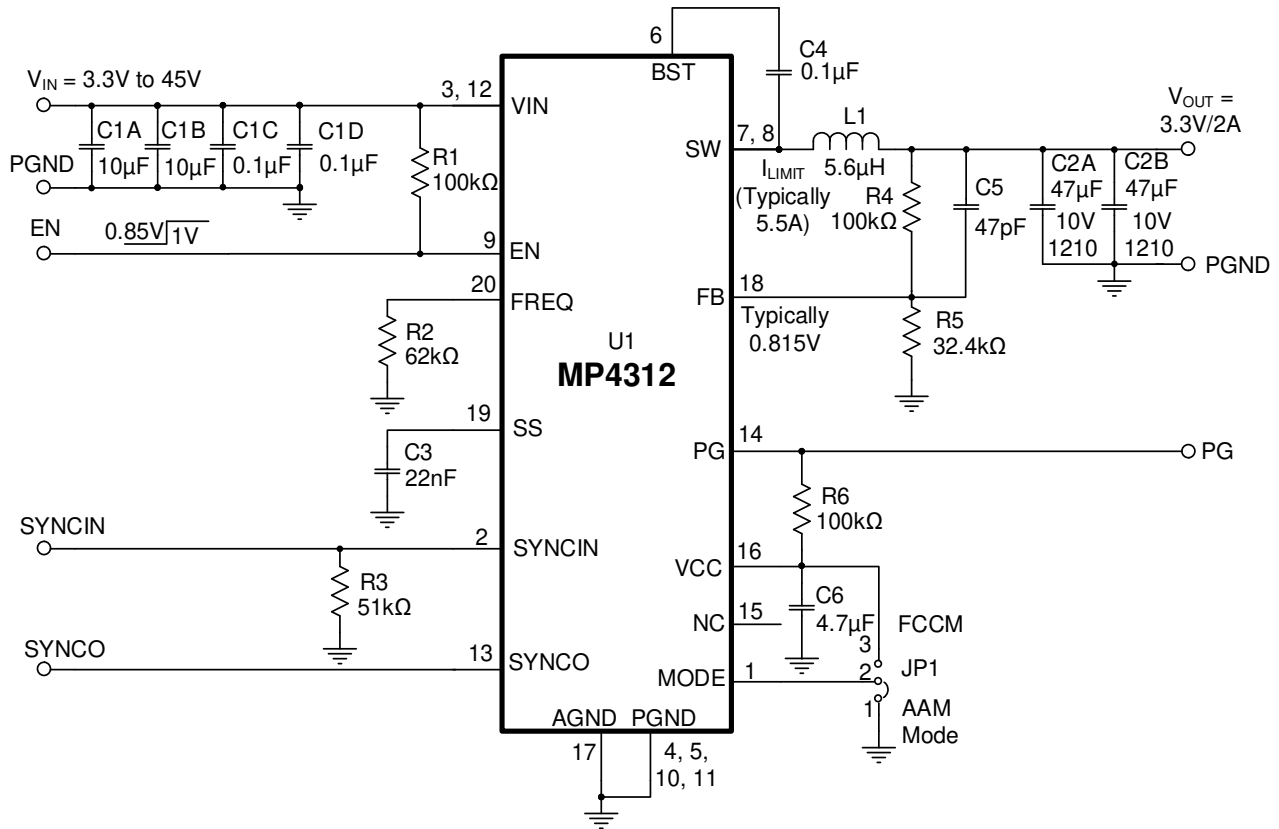

**Figure 10: Typical Application Circuit (V<sub>OUT</sub> = 3.3V, f<sub>sw</sub> = 470kHz)**

**TYPICAL APPLICATION CIRCUITS** (continued)

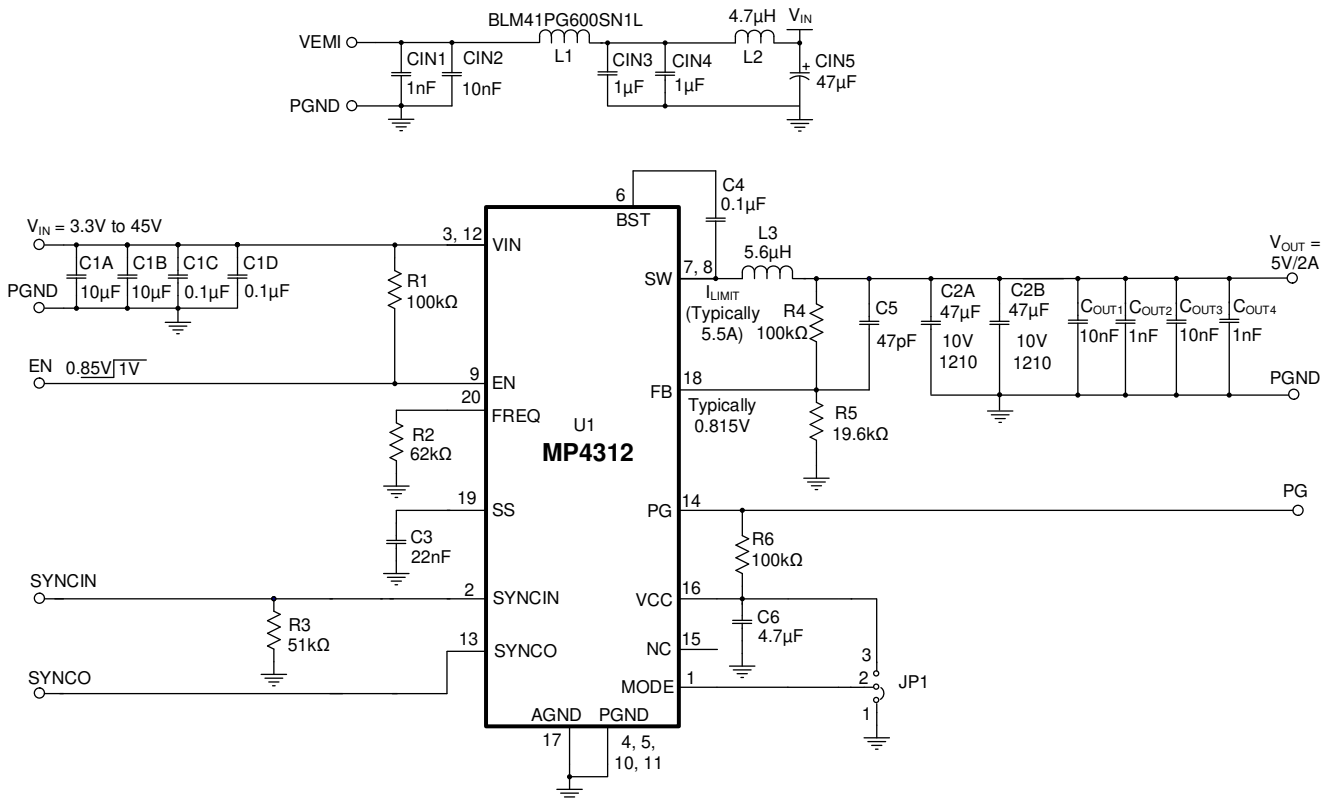

**Figure 11: Typical Application Circuit with EMI Filters (V<sub>OUT</sub> = 5V, f<sub>sw</sub> = 470kHz)**

**PACKAGE INFORMATION**

**QFN-20 (4mmx4mm)  
Wettable Flank**

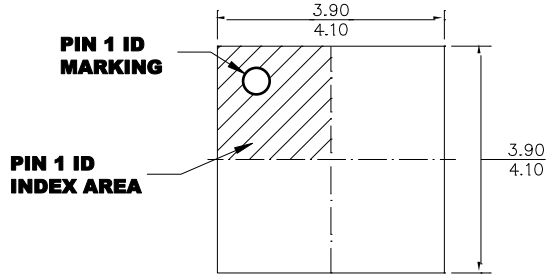

**TOP VIEW**

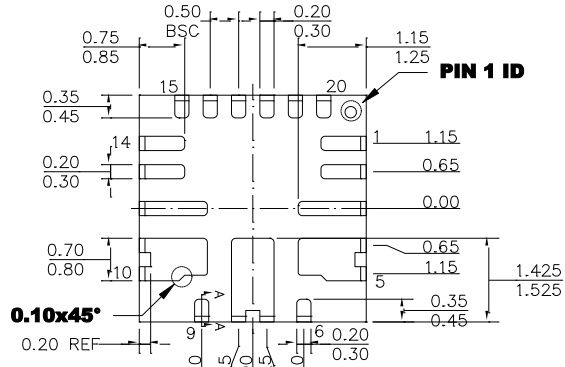

**BOTTOM VIEW**

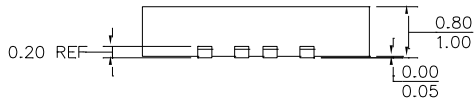

**SIDE VIEW**

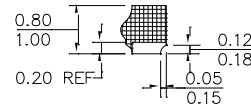

**SECTION A-A**

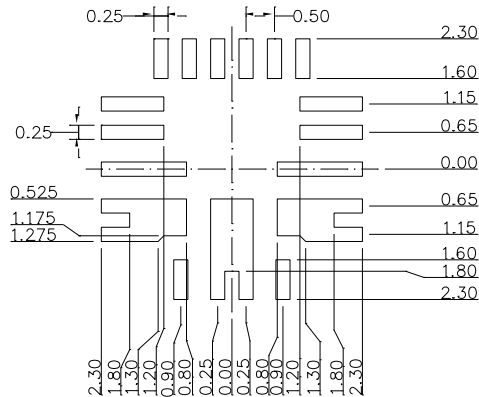

**RECOMMENDED LAND PATTERN**

**NOTE:**

- 1) THE LEAD SIDE IS WETTABLE.
- 2) ALL DIMENSIONS ARE IN MILLIMETERS.
- 3) LEAD COPLANARITY SHALL BE 0.08 MILLIMETERS MAX.
- 4) JEDEC REFERENCE IS MO-220.
- 5) DRAWING IS NOT TO SCALE.

**CARRIER INFORMATION**

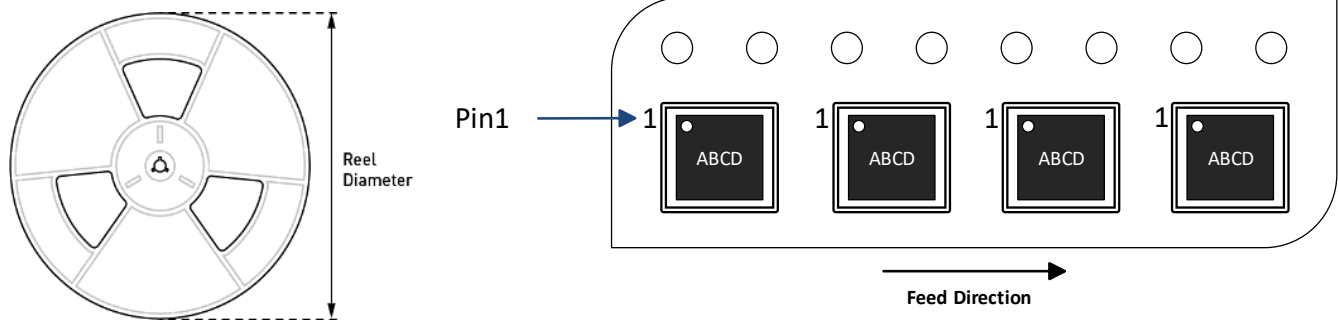

Part Number	Package Description	Quantity/ Reel	Quantity/ Tube <sup>(11)</sup>	Quantity/ Tray	Reel Diameter	Carrier Tape Width	Carrier Tape Pitch
MP4312GRE-Z	QFN-20 (4mmx4mm)	5000	N/A	N/A	13in	12mm	8mm

**Note:**

11) N/A indicates "not available" in tubes. For 500-piece tape & reel prototype quantities, contact MPS. (The order code for a 500-piece partial reel is "-P". Tape & reel dimensions are the same as for a full reel.)

## REVISION HISTORY

Revision #	Revision Date	Description	Pages Updated
1.0	2/10/2022	Initial Release	-

**Notice:** The information in this document is subject to change without notice. Please contact MPS for current specifications. Users should warrant and guarantee that third-party Intellectual Property rights are not infringed upon when integrating MPS products into any application. MPS will not assume any legal responsibility for any said applications.