

Power Relays

MK-S(X)

MK-S-series Relays with DC-switching Models That Can Switch 220 VDC, 10 A (Resistive Load).



- Switch a DC load of 220 VDC, 10 A (resistive load).
- Models for AC Loads can switch 250 VAC, 15 A (resistive load).
- Lineup includes models with SPST-NO and SPST-NO/SPST-NC contact forms.
- Using a SPST-NO/SPST-NC contact form enables detecting contact welding. (When the NO contacts become welded, the NC contacts will maintain a minimum distance of 0.5 mm.)
- Models available with operation indicators and built-in test buttons.
- RoHS compliant.
- Standards: UL, IEC (TÜV certification)



For the most recent information on models that have been certified for safety standards, refer to your OMRON website.

Ordering Information

When your order, specify the rated voltage.

General-purpose Relays Models for DC Loads

Type	Contact form	SPST-NO		SPST-NO/SPST-NC	
		Model	Rated voltage (V)	Model	Rated voltage (V)
Standard Models	MKS1XT-10	AC: 24, 100, 110, 120, 200, 220, 230, 240	DC: 12, 24, 48, 110, 220	MKS2XT-11	AC: 24, 100, 110, 120, 200, 220, 230, 240
		DC: 12, 24, 48, 110, 220			DC: 12, 24, 48, 110, 220
Models with Built-in Operation Indicators	MKS1XTN-10	AC: 24, 100, 110, 120, 200, 220, 230, 240	DC: 12, 24, 48, 110, 220	MKS2XTN-11	AC: 24, 100, 110, 120, 200, 220, 230, 240
		DC: 12, 24, 48, 110, 220			DC: 12, 24, 48, 110, 220
Models with Test Button	MKS1XTI-10	AC: 24, 100, 110, 120, 200, 220, 230, 240	DC: 12, 24, 48, 110, 220	MKS2XTI-11	AC: 24, 100, 110, 120, 200, 220, 230, 240
		DC: 12, 24, 48, 110, 220			DC: 12, 24, 48, 110, 220
Models with Test Button and Built-in Operation Indicators	MKS1XTIN-10	AC: 24, 100, 110, 120, 200, 220, 230, 240	DC: 12, 24, 48, 110, 220	MKS2XTIN-11	AC: 24, 100, 110, 120, 200, 220, 230, 240
		DC: 12, 24, 48, 110, 220			DC: 12, 24, 48, 110, 220

Models for AC Loads

Type	Contact form	SPST-NO		SPST-NO/SPST-NC	
		Model	Rated voltage (V)	Model	Rated voltage (V)
Standard Models	MKS1T-10	AC: 24, 100, 110, 120, 200, 220, 230, 240	DC: 12, 24, 48, 110, 220	MKS2T-11	AC: 24, 100, 110, 120, 200, 220, 230, 240
		DC: 12, 24, 48, 110, 220			DC: 12, 24, 48, 110, 220
Models with Built-in Operation Indicators	MKS1TN-10	AC: 24, 100, 110, 120, 200, 220, 230, 240	DC: 12, 24, 48, 110, 220	MKS2TN-11	AC: 24, 100, 110, 120, 200, 220, 230, 240
		DC: 12, 24, 48, 110, 220			DC: 12, 24, 48, 110, 220
Models with Test Button	MKS1TI-10	AC: 24, 100, 110, 120, 200, 220, 230, 240	DC: 12, 24, 48, 110, 220	MKS2TI-11	AC: 24, 100, 110, 120, 200, 220, 230, 240
		DC: 12, 24, 48, 110, 220			DC: 12, 24, 48, 110, 220
Models with Test Button and Built-in Operation Indicators	MKS1TIN-10	AC: 24, 100, 110, 120, 200, 220, 230, 240	DC: 12, 24, 48, 110, 220	MKS2TIN-11	AC: 24, 100, 110, 120, 200, 220, 230, 240
		DC: 12, 24, 48, 110, 220			DC: 12, 24, 48, 110, 220

Accessory (Order Separately)

Connecting Socket

Classifications		Built-in diode	Model
Back-connecting Socket	PCB Terminals	No	P7M-06P
Front-connecting Socket	Mounts to DIN Track or via screws	No	P7MF-06
		Yes	P7MF-06-D

MK-S(X)

Specifications

Ratings

Operating Coil

Item	Rated current (mA)		Coil resistance (Ω)	Must operate voltage (V)	Must release voltage (V)	Maximum voltage allowable (V)	Power consumption (VA, W)	
	50 Hz	60 Hz						
Rated voltage (V)				Percentage of rated voltage				
AC	24	110	96.3	80% max.	30% min. at 60 Hz 25% min. at 50 Hz	110%	Approx. 2.3 VA at 60 Hz Approx. 2.7 VA at 50 Hz	
	100	26.6	23.1					48.4
	110	24.2	21.0					760
	120	22.2	19.3					932
	200	13.3	11.6					1,130
	220	12.1	10.5					3,160
	230	11.5	10.0					4,250
240	11.0	9.6	4,480					
DC	12	126		15% min.			Approx. 1.5 W	
	24	63.2						
	48	32.0						
	110	13.6						
	220	6.8						

- Note:**
1. The rated current and coil resistance are measured at a coil temperature of 23°C with tolerances of +15%/–20% for AC rated current and ±15% for DC coil resistance.
 2. Performance characteristic data are measured at a coil temperature of 23°C.
 3. The maximum allowable voltage is the maximum value of the allowable voltage range for the operating power supply for the relay coil. There is no continuous allowance.
 4. The rated current is approximately 5 mA higher for Models with Built-in Operation Indicators (DC operating coils).

Contact Ratings for Models for DC Loads

Item		Contact form		SPST-NO			SPST-NO/SPST-NC		
		Model	Load	MKS1T(I)(N)-10			MKS2T(I)(N)-11		
				Resistive load	Inductive load		Resistive load	Inductive load	
		L/R = 7 ms	DC13 class			L/R = 7 ms		DC13 class	
Contact configuration	NO	Double-break			Double-break				
	NC	---			Single-break				
Contact material		AgSnIn			AgSnIn				
Rated load	NO	10 A, 220 VDC	5 A, 220 VDC	0.4 A, 220 VDC	5 A, 220 VDC	3 A, 220 VDC	0.2 A, 220 VDC		
	NC	---			2 A, 220 VDC	0.3 A, 220 VDC	0.1 A, 220 VDC		
Rated carry current	NO	10 A			5 A				
	NC	---			2 A				
Max. switching voltage	NO	220 VDC			220 VDC				
	NC	---							
Max. switching current	NO	10 A	5 A	0.4 A	5 A	3 A	0.2 A		
	NC	---			2 A	0.3 A	0.1 A		
Max. switching capacity (reference value)	NO	2,200 W	---	---	1,100 W	---	---		
	NC	---			440 W	---	---		

Note: If the L/R of an inductive load exceeds 7 ms with a Model for a DC Load, the arc interruption time must be less than approximately 50 ms to use the Relay. Design the circuit so that the arc interruption time is 50 ms or less.

* These values apply to a switching frequency of 30 times per minute.

Contact Ratings for Models for AC Loads

Item		Contact form		SPST-NO	SPST-NO/SPST-NC
		Model	Load	MKS1T(I)(N)-10	MKS2T(I)(N)-11
				Resistive load	Resistive load
Contact configuration	NO	Double-break		Double-break	
	NC	---		Single-break	
Contact material		AgSnIn		AgSnIn	
Rated load	NO	15 A, 250 VAC		15 A, 250 VAC	
	NC	---		5 A, 250 VAC	
Rated carry current	NO	15 A		15 A	
	NC	---		5 A	
Max. switching voltage	NO	250 VAC		250 VAC	
	NC	---			
Max. switching current	NO	15 A		15 A	
	NC	---		5 A	
Max. switching capacity (reference value)	NO	3,750 VA		3,750 VA	
	NC	---		1,250 VA	

* These values apply to a switching frequency of 20 times per minute.

Characteristics

Contact resistance *1		100 mΩ max.
Operate time *2		AC: 20 ms max. DC: 30 ms max.
Release time *2		20 ms max.
Max. operating frequency	Mechanical	18,000 operations/h
	Rated load	Models for DC loads: 1,800 times/hour Models for AC loads: 1,200 times/hour
Insulation resistance *3		100 MΩ min.
Dielectric strength	Between coil and contacts	2,500 VAC 50/60 Hz for 1 min between
	Between contacts of different polarity	2,500 VAC 50/60 Hz for 1 min between
	Between contacts of same polarity	1,000 VAC 50/60 Hz for 1 min
Vibration resistance	Destruction	10 to 55 to 10 Hz, 0.75-mm single amplitude (1.5-mm double amplitude)
	Malfunction	10 to 55 to 10 Hz, 0.50-mm single amplitude (1.0-mm double amplitude)
Shock resistance	Destruction	Back-connecting Socket (P7M-06P) mounting: 1,000 m/s ² Front-connecting Socket (P7MF-06(-D)) mounting: 500m/s ²
	Malfunction	100 m/s ²
Endurance	Mechanical	1,000,000 operations min. (at 18,000 operations/hr)
	Electrical *4	100,000 operations min. (at rated load and maximum switching frequency)
Failure rate P level (reference value)		10 mA at 24 VDC
Ambient operating temperature		-40°C to 60°C (with no icing or condensation) Note: The range is -25°C to 60°C for models with built-in operation indicators.
Ambient operating humidity		5% to 85%
Weight		SPST-NO: Approx. 73 g, SPST-NO/SPST-NC: Approx. 82 g

Note: The values given above are initial values.

*1. The contact resistance was measured for 1 A at 5 VDC using the voltage drop method.

*2. The operate time was measured with the rated voltage imposed and any contact bounce ignored at an ambient temperature of 23°C.

*3. The insulation resistance was measured with a 500-VDC insulation resistance tester at the same places as those used for checking the dielectric strength.

*4. The electrical endurance was measured at an ambient temperature of 23°C.

Approved Standards

UL508 (File No. E41515)  

Model	Coil ratings	Contact ratings	Operations
MKS1XT□-□	12 to 220 VDC 24 to 240 VAC	NO contacts 10 A, 220 VDC (Resistive) 5 A, 220 VDC L/R (T _{0.632}) = 7 ms 0.4 A, 220 VDC L/R (T _{0.95}) = 300 ms	6,000
MKS2XT□-□		NO contacts 5 A, 220 VDC (Resistive) 3 A, 220 VDC L/R (T _{0.632}) = 7 ms 0.2 A, 220 VDC L/R (T _{0.95}) = 300 ms	
		NC contacts 2 A, 220 VDC (Resistive) 0.3 A, 220 VDC L/R (T _{0.632}) = 7 ms 0.1 A, 220 VDC L/R (T _{0.95}) = 300 ms	
MKS1T□-□		NO contacts 15 A, 250 VAC (Resistive)	
MKS2T□-□		NO contacts 15 A, 250 VAC (Resistive)	
		NC contacts 5 A, 250 VAC (Resistive)	

CSA Standard: CSA Certification by  : CSA C22.2 No.14

IEC Standard/TÜV Certification: IEC61810-1 (Certification No. R50104853) 

Model	Coil ratings	Contact ratings	Operations
MKS1XT□-□	12, 24, 48, 110, 220 VDC 24, 100, 110, 120, 200, 220, 230, 240 VAC	NO contacts DC-1: 10 A, 220 VDC 5 A, 220 VDC L/R (T _{0.632}) = 7 ms DC-13: 0.4 A, 220 VDC	100,000
MKS2XT□-□		NO contacts DC-1: 5 A, 220 VDC 3 A, 220 VDC L/R (T _{0.632}) = 7 ms DC-13: 0.2 A, 220 VDC	
		NC contacts DC-1: 2 A, 220 VDC 0.3 A, 220 VDC L/R (T _{0.632}) = 7 ms DC-13: 0.1 A, 220 VDC	
MKS1T□-□		NO contacts AC-1: 15 A, 250 VAC 50/60 Hz	
MKS2T□-□		NO contacts AC-1: 15 A, 250 VAC 50/60 Hz	
		NC contacts AC-1: 5 A, 250 VAC 50/60 Hz	

Engineering Data

Maximum Switching Power

**MKS1XT-10, MKS1XTN-10
MKS1XTI-10, MKS1XTIN-10**

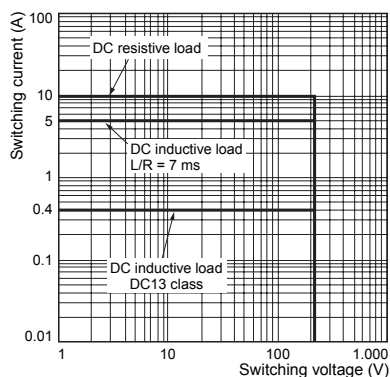

**MKS1T-10, MKS1TN-10
MKS1TI-10, MKS1TIN-10**

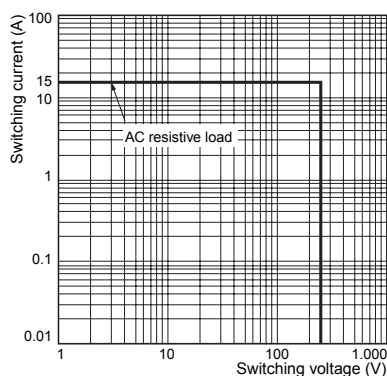

**MKS2XT-11, MKS2XTN-11
MKS2XTI-11, MKS2XTIN-11**

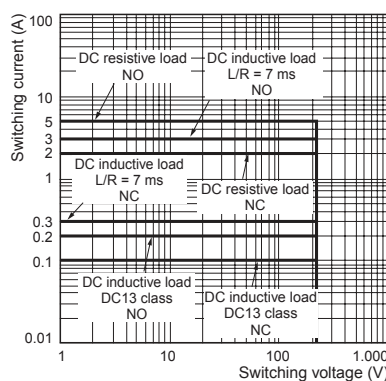

**MKS2T-11, MKS2TN-11
MKS2TI-11, MKS2TIN-11**

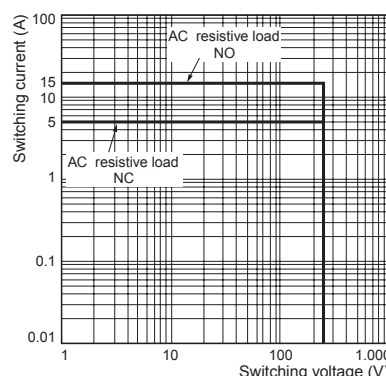

Ambient Temperature vs. Must Operate Voltage and Must Release Voltage

**MKS2XT-11
AC Specification (60 Hz)**

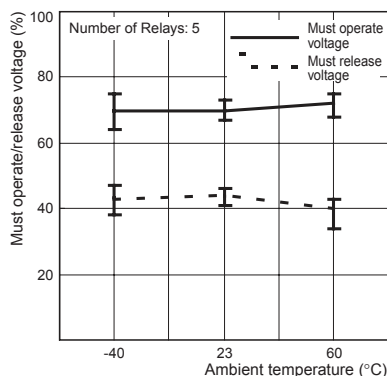

**MKS2XT-11
DC Specification**

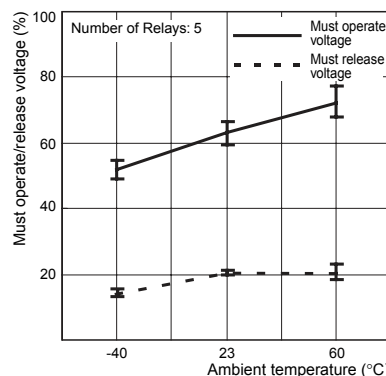

Inductive Load Switching Power (Models for DC Loads)

**MKS1XT-10, MKS1XTN-10
MKS1XTI-10, MKS1XTIN-10**

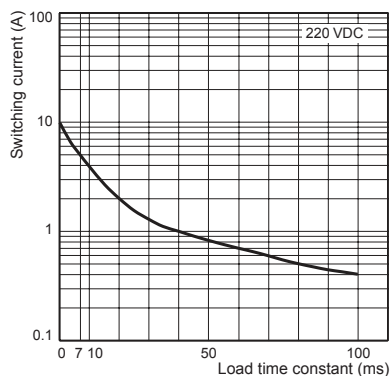

**MKS2XT-11, MKS2XTN-11
MKS2XTI-11, MKS2XTIN-11**

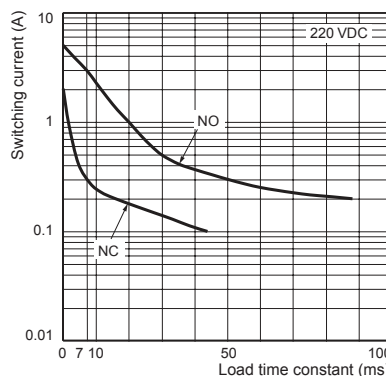

MK-S(X)

Test Button

The circuit can be checked using either of two modes.

Test Button
DC specification: Blue
AC specification: Red



Normal

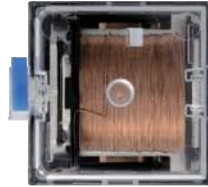

Mode 1
(momentary)



Press the button
for operation.
(No tool is required.)

Mode 2
(locked)

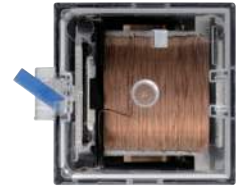

Lock the contacts by
pressing down on the
button and turning it.

Test Button Applications

Example: Checking operation of Relays and sequence circuits.

Dimensions

General-purpose Relays

Models for DC Loads

Standard Models

MKS1XT-10 MKS2XT-11

Models with Built-in Operation Indicators

MKS1XTN-10 MKS2XTN-11

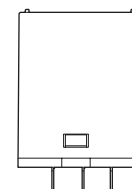
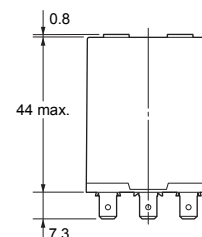
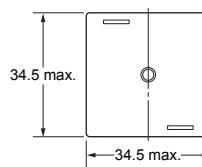

Models for AC Loads

Standard Models

MKS1T-10 MKS2T-11

Models with Built-in Operation Indicators

MKS1TN-10 MKS2TN-11

Models for DC Loads

Models with Test Button

MKS1XTI-10 MKS2XTI-11

Models with Test Button and Built-in Operation Indicators

MKS1XTIN-10 MKS2XTIN-11

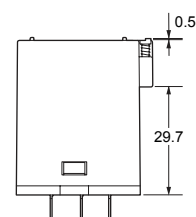
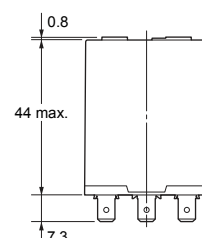
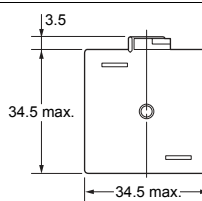

Models for AC Loads

Models with Test Button

MKS1TI-10 MKS2TI-11

Models with Test Button and Built-in Operation Indicators

MKS1TIN-10 MKS2TIN-11

Terminal Arrangement/Internal Connection (Bottom View)

MKS1XT-10 MKS1XTI-10	MKS1XTN-10 MKS1XTIN-10	MKS2XT-11 MKS2XTI-11	MKS2XTN-11 MKS2XTIN-11
	DC specification	AC specification	
	DC specification	AC specification	

Note: 1. Wire properly using the correct coil polarity.
 2. The contact terminals on Models for DC Loads have polarity. Wire properly using the correct polarity.

MK-S(X)

Connecting Socket

Back-connecting Socket

P7M-06P

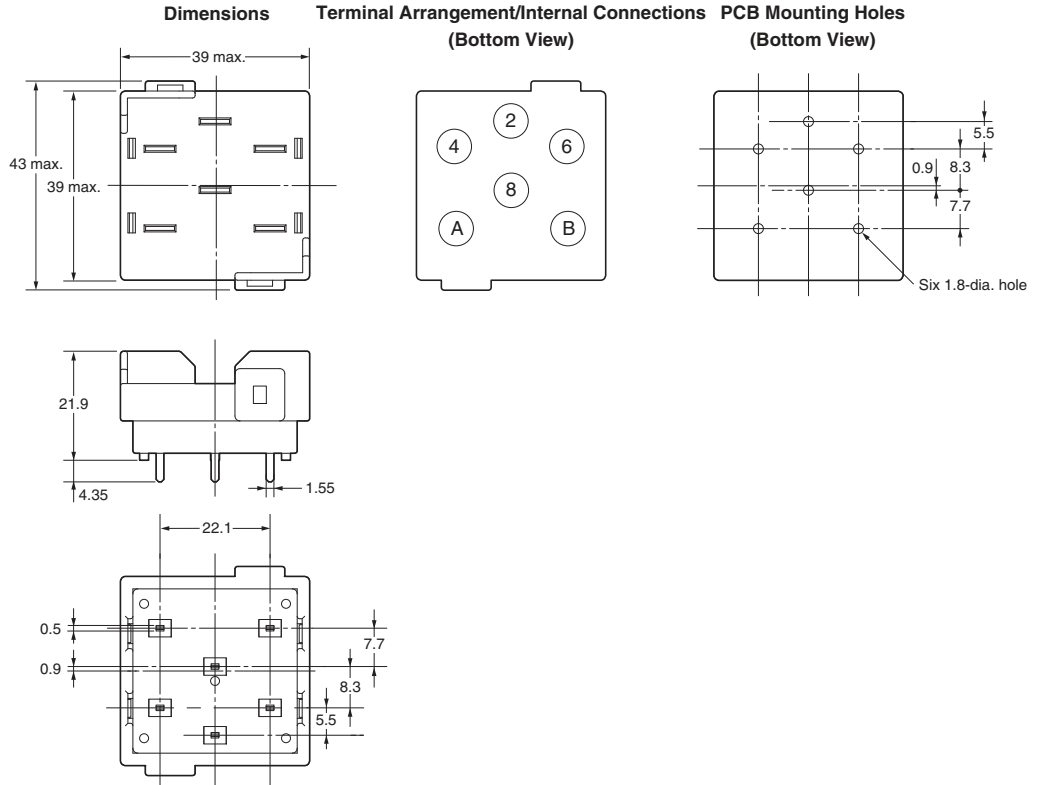
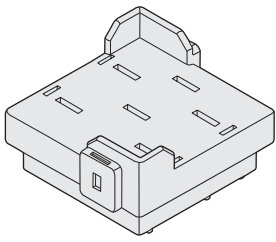

Front-connecting Socket

P7MF-06

P7MF-06-D

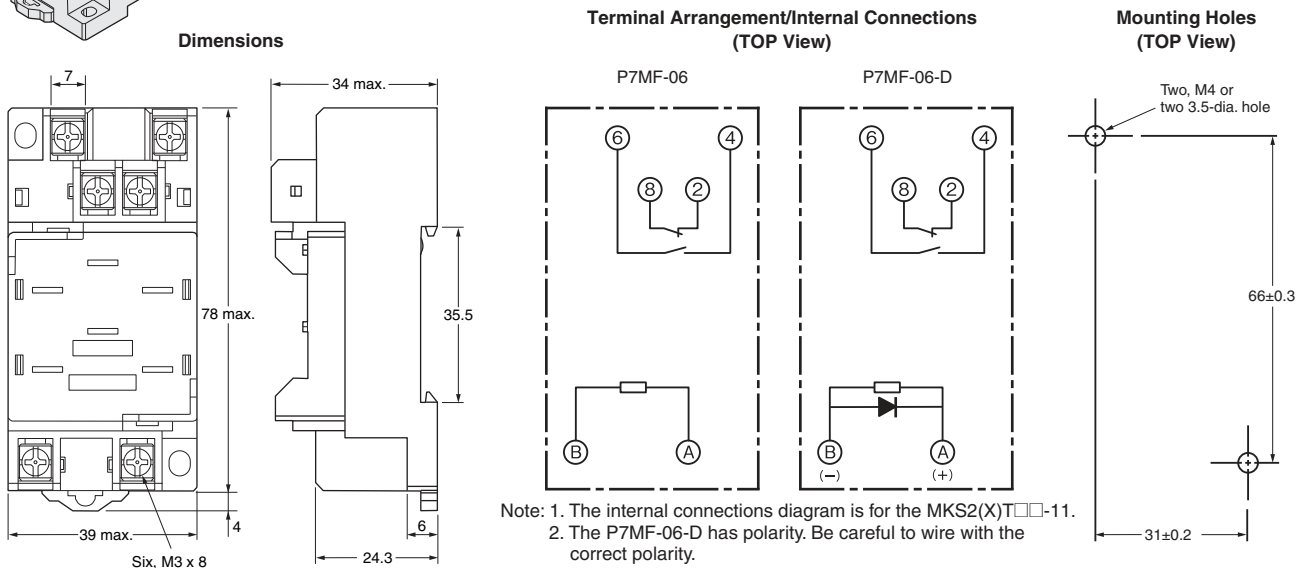
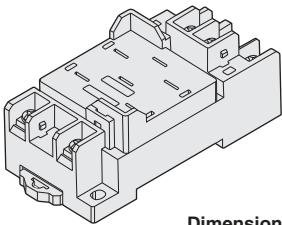

Accessory (Order Separately) Connecting Socket

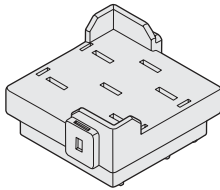
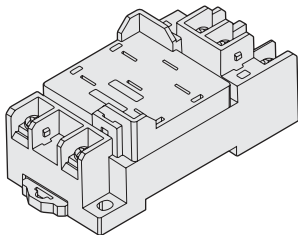
Socket	Back-connecting Socket	Front-connecting Socket
Number of poles	PCB terminals	Mounts to DIN Track or via screws
2	<p>P7M-06P</p> 	<p>P7MF-06 P7MF-06-D</p> 

- Note:**
1. The P7M-06P, P7MF-06, and P7MF-06-D can be used with models for DC loads with an SPST-NO or SPST-NO/SPST-NC contact form or with models for AC loads with an SPST-NO or SPST-NO/SPST-NC contact form.
 2. The P7MF-06-D has a built-in diode and can thus be used only with Relays with DC operating coils. Do not use it with a Relay with an AC operating coil.
 3. Refer to *Gang Mounting* on page 10 for the conditions required for gang mounting.

Relay Hold-down Clips

Use the Clips to securely mount the Relay and prevent it from falling due to vibration or shock.

Applicable Relay models		
Socket	<p>MKS1XT-10 MKS1XTI-10 MKS1XTIN-10 MKS1XTN-10 MKS1T-10 MKS1TI-10 MKS1TIN-10 MKS1TN-10</p>	<p>MKS2XT-11 MKS2XTI-11 MKS2XTIN-11 MKS2XTN-11 MKS2T-11 MKS2TI-11 MKS2TIN-11 MKS2TN-11</p>
Back-connecting Socket	PCB terminals	P7M-06P
Front-connecting Socket	Mounts to DIN Track or via screws	P7MF-06
		P7MF-06-D
PYC-A2		

PYC-A2 One Set (Two Clips)

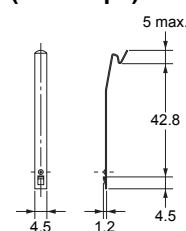

Note: The minimum order for the PYC-A2 is ten clips.

Socket Mounting Height

P7M-06P

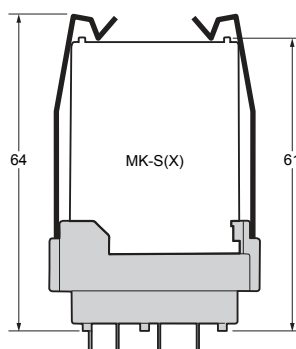
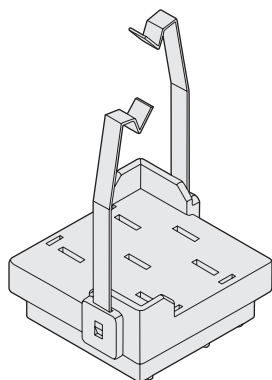

P7MF-06 P7MF-06-D

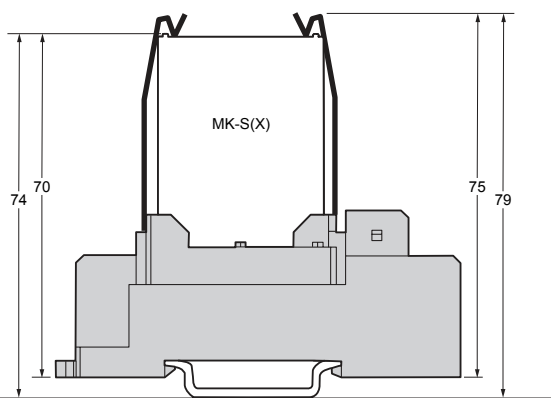
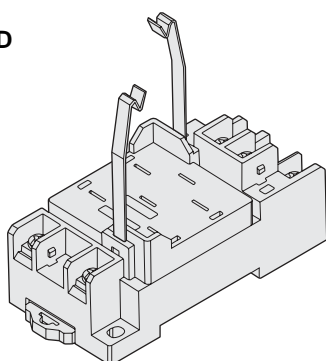

MK-S(X)

Safety Precautions

Refer also to *Precautions for All Relays*.

Precautions for Correct Use

Installation

- Models for DC loads (i.e., models with "X" in the model number) have permanent magnets built into the insulating block. If a permanent magnet or other magnetic body comes near the Relay, magnetic interference will occur with the built-in permanent magnet and the contact switching capacity will be decreased.
- Models for AC loads do not contain a permanent magnet.
- When mounting a P7MF-06(-D) Front-mounting Socket to a DIN Track, attach PFP-M End Plates on both sides of the Socket to prevent it from moving.

Gang Mounting

Conditions for Gang Mounting Relays

Relay	Rated current of Relay	Socket	
		Back-Connecting Socket	Front-Connecting Socket
Models for DC Loads	10A	○	○
Models for AC Loads	15A	○	*

* Gang mounting of the Front-Mounting Sockets is not possible if the contact carry current exceeds 10A. Provide space on both the right and left sides of the Sockets.

The mounting pitch is given in the following diagram.

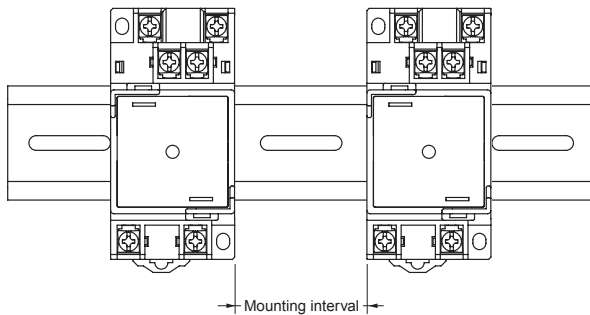
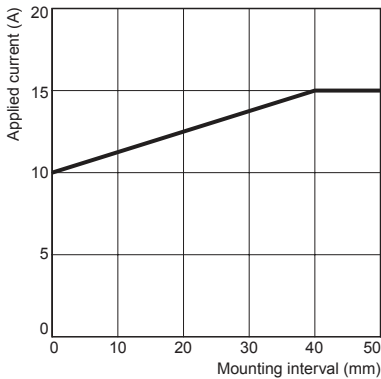

Wiring

- The contact terminals on Models for DC Loads (i.e., models with "X" in the model number) have polarity. Wiring with incorrect polarity may result in inability to turn OFF the Relay or loss of functionality.
- Wire models with built-in operation indicators with the correct coil polarity (DC operating coil).

Test Button

- Turn OFF the power supply before operating the test button. Always return the test button to the original position after you use it.
- Do not use the test button as a switch.
- The durability of the test button is 100 operations minimum.

Operating Environment

Do not use the Relay in environments with combustible gas. Doing so may result in explosion due to arcing.

Storage

Models for DC Loads (i.e., models with "X" in the model number) are magnetized because they have a built-in magnet to deflect and extinguish the arc. Do not install the Relay near IC cards or other items that may be adversely affected by magnetism.

Usage

Use the Relay mounted in the P7M-06P or P7MF-06(-D) Socket.

Warranty and Application Considerations

Read and Understand this Catalog

Please read and understand this catalog before purchasing the products. Please consult your OMRON representative if you have any questions or comments.

Warranty and Limitations of Liability

WARRANTY

OMRON's exclusive warranty is that the products are free from defects in materials and workmanship for a period of one year (or other period if specified) from date of sale by OMRON.

OMRON MAKES NO WARRANTY OR REPRESENTATION, EXPRESS OR IMPLIED, REGARDING NON-INFRINGEMENT, MERCHANTABILITY, OR FITNESS FOR PARTICULAR PURPOSE OF THE PRODUCTS. ANY BUYER OR USER ACKNOWLEDGES THAT THE BUYER OR USER ALONE HAS DETERMINED THAT THE PRODUCTS WILL SUITABLY MEET THE REQUIREMENTS OF THEIR INTENDED USE. OMRON DISCLAIMS ALL OTHER WARRANTIES, EXPRESS OR IMPLIED.

LIMITATIONS OF LIABILITY

OMRON SHALL NOT BE RESPONSIBLE FOR SPECIAL, INDIRECT, OR CONSEQUENTIAL DAMAGES, LOSS OF PROFITS, OR COMMERCIAL LOSS IN ANY WAY CONNECTED WITH THE PRODUCTS, WHETHER SUCH CLAIM IS BASED ON CONTRACT, WARRANTY, NEGLIGENCE, OR STRICT LIABILITY.

In no event shall the responsibility of OMRON for any act exceed the individual price of the product on which liability is asserted.

IN NO EVENT SHALL OMRON BE RESPONSIBLE FOR WARRANTY, REPAIR, OR OTHER CLAIMS REGARDING THE PRODUCTS UNLESS OMRON'S ANALYSIS CONFIRMS THAT THE PRODUCTS WERE PROPERLY HANDLED, STORED, INSTALLED, AND MAINTAINED AND NOT SUBJECT TO CONTAMINATION, ABUSE, MISUSE, OR INAPPROPRIATE MODIFICATION OR REPAIR.

Application Considerations

SUITABILITY FOR USE

OMRON shall not be responsible for conformity with any standards, codes, or regulations that apply to the combination of products in the customer's application or use of the products.

Take all necessary steps to determine the suitability of the product for the systems, machines, and equipment with which it will be used.

Know and observe all prohibitions of use applicable to this product.

NEVER USE THE PRODUCTS FOR AN APPLICATION INVOLVING SERIOUS RISK TO LIFE OR PROPERTY WITHOUT ENSURING THAT THE SYSTEM AS A WHOLE HAS BEEN DESIGNED TO ADDRESS THE RISKS, AND THAT THE OMRON PRODUCTS ARE PROPERLY RATED AND INSTALLED FOR THE INTENDED USE WITHIN THE OVERALL EQUIPMENT OR SYSTEM.

Disclaimers

PERFORMANCE DATA

Performance data given in this catalog is provided as a guide for the user in determining suitability and does not constitute a warranty. It may represent the result of OMRON's test conditions, and the users must correlate it to actual application requirements. Actual performance is subject to the OMRON *Warranty and Limitations of Liability*.

CHANGE IN SPECIFICATIONS

Product specifications and accessories may be changed at any time based on improvements and other reasons. Consult with your OMRON representative at any time to confirm actual specifications of purchased product.

DIMENSIONS AND WEIGHTS

Dimensions and weights are nominal and are not to be used for manufacturing purposes, even when tolerances are shown.

OMRON Corporation
Industrial Automation Company

Control Devices Division H.Q.
Strategy Planning Division
Shiokoji Horikawa, Shimogyo-ku,
Kyoto, 600-8530 Japan
Tel: (81) 75-344-7109/Fax: (81) 75-344-7149

Regional Headquarters
OMRON EUROPE B.V.
Wegalaan 67-69-2132 JD Hoofddorp
The Netherlands
Tel: (31)2356-81-300/Fax: (31)2356-81-388
OMRON Industrial Automation Global: www.ia.omron.com

OMRON ELECTRONICS LLC
One Commerce Drive Schaumburg,
IL 60173-5302 U.S.A.
Tel: (1) 847-843-7900/Fax: (1) 847-843-7787

OMRON ASIA PACIFIC PTE. LTD.
No. 438A Alexandra Road # 05-05/08 (Lobby 2),
Alexandra Technopark, Singapore 119967
Tel: (65) 6835-3011/Fax: (65) 6835-2711

OMRON (CHINA) CO., LTD.
Room 2211, Bank of China Tower,
200 Yin Cheng Zhong Road,
PuDong New Area, Shanghai, 200120, China
Tel: (86) 21-5037-2222/Fax: (86) 21-5037-2200

Authorized Distributor:

© OMRON Corporation 2008-2020 All Rights Reserved.
In the interest of product improvement,
specifications are subject to change without notice.

CSM_5_3
Cat. No. J175-E1-03

Printed in Japan
0520(0809)