

1

2

3

4

5

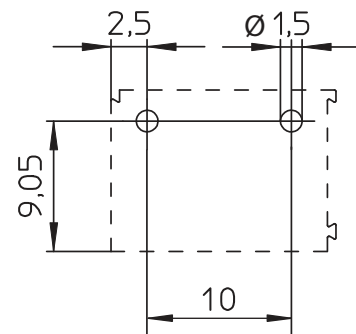
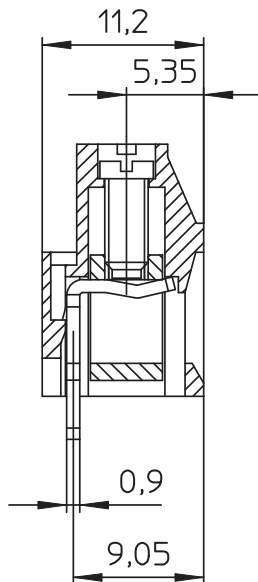
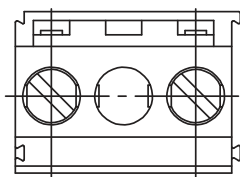
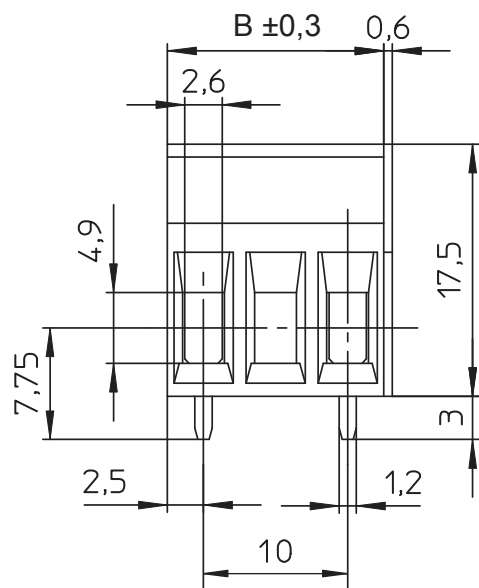

PCB LAYOUT - COMPONENT VIEW

$$B = (\text{nb. pin} \times \text{pitch}) - 5$$

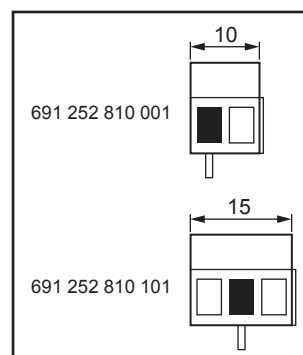

## TECHNICAL CHARACTERISTICS

MATERIAL  
 INSULATOR: PA6/66  
 FLAMMABILITY RATING: UL94V0  
 COLOR: GREEN  
 METAL HOUSING: COPPER ALLOY / Ni+Sn  
 TERMINAL SCREW: STEEL / Zn  
 WIRE GUARD: COPPER ALLOY / Ni+Sn

ENVIRONMENTAL  
 OPERATING TEMPERATURE: -30°C UP TO +120°C  
 COMPLIANCE: LEAD FREE AND ROHS

ELECTRICAL	UL	VDE
CURRENT RATING:	16 A	24 A
WORKING VOLTAGE:	300 VAC	750 VAC
WITHSTANDING VOLTAGE:	1,6 KV	3 KV
CONTACT RESISTANCE:	20 mΩ MAX	

## STANDARD

CERTIFIED: E150931 CAT. N°: MRT4 (1)  
 CERTIFIED: 40021393 TYPE: MRT4

## MECHANICAL

SOLID WIRE: 30-12 AWG / 0,05-3,31 (x2) mm<sup>2</sup>  
 STRANDED WIRE: 30-12 AWG / 0,05-3,31 (x2) mm<sup>2</sup>  
 TORQUE: 5 Lb.In / 0,5 Nm

WIRE STRIPE LENGTH: 6 mm  
 SCREW: M3  
 PITCH: 10 mm

SOLDERING  
 JEDEC LEAD FREE WAVE SOLDERING

PACKAGING  
 BOX

RoHS Compliant

PROJECTION:



GENERAL TOLERANCE

±0,1



APPROVAL: FBr

UNIT: MM

SCALE:

SHEET: 1/2

DRAW: AK

DESCRIPTION: SERIE 2528 - 10.00 MM - HORIZONTAL CABLE ENTRY WITH RISING CAGE CLAMP - WR-TBL

WERI PART NO: 691 252 810 0xx

SIZE

A4

REV	DATE	FILE	BY
B	01-SEP-15	ADD VIEW	AK
A	22-JUN-15	PDF	AK

1

2

3

4

5

## Cautions and Warnings:

This electronic component is designed and developed with the intention for use in general electronics equipments.

Before incorporating the components into any equipments in the field such as aerospace, aviation, nuclear control, submarine, transportation, (automotive control, train control, ship control), transportation signal, disaster prevention, medical, public information network etc. where higher safety and reliability are especially required or if there is possibility of direct damage or injury to human body, Würth Elektronik must be asked for a written approval.



In addition, even electronic component in general electronic equipments, when used in electrical circuits that require high safety, reliability functions or performance, the sufficient reliability evaluation-check for the safety must be performed before by the user before usage.

A

B

C

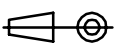
RoHS Compliant

G				PROJECTION: 	GENERAL TOLERANCE .X = +/- 0.2 .XX = +/- 0.15		
F							
E							
D							
C				APPROVAL: JC	UNIT: MM	DESCRIPTION: DISCLAIMER	SIZE <b>A4</b>
B					SCALE:		
A	10-SEP-14	PDF	QL		SHEET: 2/2	WERI PART NO: DISCLAIMER	
REV	DATE	FILE	BY		DRAW: QL		

D