

2SC3857

Silicon NPN Triple Diffused Planar Transistor (Complement to type 2SA1493)

Application : Audio and General Purpose

Absolute maximum ratings (Ta=25°C)

Symbol	Ratings	Unit
V _{CB0}	200	V
V _{CEO}	200	V
V _{EB0}	6	V
I _c	15	A
I _B	5	A
P _c	150(T _c =25°C)	W
T _j	150	°C
T _{stg}	-55 to +150	°C

Electrical Characteristics (Ta=25°C)

Symbol	Conditions	Ratings	Unit
I _{CB0}	V _{CB} =200V	100max	μA
I _{EB0}	V _{EB} =6V	100max	μA
V _{(BR)CEO}	I _c =50mA	200min	V
h _{FE}	V _{CE} =4V, I _c =5A	50min*	
V _{CE(sat)}	I _c =10A, I _B =1A	3.0max	V
f _r	V _{CE} =12V, I _E =-0.5A	20typ	MHz
C _{OB}	V _{CB} =10V, f=1MHz	250typ	pF

*h_{FE} Rank ○(50 to 100), P(70 to 140), Y(90 to 180)

Typical Switching Characteristics (Common Emitter)

V _{CC} (V)	R _L (Ω)	I _c (A)	V _{BB1} (V)	V _{BB2} (V)	I _{B1} (A)	I _{B2} (A)	t _{on} (μs)	t _{stg} (μs)	t _f (μs)
60	12	5	10	-5	0.5	-0.5	0.3typ	2.4typ	0.4typ

External Dimensions MT-200

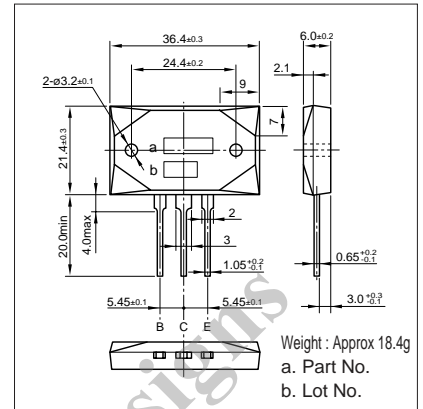

I_c-V_{CE} Characteristics (Typical)

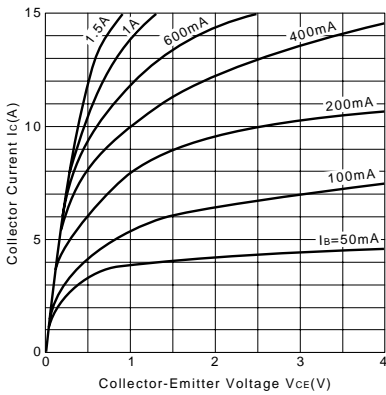

V_{CE(sat)}-I_B Characteristics (Typical)

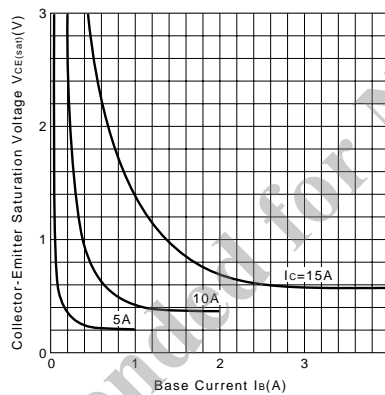

I_c-V_{BE} Temperature Characteristics (Typical)

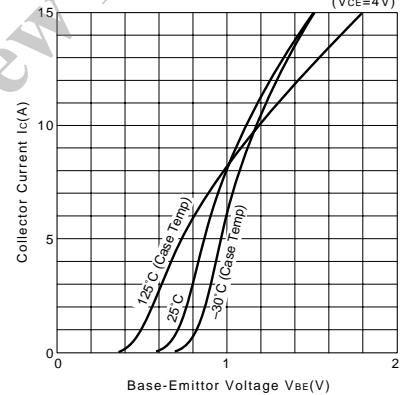

h_{FE}-I_c Characteristics (Typical)

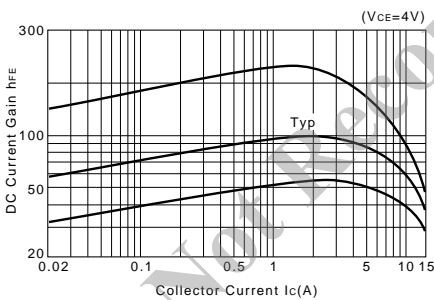

h_{FE}-I_c Temperature Characteristics (Typical)

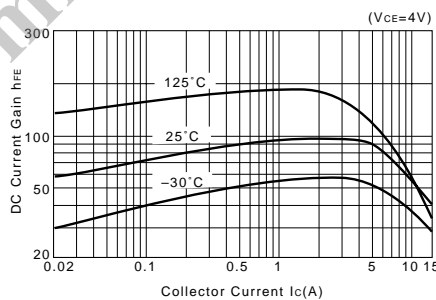

θ_{j-a}-t Characteristics

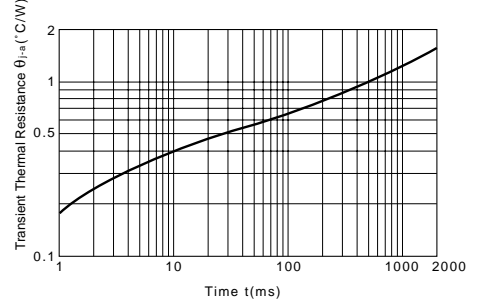

f_r-I_E Characteristics (Typical)

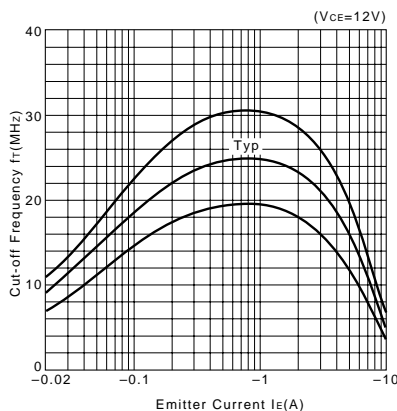

Safe Operating Area (Single Pulse)

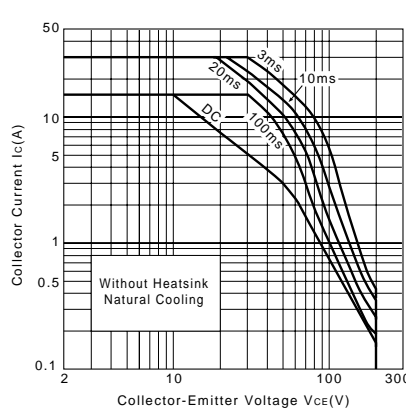

P_c-T_a Derating

