

CPDQ3V3-HF

RoHS Device
Halogen Free

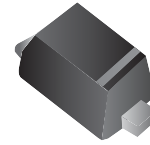

Features

- IEC61000-4-2 Level 4 ESD protection.
- ESD Rating of Class 3 per Human Body Mode.
- Peak Power up to 150 Watts @ 8x20µs Pulse.
- Low Leakage current.
- Response Time is Typically <1ns
- Working Voltage: 3.3V

Mechanical data

- Case: 0402/SOD-923F small outline plastic package.
- Terminals: Matte tin plated, solderable per MIL-STD-750, method 2026.
- Mounting position: Any.
- High temperature soldering guaranteed: 260°C/10 second.
- Weight: 0.001 grams(approx.).

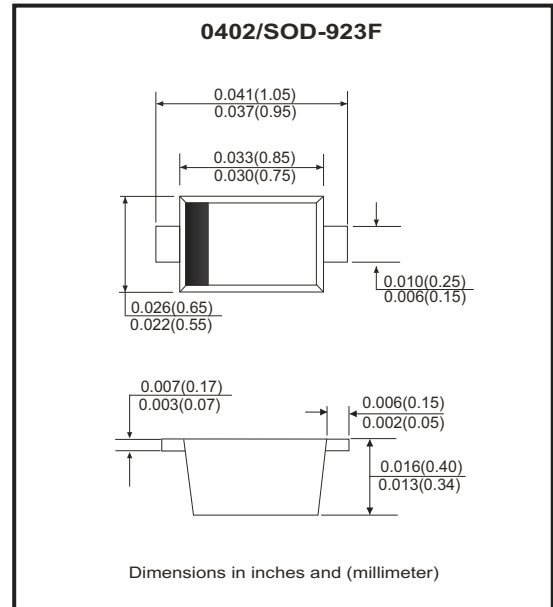

Circuit Diagram

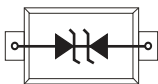

Maximum Rating (at TA=25°C unless otherwise noted)

Parameter	Conditions	Symbol	Value	Unit
Peak pulse power	T _P = 8/20 us	PPP	158	W
Peak pulse current	T _P = 8/20 us	I _{PP}	11.2	A
ESD capability	IEC 61000-4-2(Air)	ESD	±15	kV
	IEC 61000-4-2(Contact)	ESD	±8	kV
Junction temperature rang		T _J	150	°C
Operating temperature rang		T _{OP}	-40 to +125	°C
Storage temperature rang		T _{STG}	-55 to +150	°C

Electrical Characteristics

(Ratings at $T_A=25^{\circ}\text{C}$ ambient temperature unless otherwise specified. $V_F=0.9\text{V}$ at $I_F=10\text{mA}$)

Parameter	Conditions	Symbol	Min	Typ	Max	Unit
Reverse stand-off voltage		V_{RWM}			3.3	V
Reverse leakage current	$V_R = 3.3\text{ V}$	I_R			1	μA
Reverse breakdown voltage	$I_R = 1\text{ mA}$	V_{BR}	5			V
Clamping voltage	$I_{PP} = 5\text{ A}$, $t_p = 8/20\mu\text{s}$	V_C			8.4	V
	$I_{PP} = 11.2\text{ A}$, $t_p = 8/20\mu\text{s}$	V_C			14.1	V
Junction capacitance	$V_R = 0\text{ V}$, $F = 1\text{ MHz}$	C_J		25		pF

NOTES:

- V_{BR} is measured with a pulse test current I_T at an ambient temperature of 25°C .

RATING AND CHARACTERISTIC CURVES (CPDQ3V3-HF)

Fig.1 - Pulse Waveform

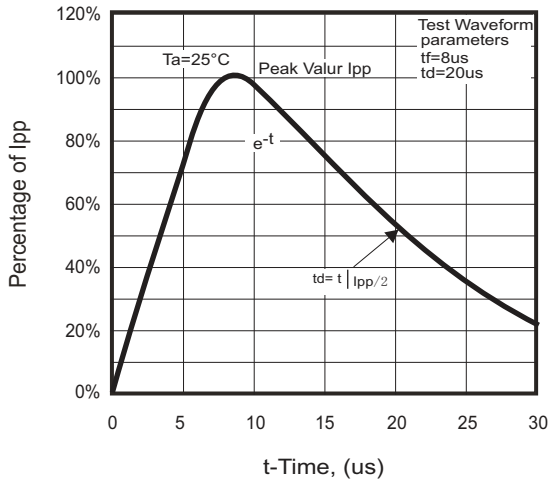
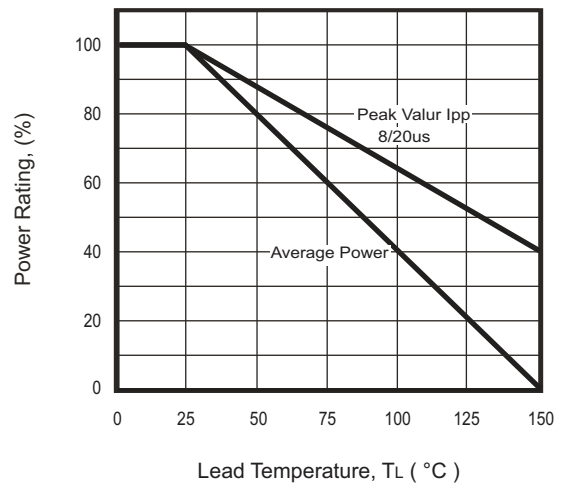
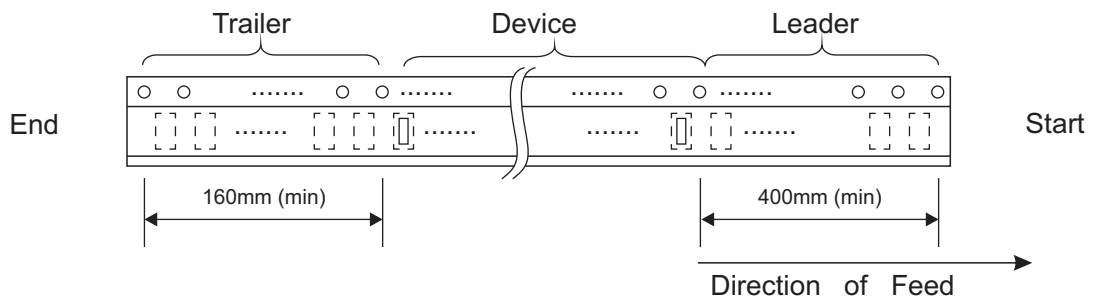
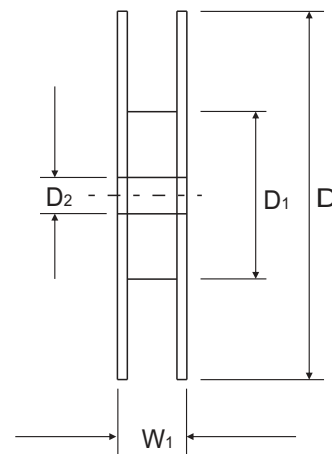
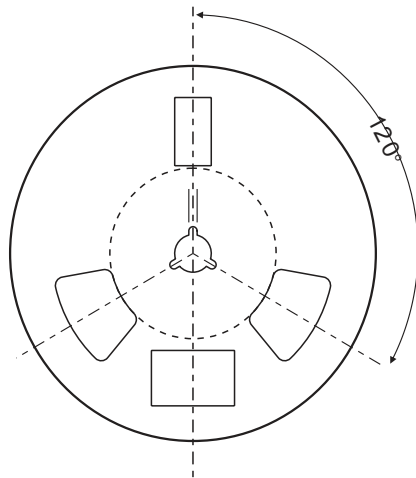
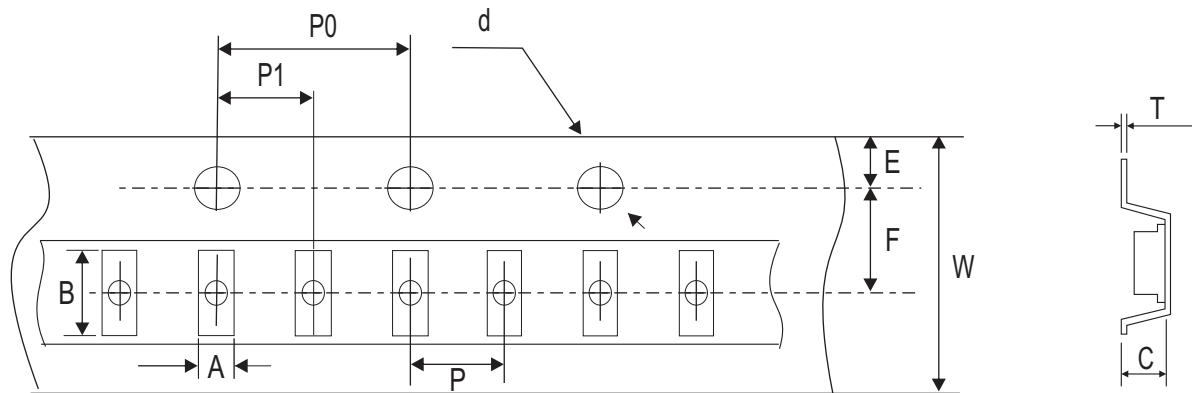

Fig.2 - Power Derating Curve



Reel Taping Specification



0402 (SOD-923F)	SYMBOL	A	B	C	d	D	D ₁	D ₂
	(mm)	0.70 ± 0.05	1.12 ± 0.05	0.48 ± 0.05	1.50 + 0.10 - 0	178.00 Max.	50.00 Min.	13.00 ± 0.50
	(inch)	0.028 ± 0.002	0.044 ± 0.002	0.019 ± 0.002	0.059 + 0.004 - 0	7.008 Max.	1.969 Min	0.512 ± 0.020

0402 (SOD-923F)	SYMBOL	E	F	P	P ₀	P ₁	T	W	W
	(mm)	1.75 ± 0.10	3.50 ± 0.05	2.00 ± 0.05	4.00 ± 0.10	2.00 ± 0.05	0.229 ± 0.02	8.30 Max.	10.90 Max.
	(inch)	0.069 ± 0.004	0.138 ± 0.002	0.079 ± 0.002	0.157 ± 0.004	0.079 ± 0.002	0.009 + 0.001	0.327 Max.	0.429 Max.

Marking Code

Part Number	Marking Code
CPDQ3V3-HF	B



B: Product marking code

⌘: Month Code

Month Code:

Month	Odd Year (per A. D.)	Even Year (per A. D.)
Jan	1	E
Feb	2	F
Wer	3	H
Apr	4	J
May	5	K
Jun	6	L
Jul	7	N
Aug	8	P
Sep	9	U
Oct	T	X
Nov	V	Y
Dec	C	Z

For example as follows:

- Product marking code: B
- Manufacture date_ Year: 2012 (Even year) / Month: Apr
 Month code: J (Month code rotated 90° and two dots below the month code.)

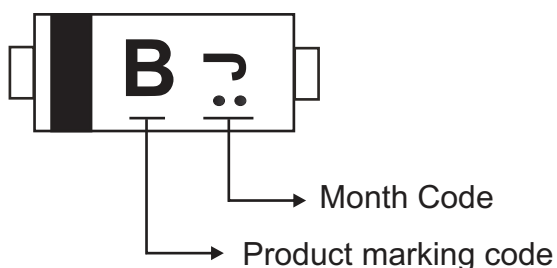

Suggested PAD Layout

SIZE	0402/SOD-923F	
	(mm)	(inch)
A	0.90	0.035
B	0.30	0.012
C	0.40	0.016
D	1.20	0.047
E	0.60	0.024

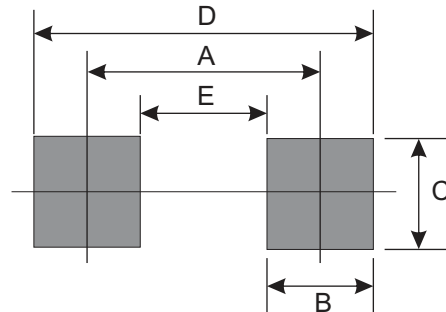

Standard Packaging

Case Type	Qty Per Reel	Reel Size
	(Pcs)	(inch)
0402/SOD-923	8,000	7