

83880 with cable output Metal roller plunger Part number 83881101

- IP 66/67
- Metal case
- cUL approval

Part numbers

Type	Characteristics	Type of output
83881101 Metal roller plunger	Standard	Cable length 1 m

Specifications

Conformity to standards	IEC / EN 60947.5.1 Dimensional conformity : NFC 63145 Low voltage directive : 73/23/EEC and 93/68/EEC Electric shock protection : NFC 20030 or IEC 60536 class 1, degree of pollution 3
Protection against electric shocks	
Degree of protection IEC 60529	
Degree of protection according to NEMA 250	Type 1, 3, 4, 6, 13

Electrical characteristics

Connection	
Operating temperature (°C)	-25 → +70 °C
Assigned impulse voltage (Uimp) - V	2500
Assigned insulation voltage Ui (V)	500
Thermal current I (A)	10
Low-load switching - Minimum voltage (V)	10
Low-load switching - Minimum current (mA)	100
Assigned working characteristics (EN 60 947.5.1, UL 508)	A300 = AC15 250 V 6 A Q150 = DC13 24 V 8 A
Use category according to IEC 947.5.1	AC15=250 V/6 A DC13=24 V/8 A
Use category according to UL 508	A300 - Q150
Electrical protection	Integral earth wire Short-circuit protection device : IEC/EN 60947.5.1 Fuse 6 AgC
Approvals	UL 508, UL 50

Mechanical characteristics

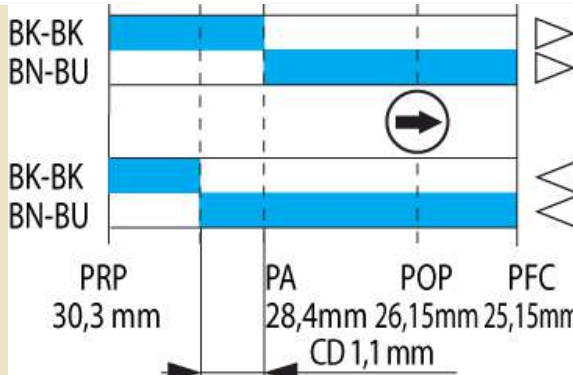
Sequence Snap action	
Minimum operating force (N)	10
Minimum operating force (Nm)	-
Minimum total travel force (N)	30
Minimum total travel force (Nm)	-
Min. positive opening travel (N)	28
Min. positive opening travel (Nm)	-
Mechanical life (millions of operations)	10

Vertical approach speed	1 mm/min → 0,5 m/s
Horizontal approach speed (30° cam)	1 mm/min → 0,3 m/s
Weight (g)	200

Principles

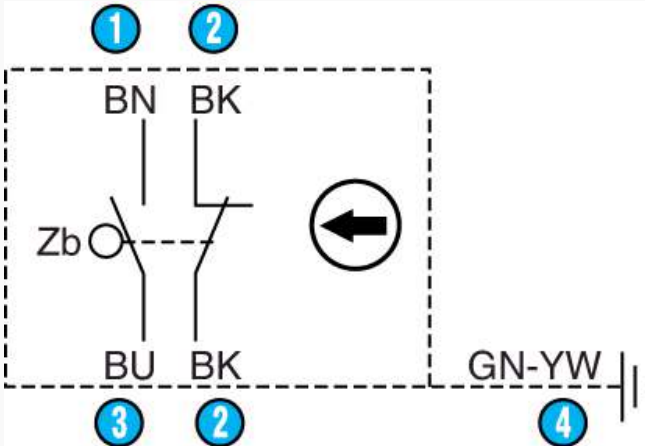

Function

Four-terminal double break two-way contact element (form Zb) with positive opening NC contacts. The 2 moving contacts are electrically isolated from one another.

N°	Legend
1	Brown
2	Black
3	Blue
4	Green-yellow

Dimensions (mm)

Product

83 881 1

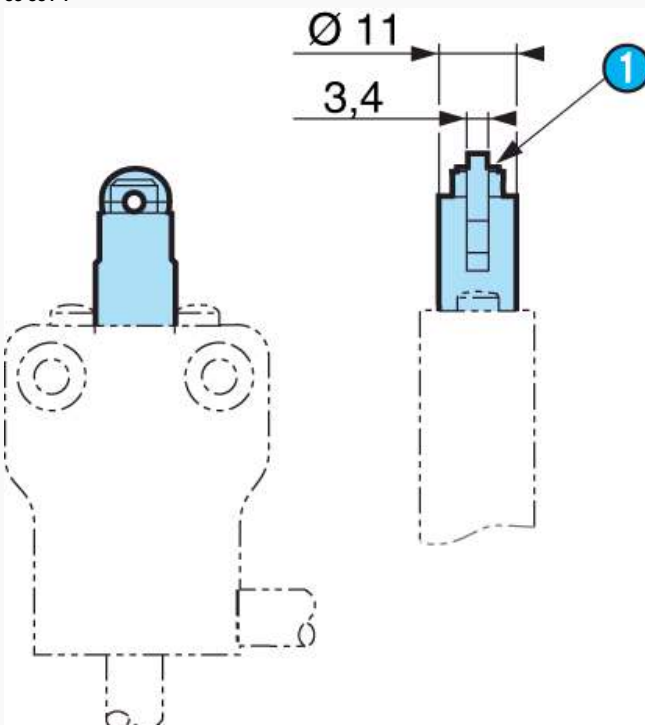

83 881 0

N°	Legend
1	POP marking

Dimensions (mm)

Product

83 885 1

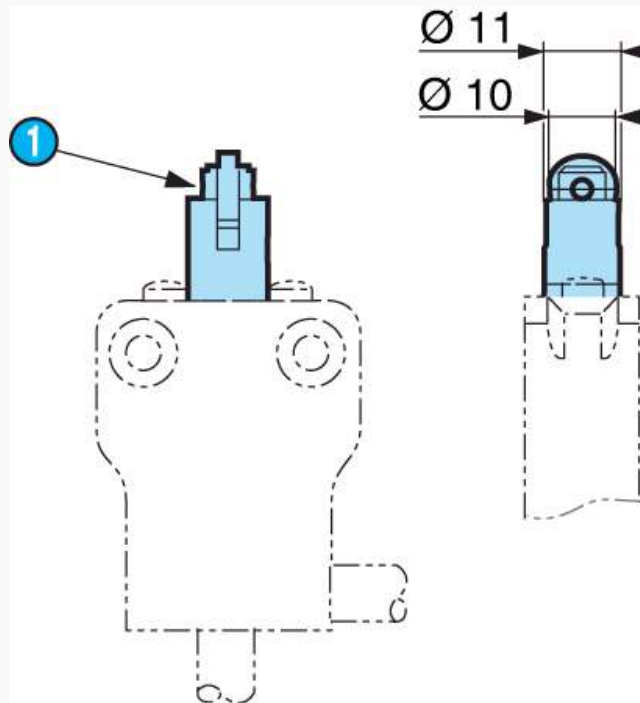

83 885 0

N°	Legend
1	POP marking

Product adaptations



- Contact type
- Rear output
- Protective scraper seal
- Length of cable/connector/stripping
- Connector output
- Low level contact