



TAOGLAS®



Datasheet

Havok

Part No:
PCS.06.M

Description:

Havok - Low Profile 4G Cellular SMD Dielectric Antenna

Features:

4G LTE Antenna

SMD Dielectric Antenna

3G/2G Fallback

698~960MHz/1710~2690MHz High Efficiency Multi-Band SMD antenna

Low profile

Dimensions: 42*10*3mm

RoHS & REACH Compliant

1. Introduction	3
2. Specifications	4
3. Antenna Characteristics	6
4. Radiation Patterns	9
5. Mechanical Drawing	18
6. Antenna Integration Guide	19
7. Packaging	27
<hr/>	
Changelog	29

Taoglas makes no warranties based on the accuracy or completeness of the contents of this document and reserves the right to make changes to specifications and product descriptions at any time without notice. Taoglas reserves all rights to this document and the information contained herein. Reproduction, use or disclosure to third parties without express permission is strictly prohibited.



1. Introduction



The Havok PCS.06.M is a low profile 4G Cellular SMD Dielectric embedded antenna designed for direct SMD mount on a device PCB. It provides high efficiency in a very small factor 42*10*3mm. If tuning is required it can be tuned for the device environment, while there is no need for new tooling.

Its rectangular shape and very small size make it very easy to integrate – packaged in tape and reel, it can be mounted via pick and place to reflow solder directly on the edge of the PCB board. This antenna is recommended to be used with longer ground-plane lengths of 120mm or more to attain its highest rated efficiency, note the return loss and efficiency graphs in this datasheet.

The PCS.06.M is a mirrored version of the standard PCS.06.A and it has been designed to operate in parallel with the PCS.06.A in a MIMO system.

Typical Applications Include:

- Handheld Devices
- Remote Monitoring
- MIMO Cellular Devices

The antenna is suitable for lower cost cellular applications, especially for telematics and automotive sector. Contact your regional Taoglas customer support team for quick and professional support from our senior engineering team on integration and matching of the antenna to your device.

2. Specifications

Electrical							
Band	Frequency (MHz)	Efficiency (%)	Average Gain (dB)	Peak Gain (dBi)	Impedance	Polarization	Max. input power
5G NR/4G Band 5,8,12,13,14,17,18,20,26,27,28, 29	698~960	50	-3.1	0.5	50Ω	Linear	5W
5G NR/4G Band 21,32,74,75,76	1427~1518	34	-4.8	1.0			
4G/3G Band 1,2,3,4,9,23,25,35,39,66	1710~2200	61	-2.1	3.4			
Wi-Fi 2400	2400~2500	44	-3.5	2.6			
4G/3G Band 7,38,41	2490~2690	49	-3.0	2.9			
Mechanical							
Antenna Dimensions	42mm x 10mm x 3mm						
Material	FR4						
Weight	2.5g						
Soldering Type	SMD through Reflow						
Environmental							
Temperature Range	-40°C to 85°C						

* All measurements were done on 120*45mm EVB board with 100mm length ground plane.

5G/4G Bands			
Band Number	5G NR / FR1 / LTE / LTE-Advanced / WCDMA / HSPA / HSPA+ / TD-SCDMA		
	Uplink	Downlink	Covered
1	UL: 1920 to 1980	DL: 2110 to 2170	✓
2	UL: 1850 to 1910	DL: 1930 to 1990	✓
3	UL: 1710 to 1785	DL: 1805 to 1880	✓
4	UL: 1710 to 1755	DL: 2110 to 2155	✓
5	UL: 824 to 849	DL: 869 to 894	✓
7	UL: 2500 to 2570	DL: 2620 to 2690	✓
8	UL: 880 to 915	DL: 925 to 960	✓
9	UL: 1749.9 to 1784.9	DL: 1844.9 to 1879.9	✓
11	UL: 1427.9 to 1447.9	DL: 1475.9 to 1495.9	✓
12	UL: 699 to 716	DL: 729 to 746	✓
13	UL: 777 to 787	DL: 746 to 756	✓
14	UL: 788 to 798	DL: 758 to 768	✓
17	UL: 704 to 716	DL: 734 to 746	✓
18	UL: 815 to 830	DL: 860 to 875	✓
19	UL: 830 to 845	DL: 875 to 890	✓
20	UL: 832 to 862	DL: 791 to 821	✓
21	UL: 1447.9 to 1462.9	DL: 1495.9 to 1510.9	✗
22	UL: 3410 to 3490	DL: 3510 to 3590	✗
23	UL: 2000 to 2020	DL: 2180 to 2200	✓
24	UL: 1625.5 to 1660.5	DL: 1525 to 1559	✗
25	UL: 1850 to 1915	DL: 1930 to 1995	✓
26	UL: 814 to 849	DL: 859 to 894	✓
27	UL: 807 to 824	DL: 852 to 869	✓
28	UL: 703 to 748	DL: 758 to 803	✓
29	UL: -	DL: 717 to 728	✓
30	UL: 2305 to 2315	DL: 2350 to 2360	✓
31	UL: 452.5 to 457.5	DL: 462.5 to 467.5	✗
32	UL: -	DL: 1452 - 1496	✗
35		1850 to 1910	✓
38		2570 to 2620	✓
39		1880 to 1920	✓
40		2300 to 2400	✓
41		2496 to 2690	✓
42		3400 to 3600	✗
43		3600 to 3800	✗
48		3550 to 3700	✗
66	UL: 1710-1780	DL: 2110-2200	✓
71		617 to 698	✗
74/75/76		1427 to 1518	✗
78		3300 to 3800	✗
79		4400 to 5000	✗
126		410 to 430	✗

3. Antenna Characteristics

3.1 Return Loss

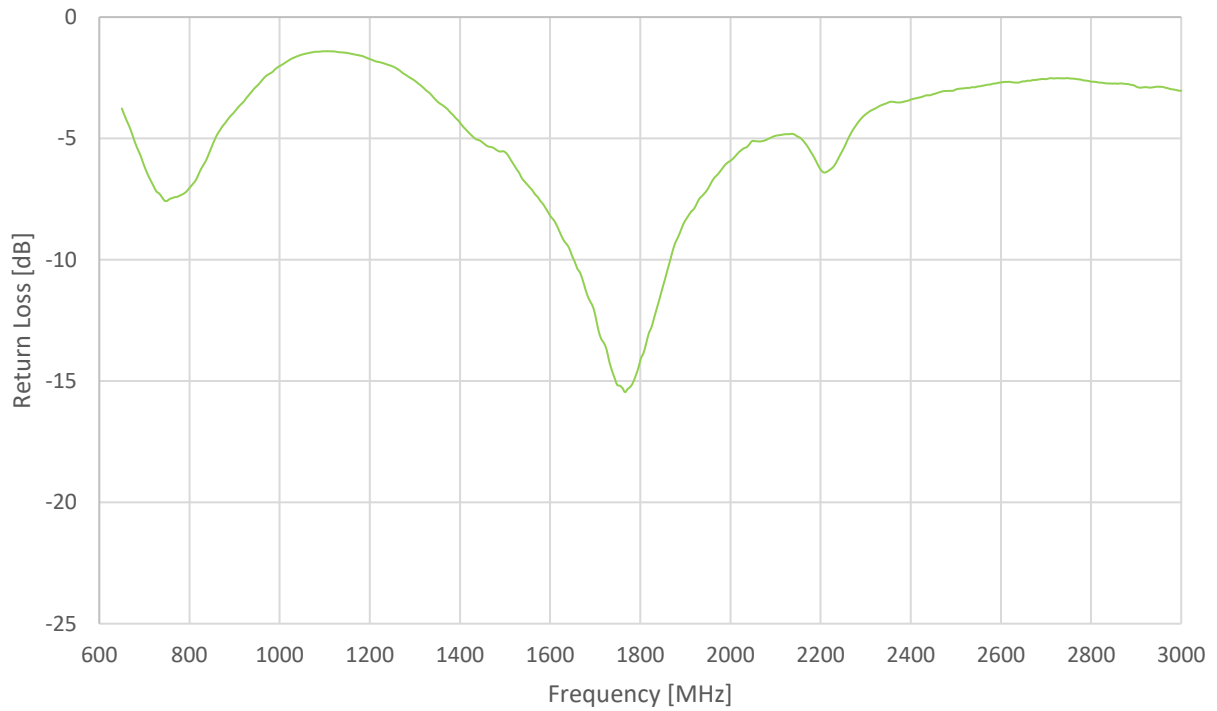

3.2 VSWR

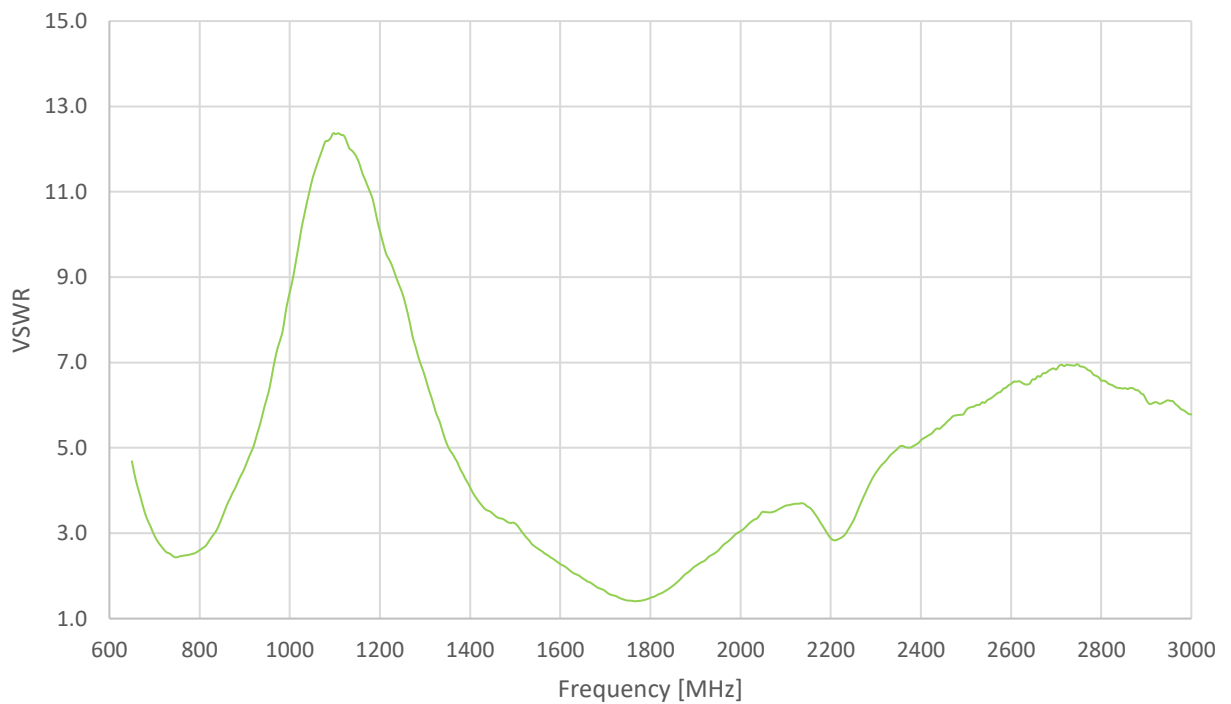

3.3 Efficiency

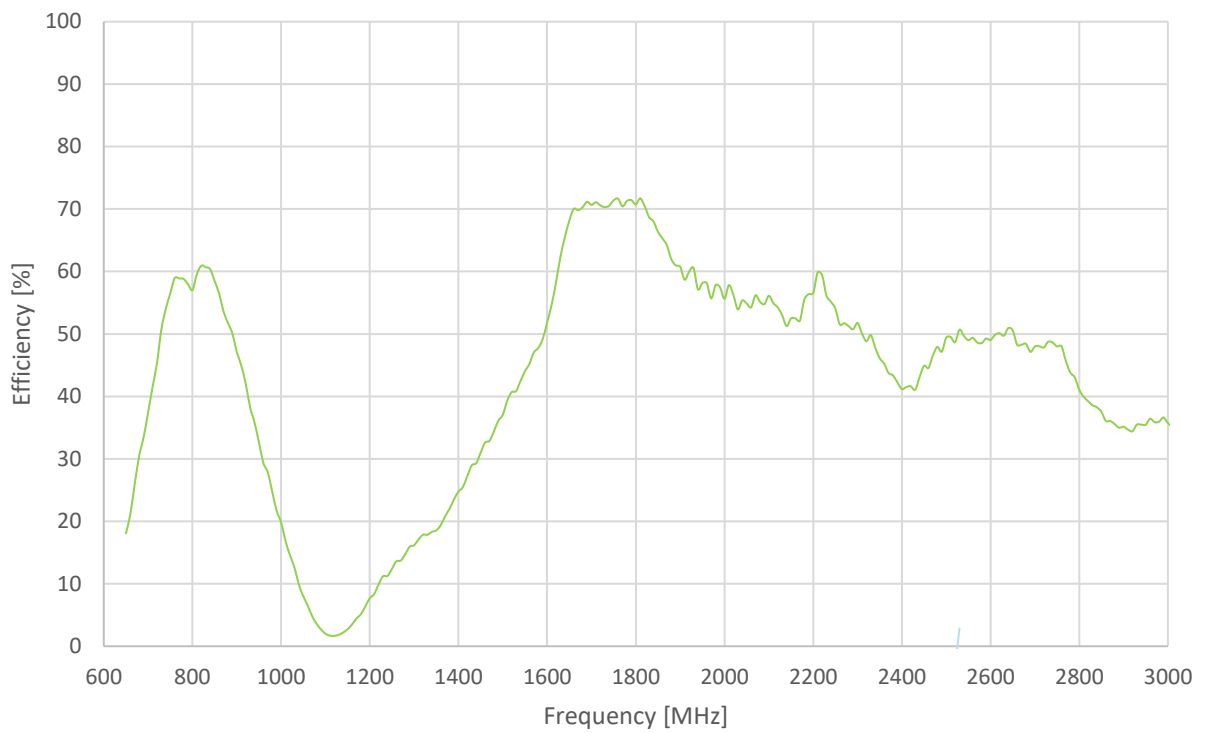

3.4 Peak Gain

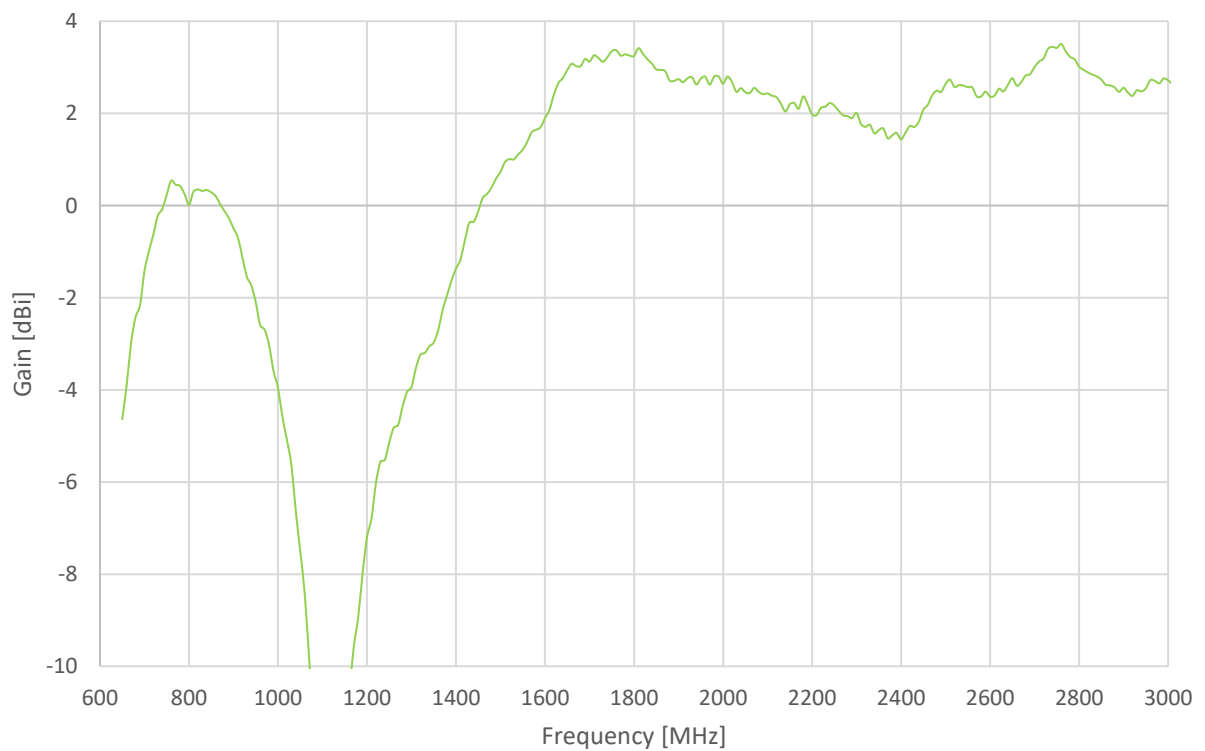

3.5 Average Gain

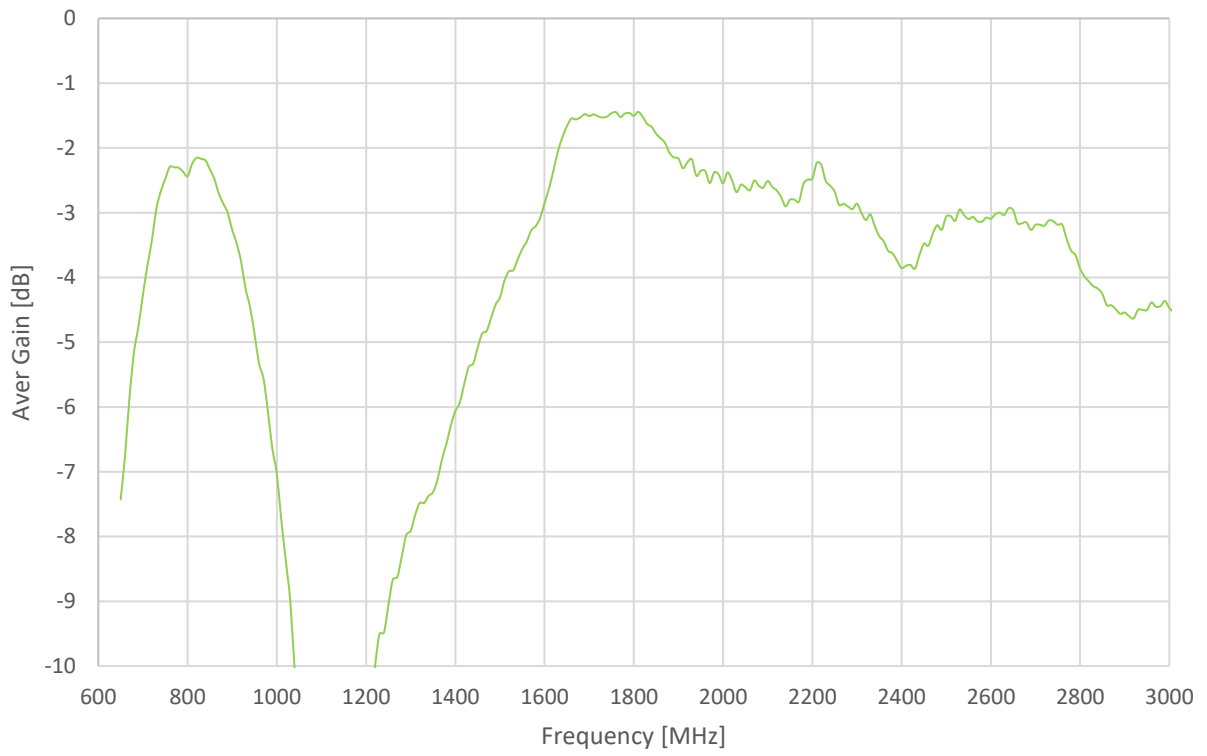

4. Radiation Patterns

4.1 Test Setup

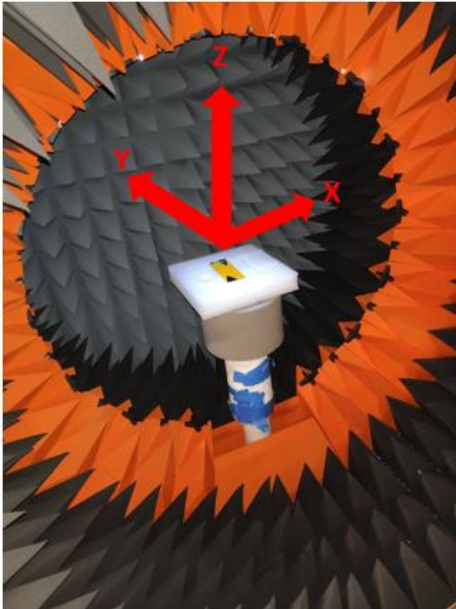

Chamber Setup

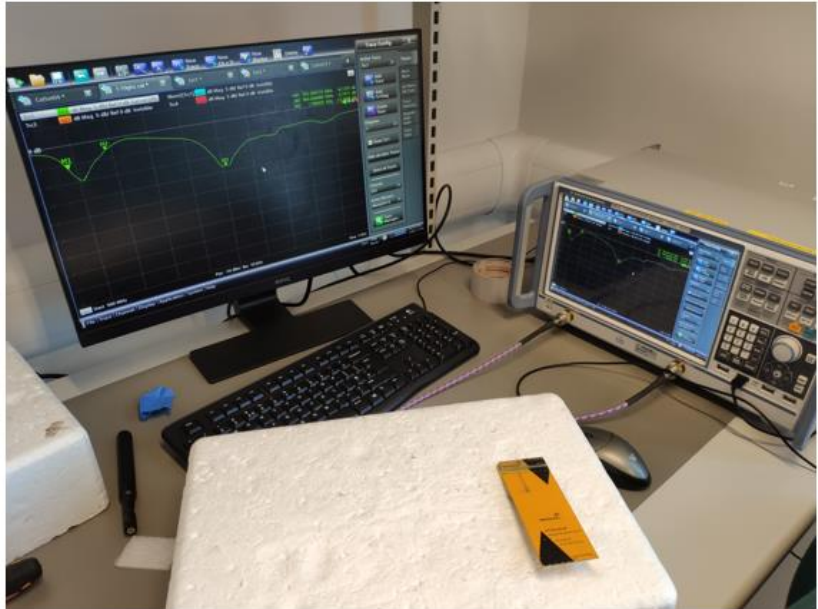

VNA Setup

4.2 700MHz 3D & 2D Radiation Patterns

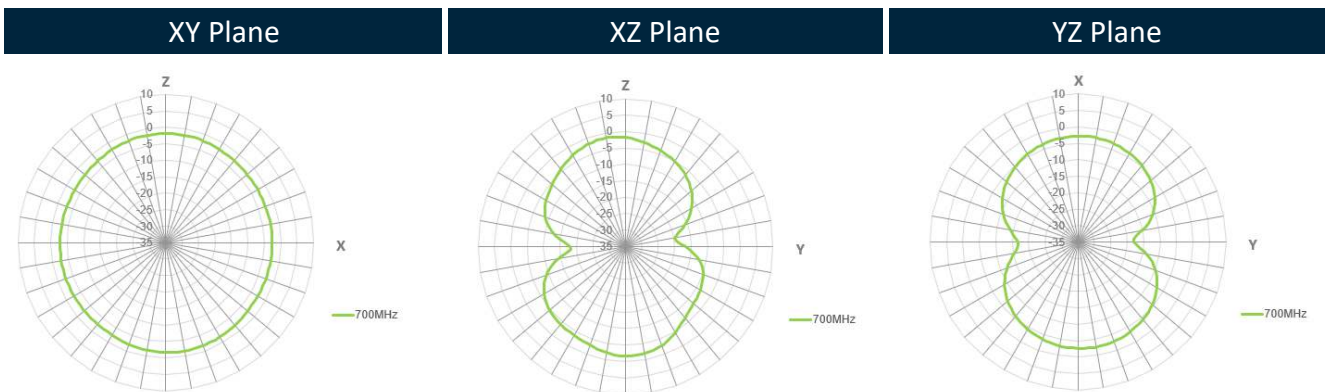
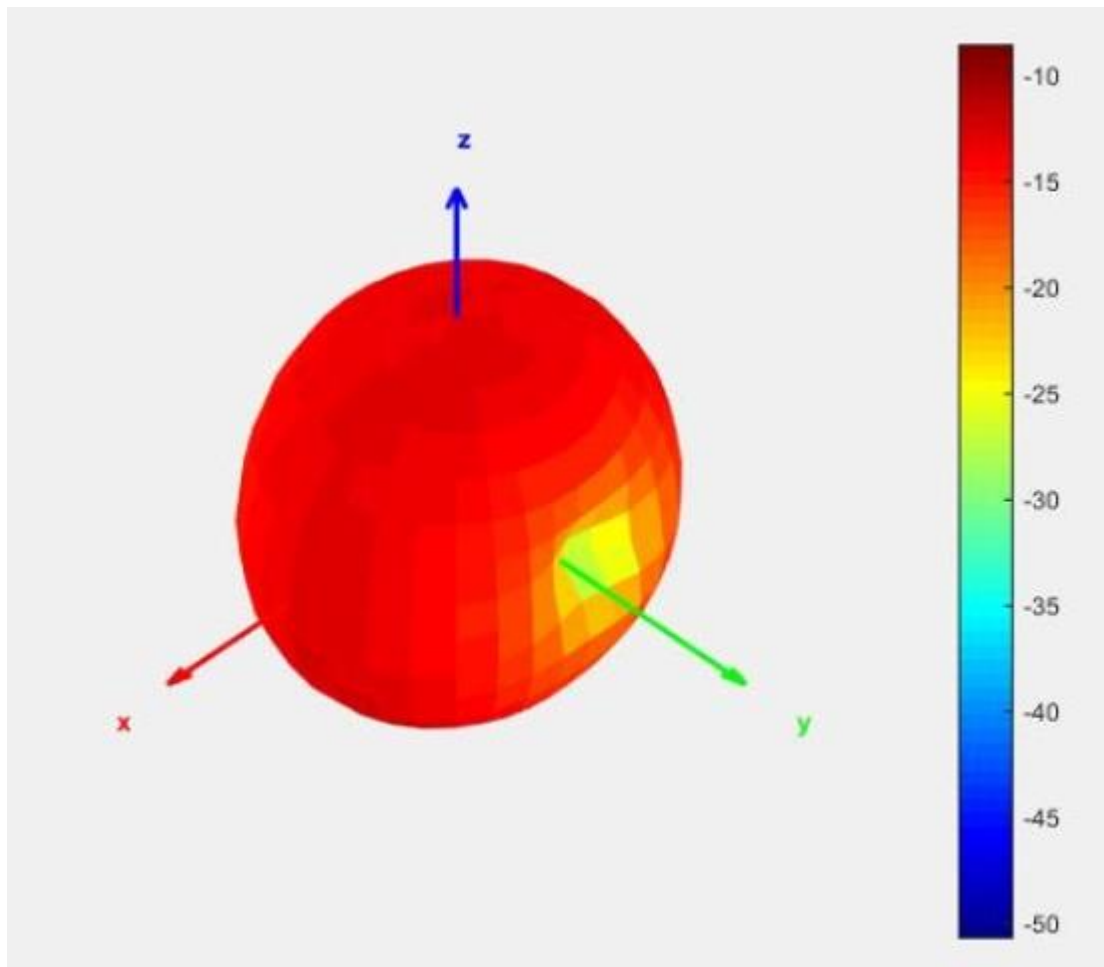

880MHz

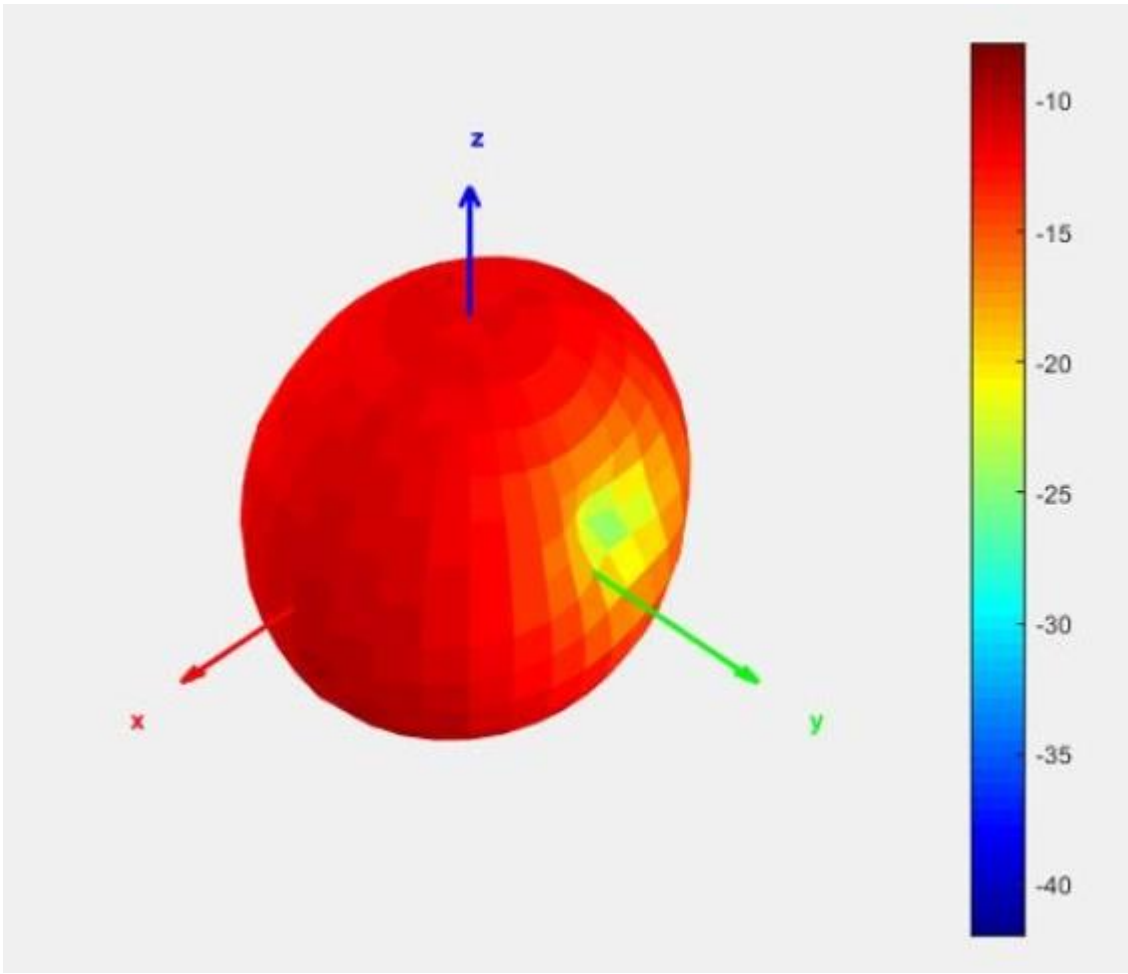

XY Plane

XZ Plane

YZ Plane

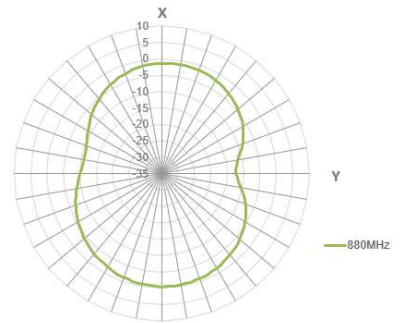
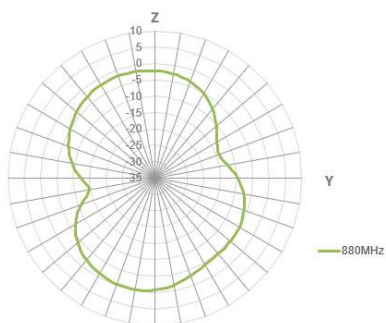
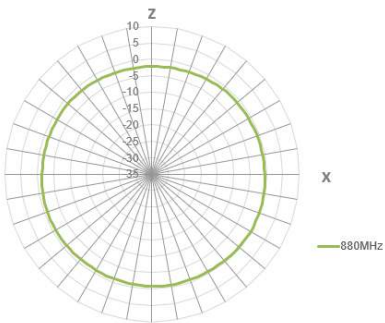

960MHz

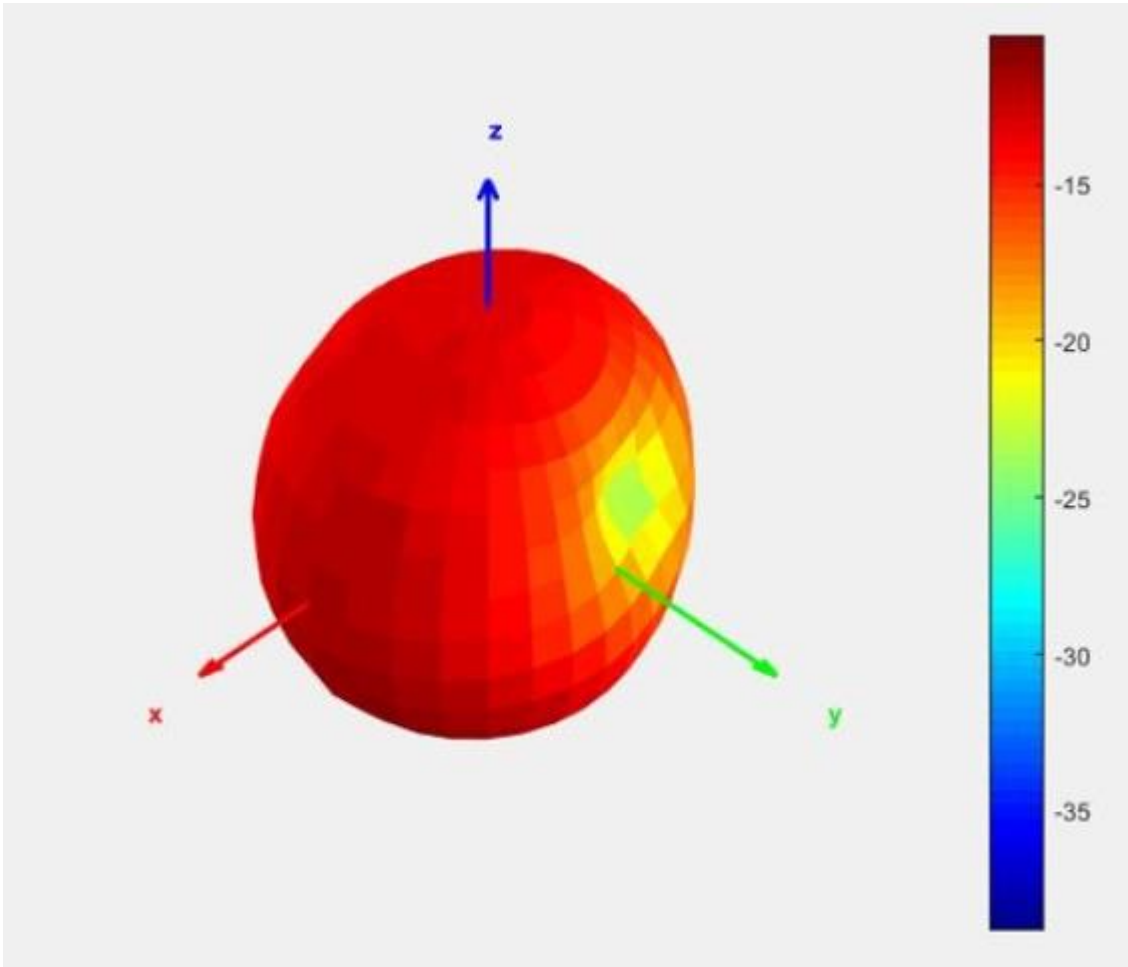

XY Plane

XZ Plane

YZ Plane

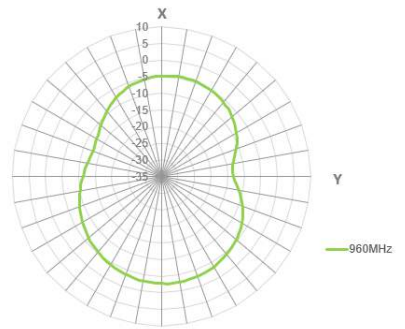
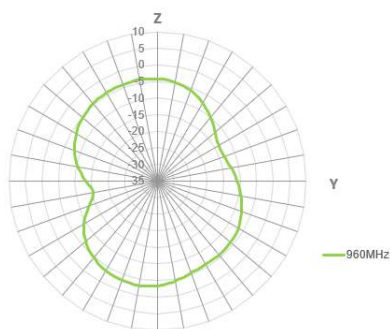
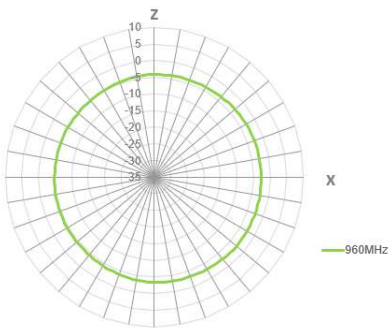

1700MHz

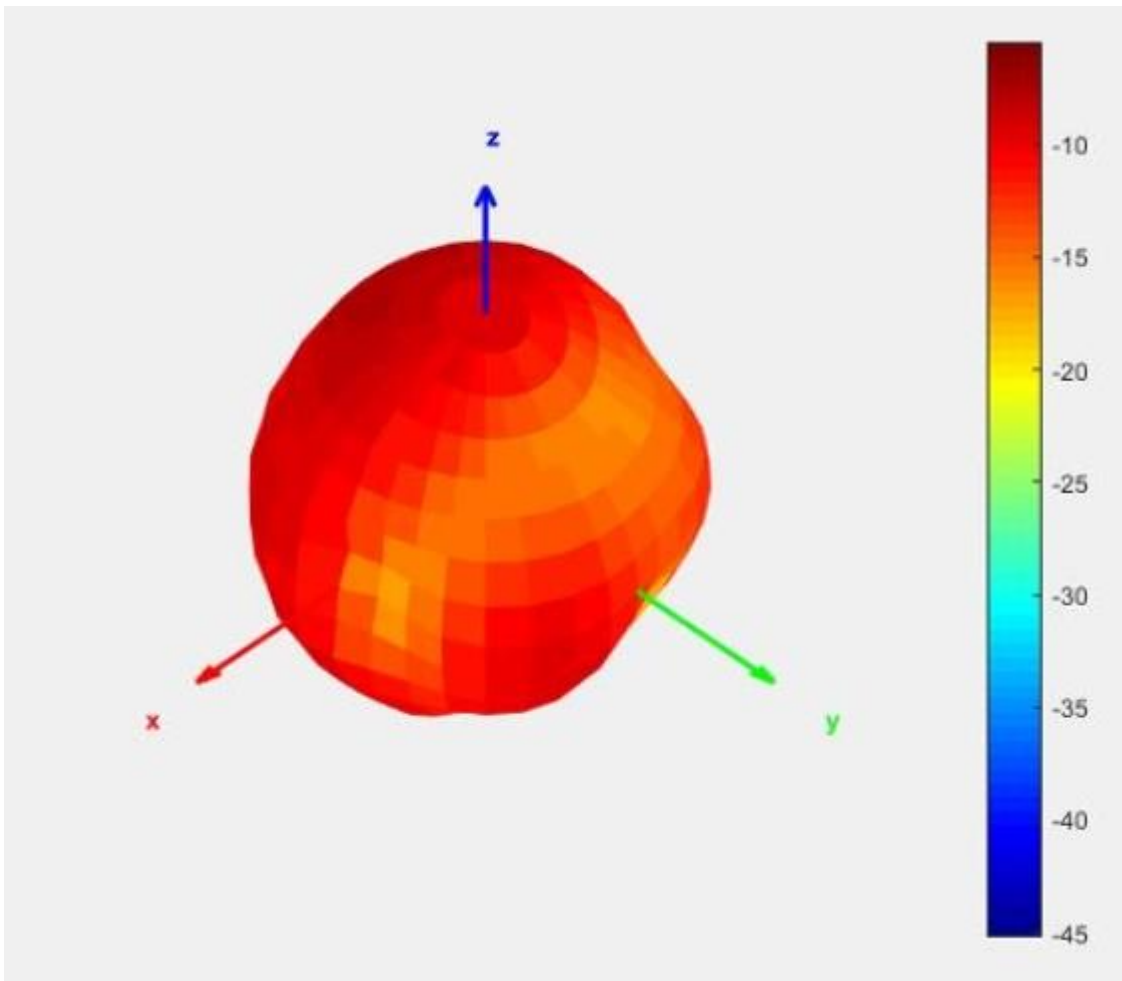

XY Plane

XZ Plane

YZ Plane

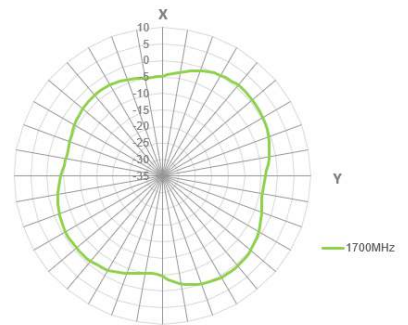
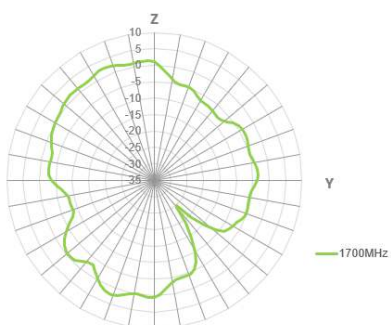
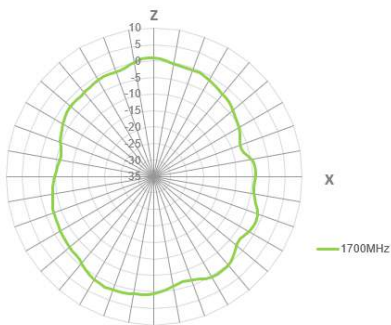

1800MHz

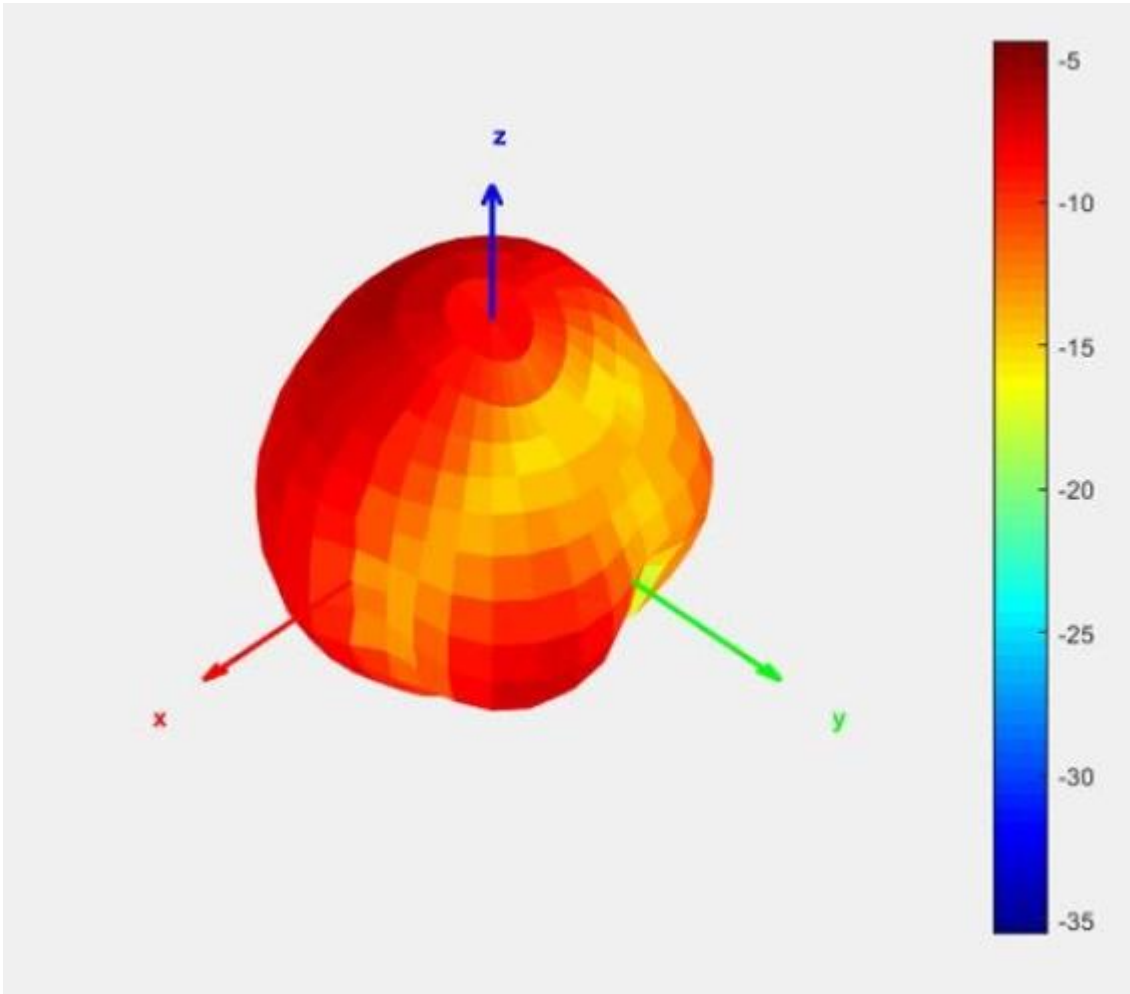

XY Plane

XZ Plane

YZ Plane

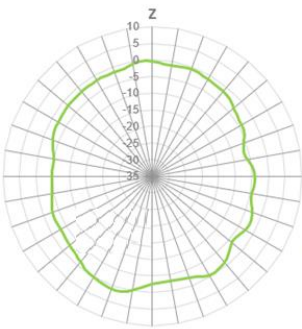

1800 MHz

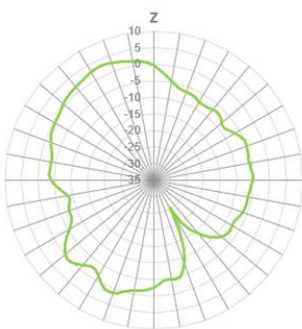

1800 MHz

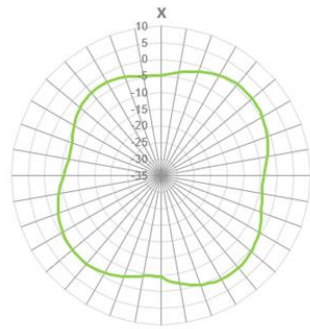

1800 MHz

1900MHz

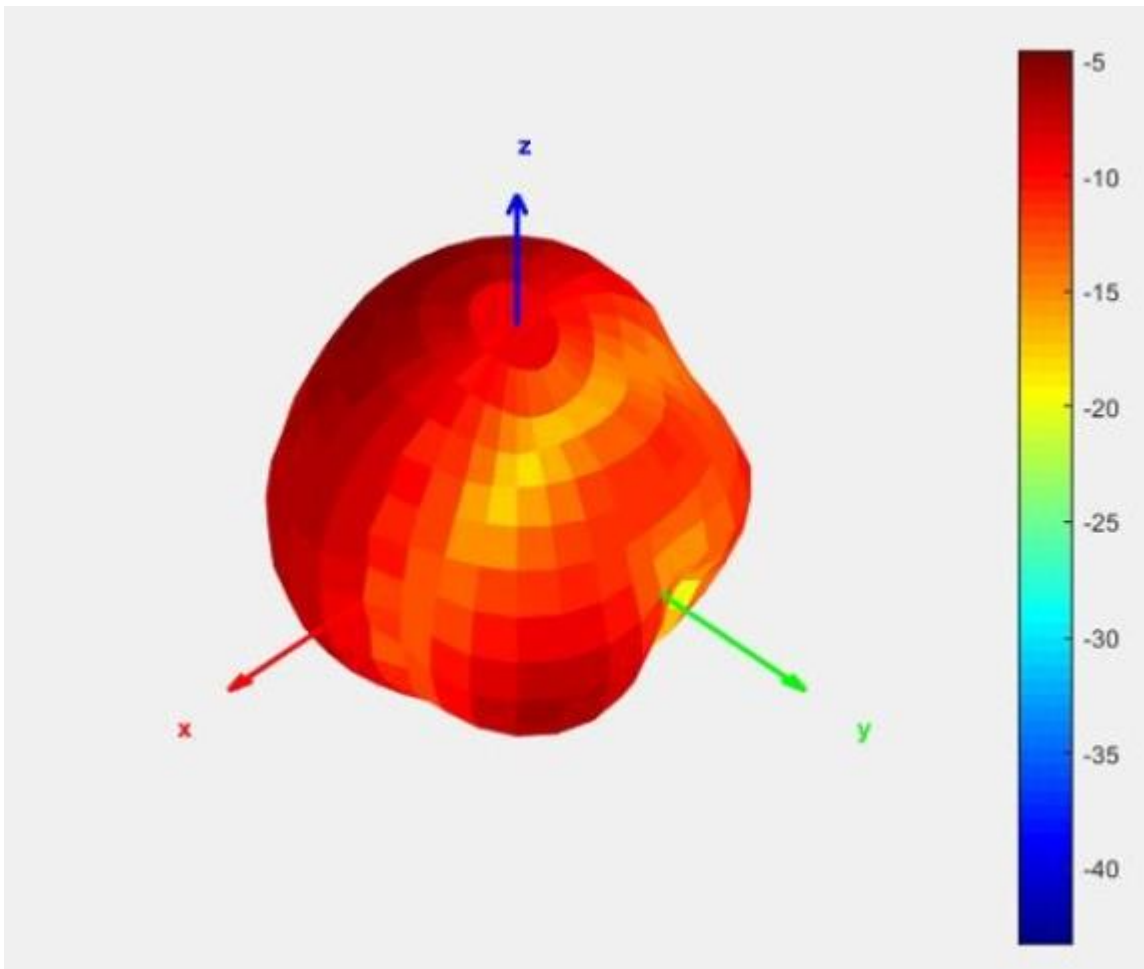

XY Plane

XZ Plane

YZ Plane

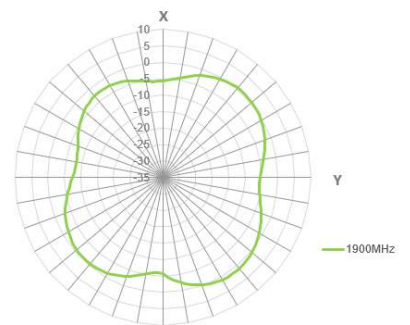
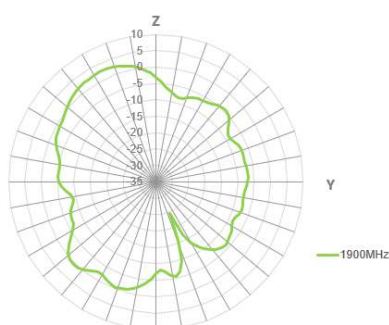
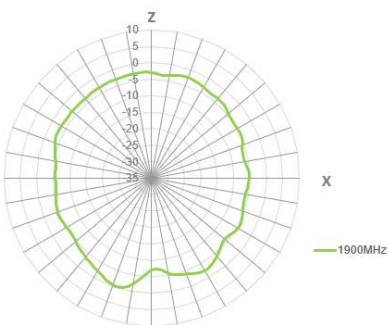

2100MHz

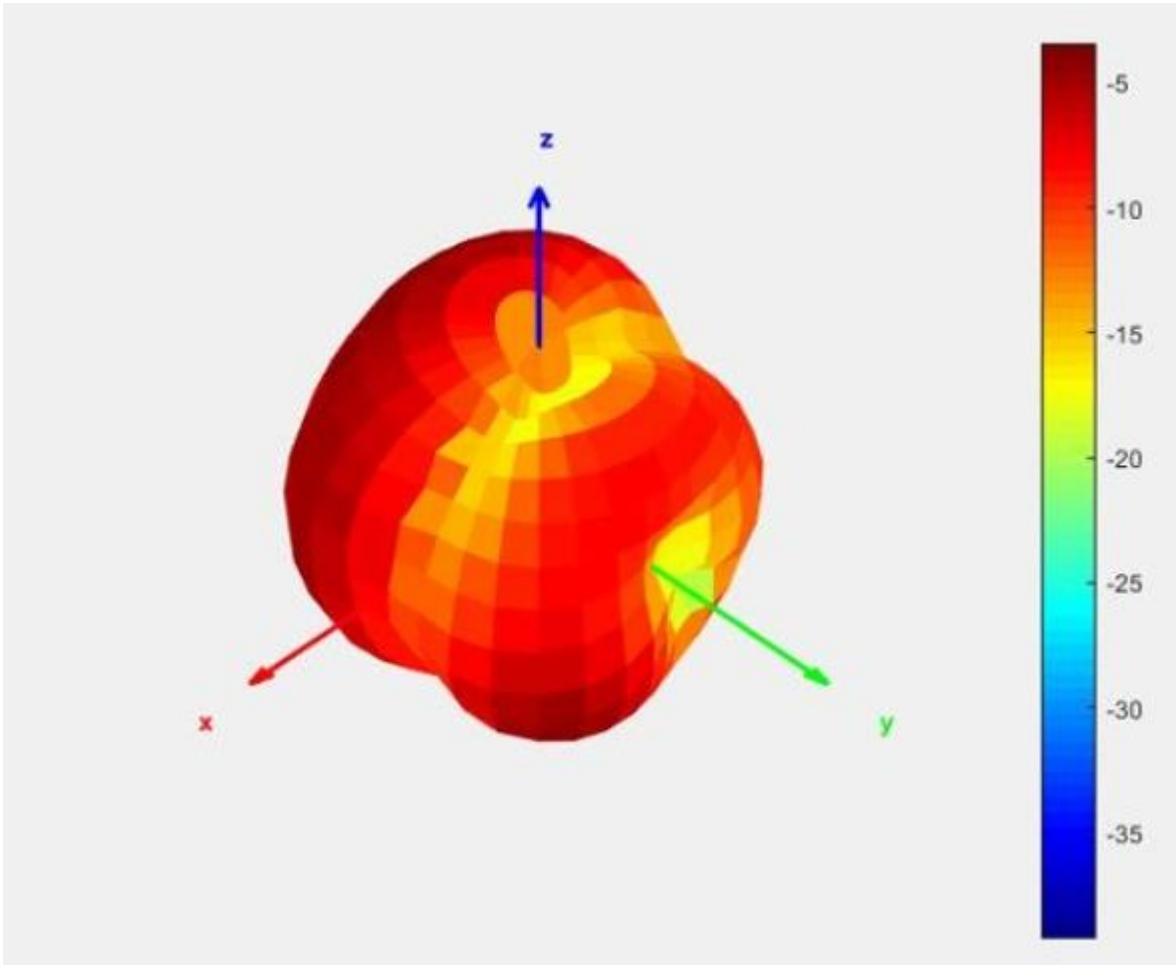

XY Plane

XZ Plane

YZ Plane

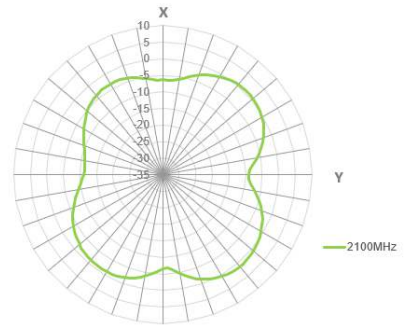
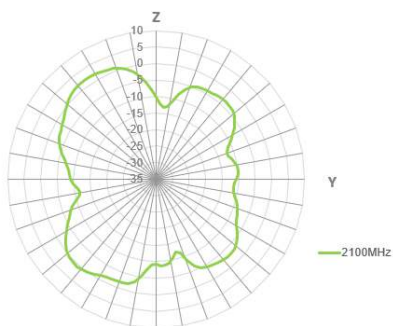
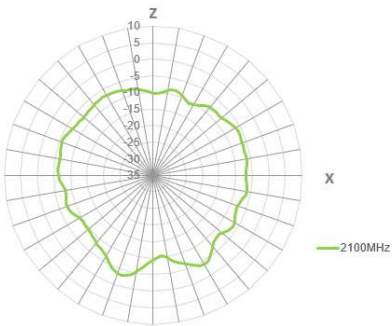

2700MHz

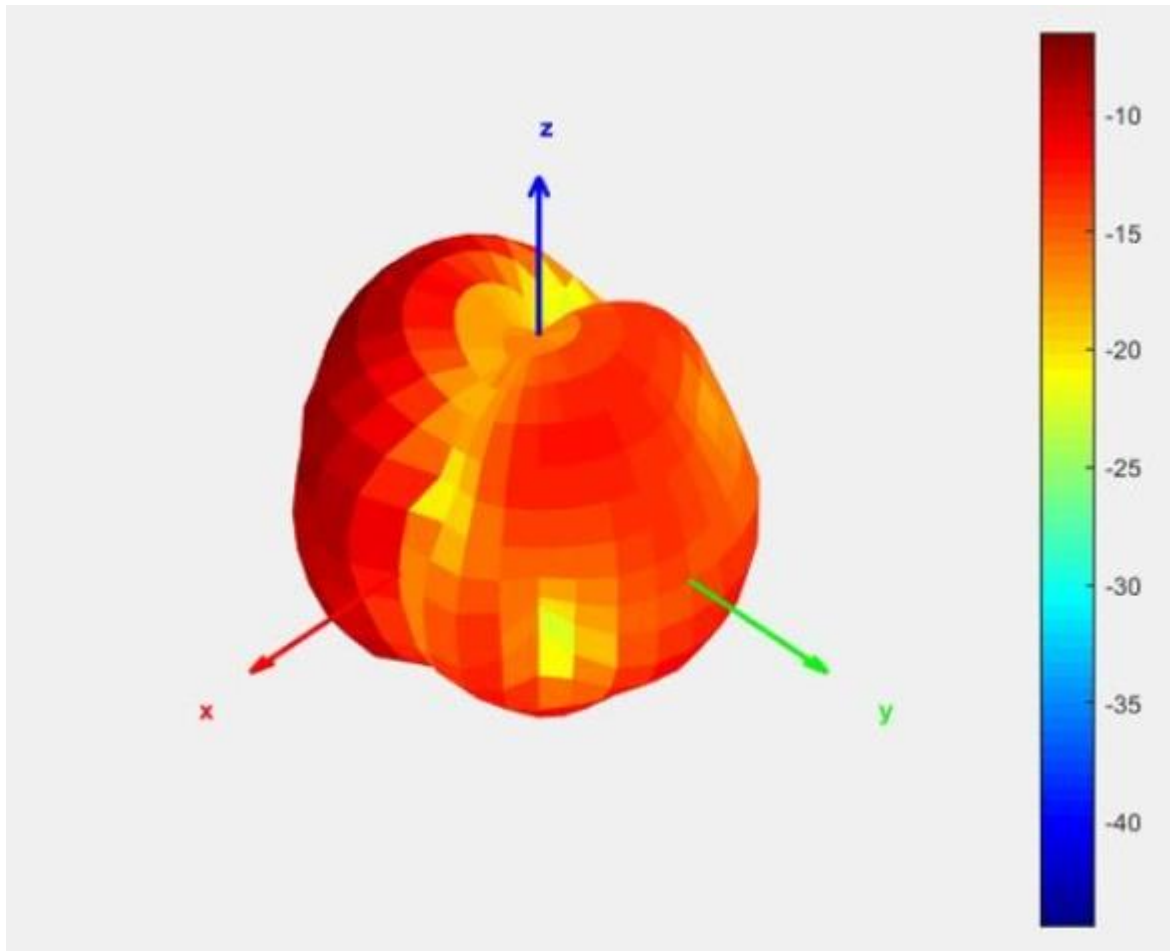

XY Plane

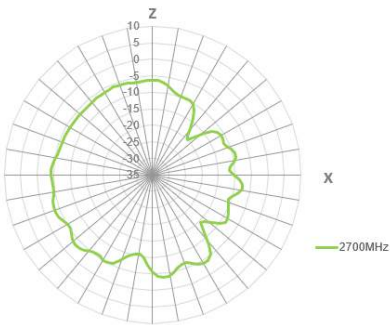

XZ Plane

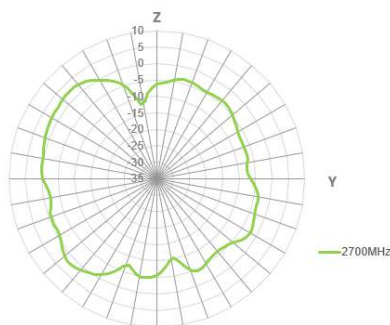

YZ Plane

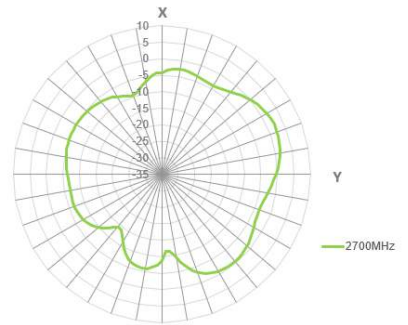

5. Mechanical Drawing (Units: mm)

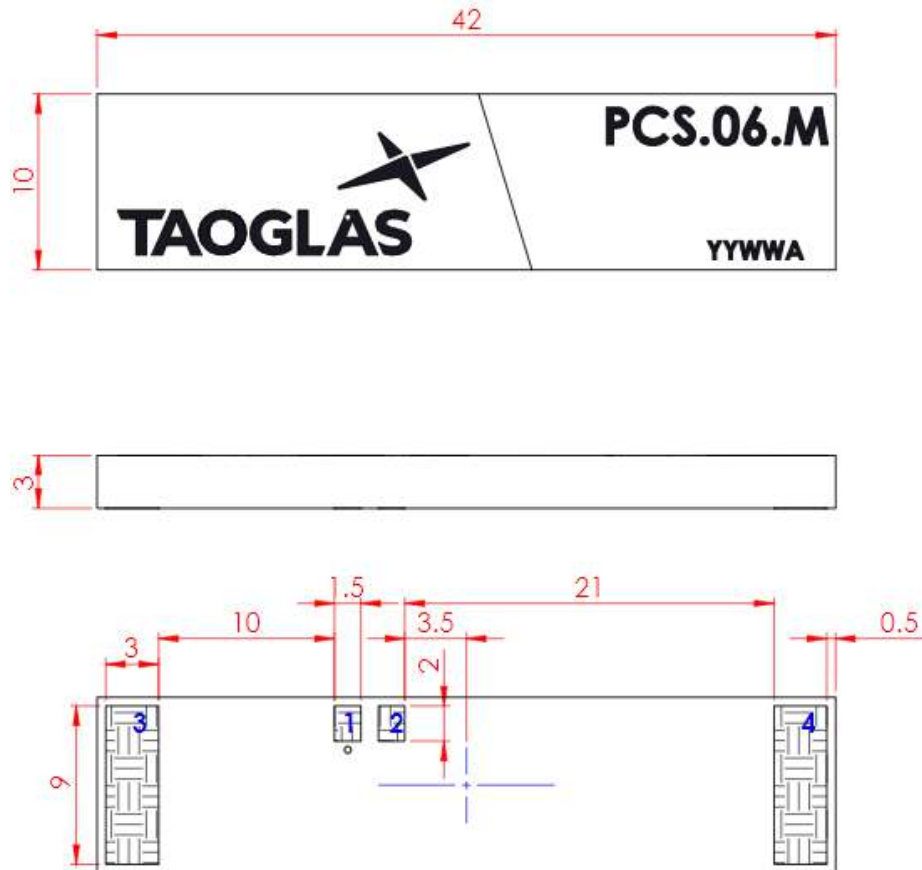

PIN	DESCRIPTION:
1	RF FEED (50 Ohm)
2	GROUND
3	MECHANICAL/NOT CONNECTED
4	MECHANICAL/NOT CONNECTED

6. Antenna Integration Guide



6.1 Schematic Symbol and Pin Definition

The circuit symbol for the antenna is shown below. The antenna has 4 pins with only two pins (Pin 1 and Pin 2) as functional. Pins 3 and 4 are for mechanical strength.

Pin	Description
1	RF Feed
2	Ground
3, 4	Mechanical, Not Connected

ANT1 PCS.06.M

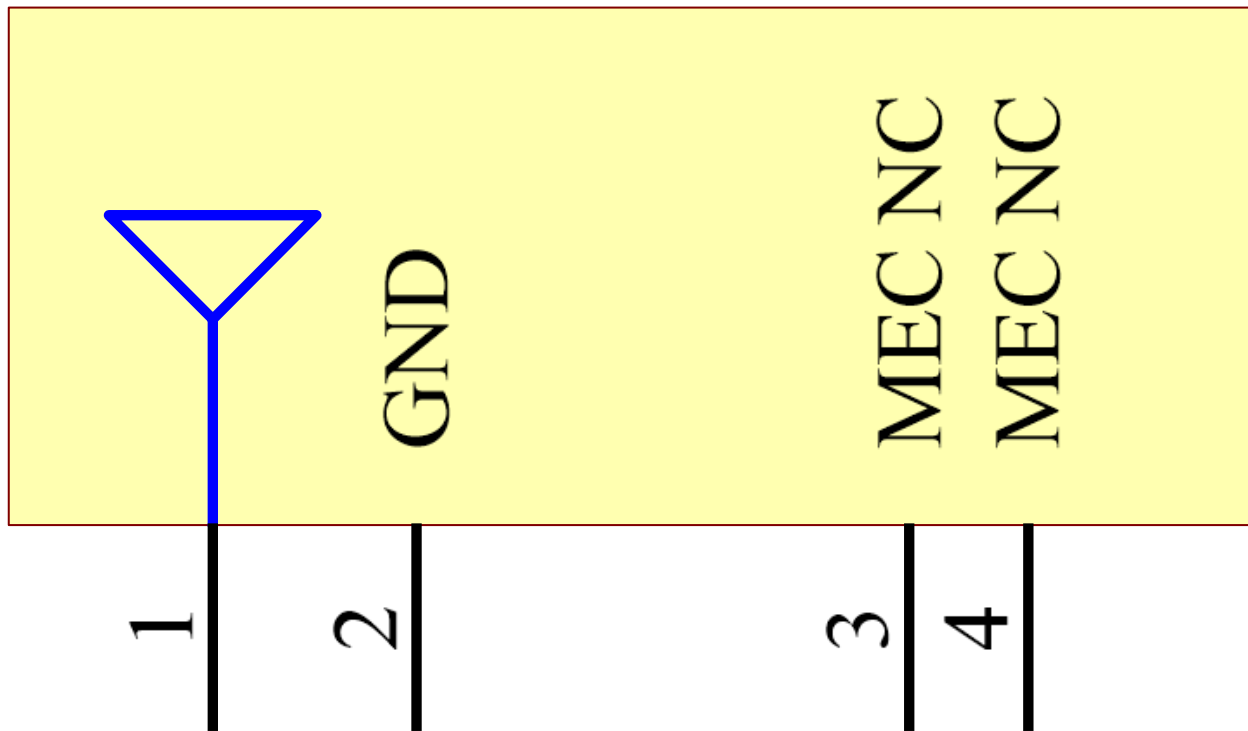

6.2 Antenna Integration

Whatever the size of the PCB, the antenna should ideally be placed on the PCB's shortest side, to take advantage of the ground plane. Optimized matching components can be placed as shown.



6.3 PCB Layout

The footprint and clearance on the PCB must meet the antenna specification. An example of the PCB layout shows the antenna footprint with clearance. Note the placement of the optimized components. L1 is positioned outside the ground plane and C1 is sitting across the ground plane and the copper clearance area. C2 is optional as a component but it is recommended to include these pads in case they are needed.

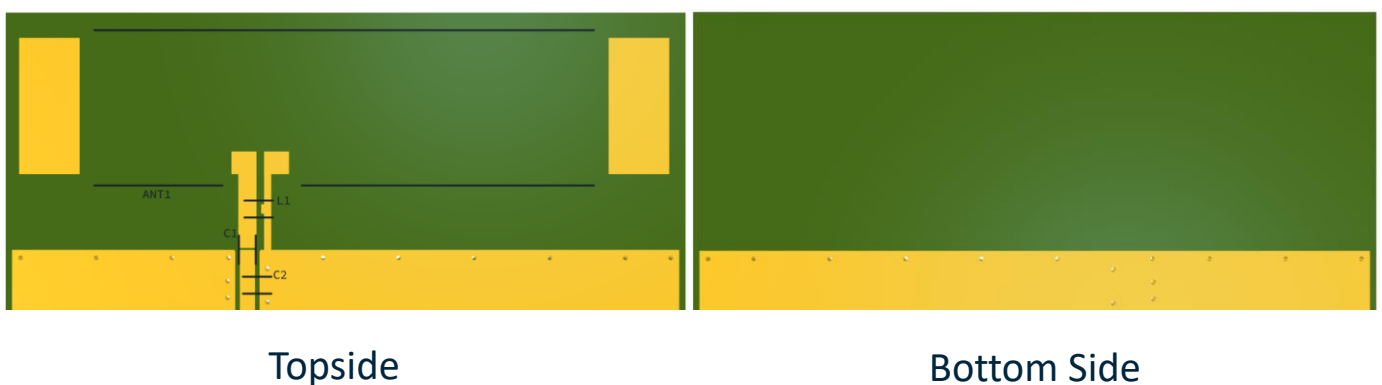

Topside

Bottom Side

6.4 PCB Clearance

Below shows the antenna footprint and clearance through ALL layers on the PCB. Only the antenna pads and connections to feed and GND are present within this clearance area (marked RED). The clearance area extends to 5mm from the antenna mechanical pads to the ground area. This clearance area includes the bottom side and ALL internal layers on the PCB.

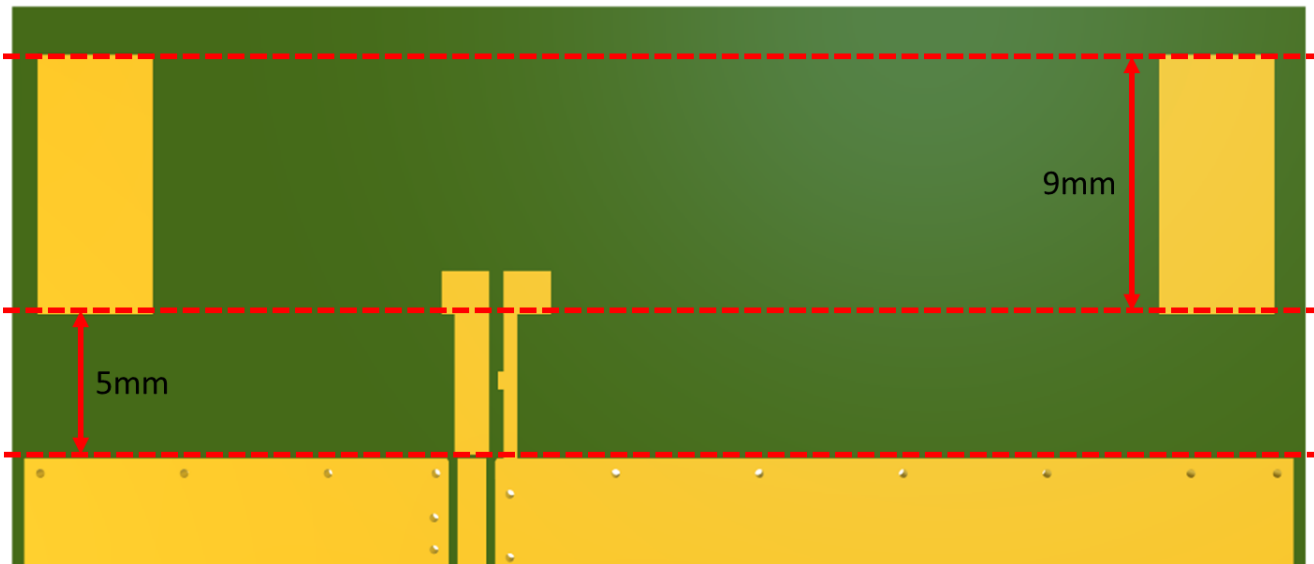

Topside

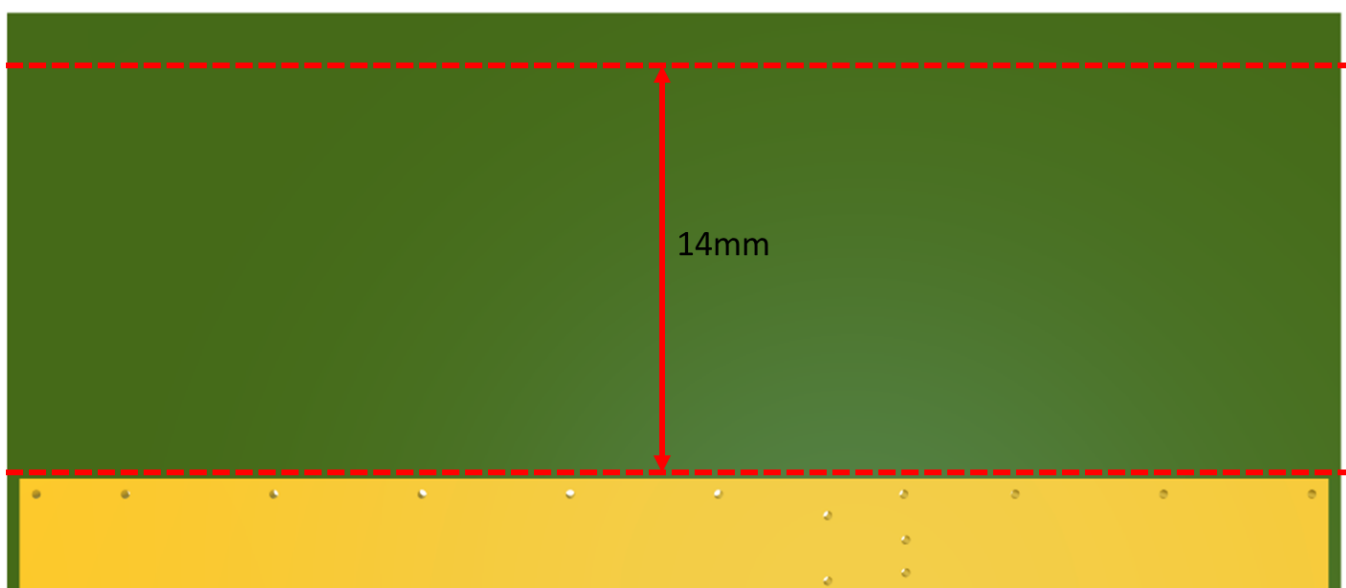

Bottom Side

6.5 Evaluation Board

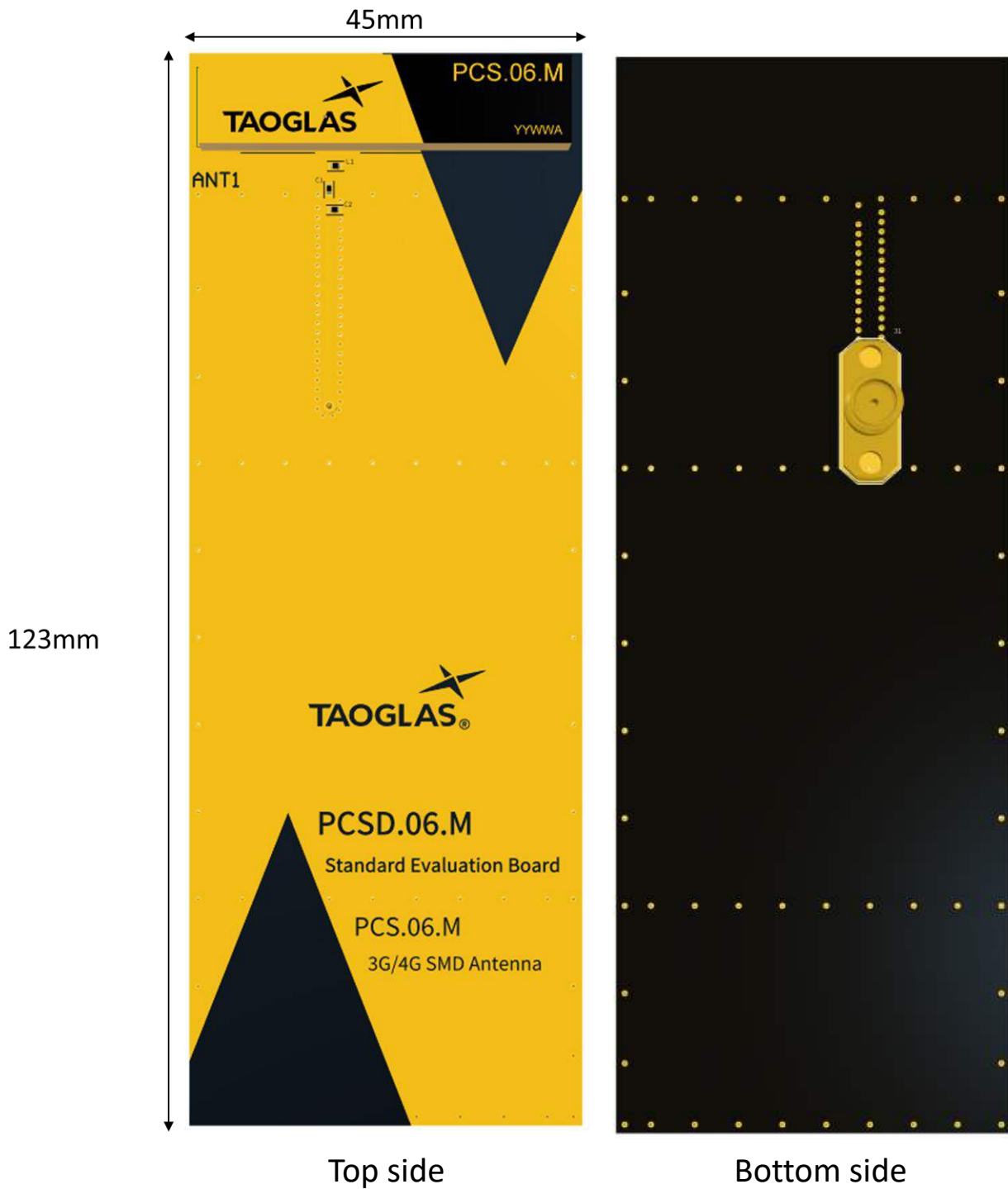

Top side

Bottom side

6.6 Evaluation Board Ground Plane Length

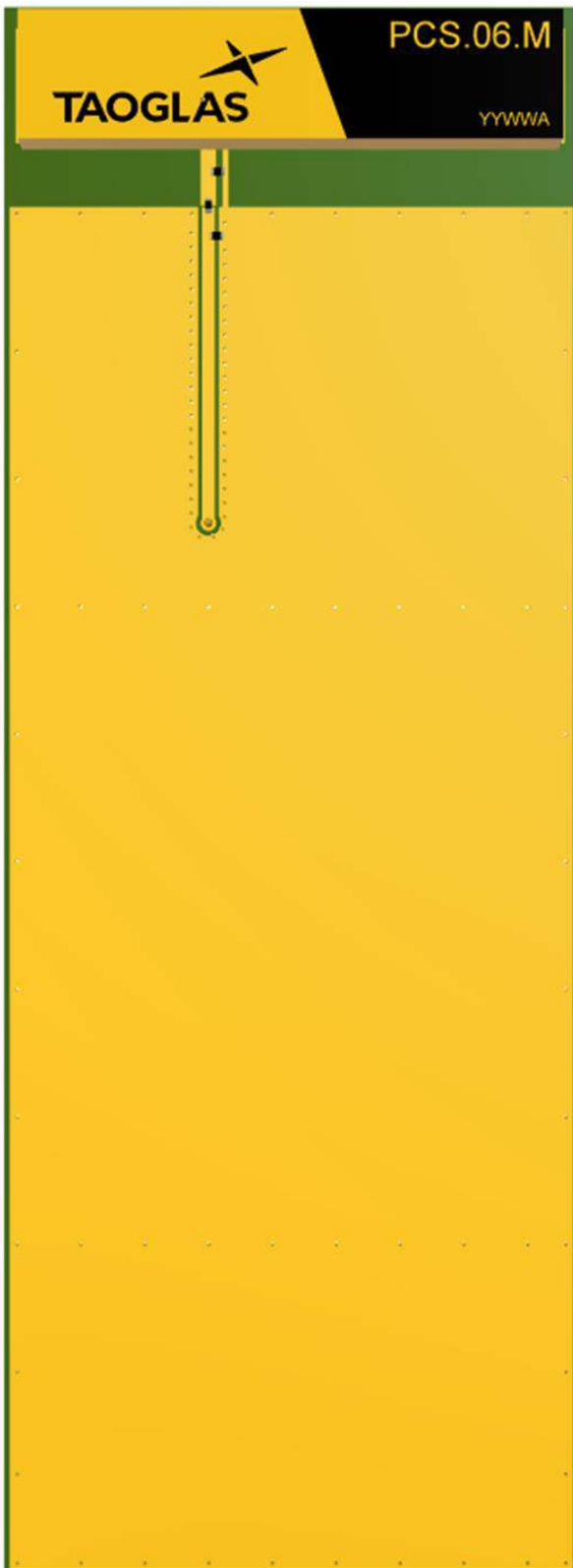

Ground Plane Length
107mm

6.7 Evaluation Board Matching Circuit

A matching component (L1) in parallel with the PCS.06.M is required for the antenna to have optimal performance on the evaluation board, located outside of the ground plane in the space specified in the above images. C1 is also required as a matching component for this antenna. C1 is positioned sitting across the ground plane as shown in the above images. Additional matching components may be necessary for your device, so we recommend incorporating extra component footprints, forming a “pi” network, between the cellular module and the edge of the ground plane.

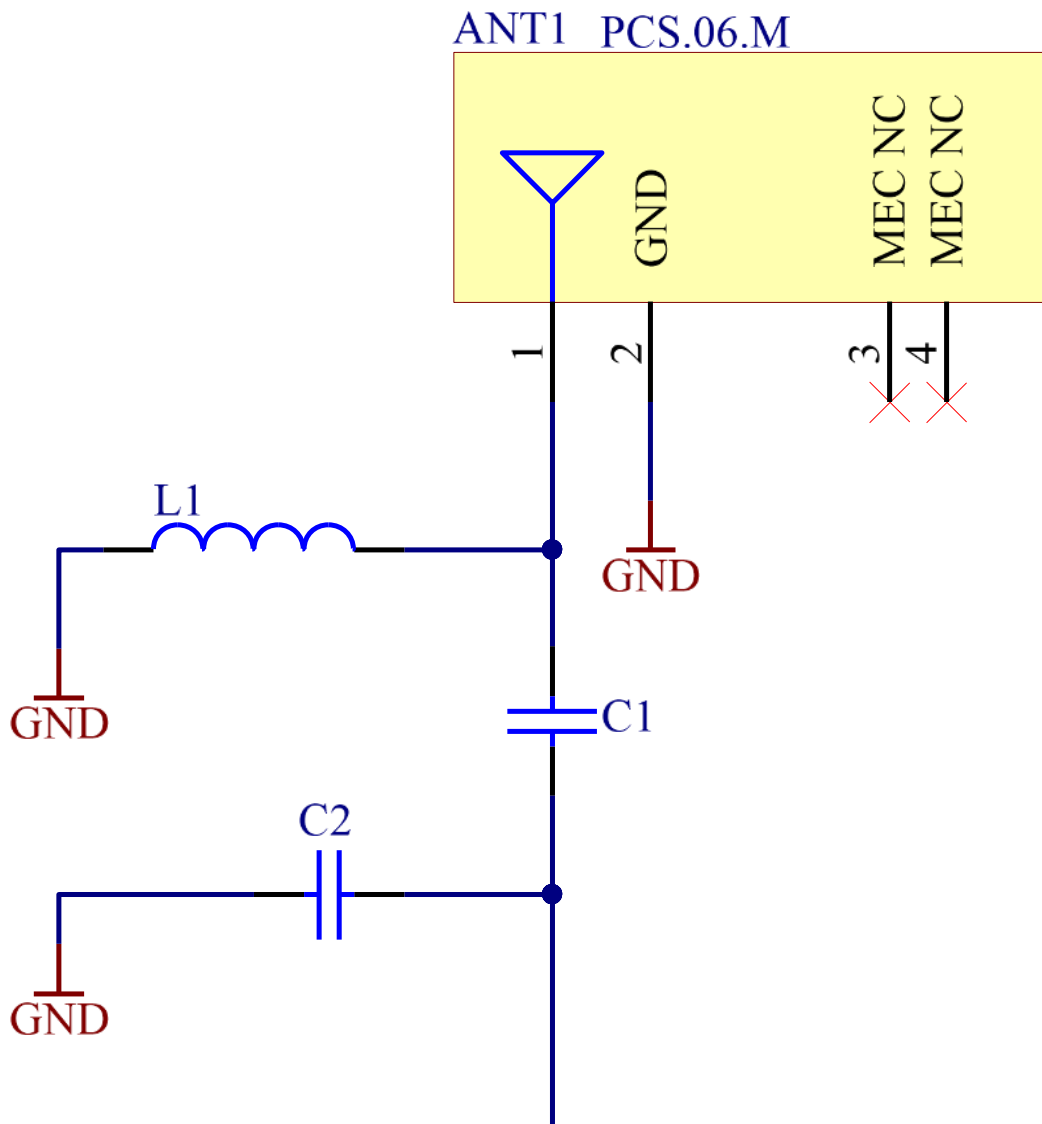

Designator	Type	Value	Description
L1	Inductor	6.8nH	TDK: MLK1005S Series
C1	Capacitor	6.8pF	Murata:GRM1555 Series
C2	Capacitor	Not Fitted	

6.8 Footprint

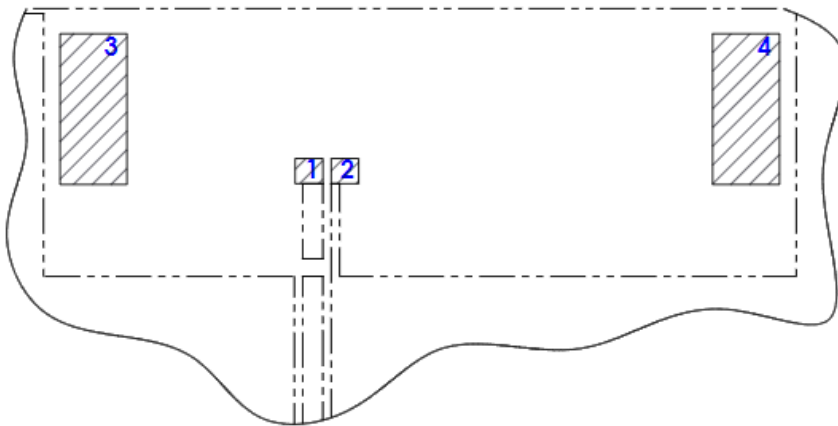

FOOTPRINT SOLDER PADS WITH PCB OUTLINE
SCALE 3:1

PIN	DESCRIPTION:
1	RF FEED (50 Ohm)
2	GROUND
3	MECHANICAL/NOT CONNECTED
4	MECHANICAL/NOT CONNECTED

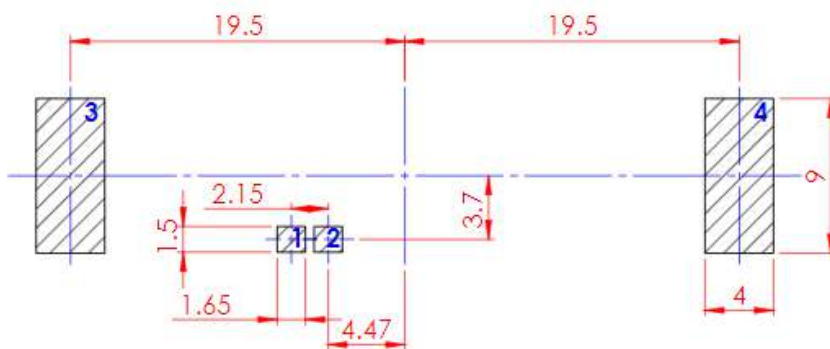

FOOTPRINT PCB
SCALE 3:1

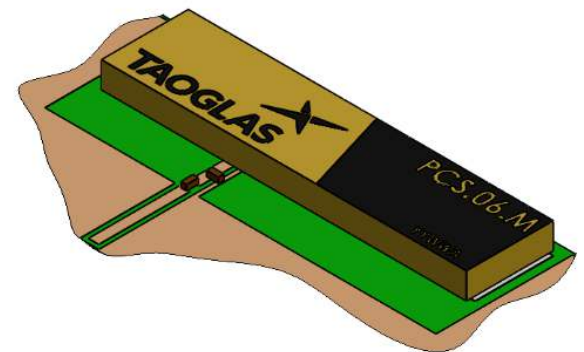

ANTENNA ON FOOTPRINT PCB VIEW
SCALE 3:1

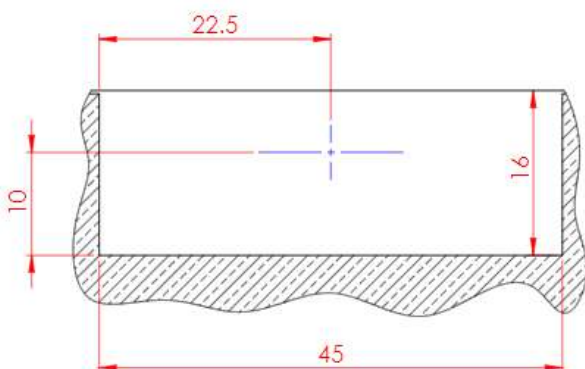

GROUND CLEARANCE BOTTOM VIEW
(SILKSCREEN NOT SHOWN)
SCALE 2:1

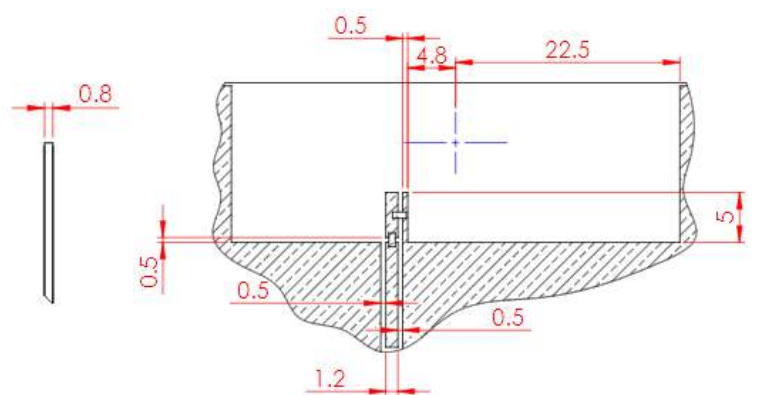

GROUND CLEARANCE TOP VIEW
(SILKSCREEN NOT SHOWN)
SCALE 2:1

7. Packaging

1000 pcs PCS.06.M reel
 Dimensions - 330*330*60mm
 Weight -3230g

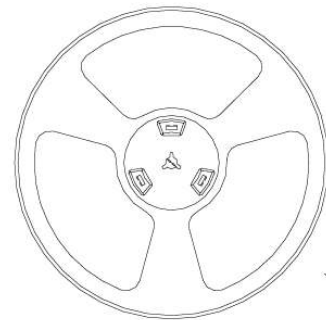

1000 pcs PCS.06.M / 1 Reel in small box
 Dimensions - 340*340*90mm
 Weight -3.5Kg

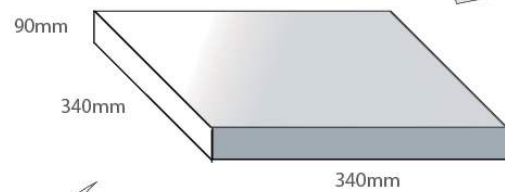

3 reels, 3000 pcs in one carton
 Carton Dimensions - 370*360*275mm
 Weight -11.3Kg

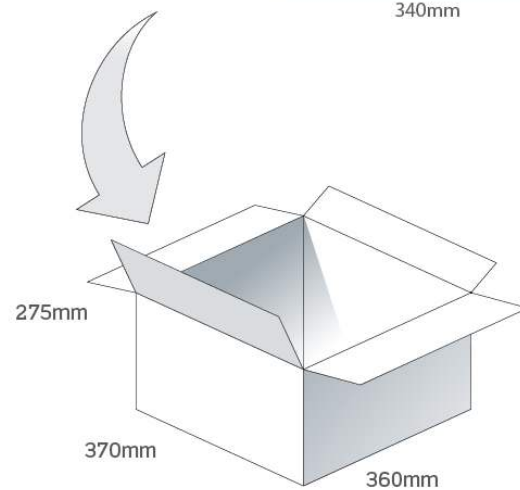

Changelog for the datasheet

SPE-20-8-122 – PCS.06.M

Revision: C (Current Version)

Date:	2022-09-21
Notes:	Updated Mechanical drawings.
Author:	Gary West

Previous Revisions

Revision: B

Date:	2021-11-19
Notes:	Updated data with golden sample test data & added integration guide.
Author:	Gary West

Revision: A (Original First Release)

Date:	2020-12-04
Notes:	
Author:	Jack Conroy



TAOGLAS®

www.taoglas.com

