



SIRIUS soft starter 200-480 V 63 A, 110-250 V AC Screw terminals  
Thermistor input











<b>product brand name</b>	SIRIUS
<b>product category</b>	Hybrid switching devices
<b>product designation</b>	Soft starter
<b>product type designation</b>	3RW52
<b>manufacturer's article number</b>	<ul style="list-style-type: none"> <li>• of standard HMI module usable <a href="#">3RW5980-0HS00</a></li> <li>• of high feature HMI module usable <a href="#">3RW5980-0HF00</a></li> <li>• of communication module PROFINET standard usable <a href="#">3RW5980-0CS00</a></li> <li>• of communication module PROFIBUS usable <a href="#">3RW5980-0CP00</a></li> <li>• of communication module Modbus TCP usable <a href="#">3RW5980-0CT00</a></li> <li>• of communication module Modbus RTU usable <a href="#">3RW5980-0CR00</a></li> <li>• of communication module Ethernet/IP <a href="#">3RW5980-0CE00</a></li> <li>• of circuit breaker usable at 400 V <a href="#">3VA2163-7MN32-0AA0: Type of coordination 1, Iq = 65 kA, CLASS 10</a></li> <li>• of circuit breaker usable at 500 V <a href="#">3VA2163-7MN32-0AA0: Type of coordination 1, Iq = 20 kA, CLASS 10</a></li> <li>• of circuit breaker usable at 400 V at inside-delta circuit <a href="#">3VA2110-7MN32-0AA0: Type of coordination 1, Iq = 65 kA, CLASS 10</a></li> <li>• of circuit breaker usable at 500 V at inside-delta circuit <a href="#">3VA2110-7MN32-0AA0: Type of coordination 1, Iq = 20 kA, CLASS 10</a></li> <li>• of the gG fuse usable up to 690 V <a href="#">3NA3830-6: Type of coordination 1, Iq = 65 kA</a></li> <li>• of the gG fuse usable at inside-delta circuit up to 500 V <a href="#">3NA3830-6: Type of coordination 1, Iq = 65 kA</a></li> <li>• of full range R fuse link for semiconductor protection usable up to 690 V <a href="#">3NE1022-0: Type of coordination 2, Iq = 65 kA</a></li> <li>• of back-up R fuse link for semiconductor protection usable up to 690 V <a href="#">3NE8024-1: Type of coordination 2, Iq = 65 kA</a></li> </ul>
<b>General technical data</b>	
<b>starting voltage [%]</b>	30 ... 100 %
<b>stopping voltage [%]</b>	50 %; non-adjustable
<b>start-up ramp time of soft starter</b>	0 ... 20 s
<b>current limiting value [%] adjustable</b>	130 ... 700 %
<b>certificate of suitability</b>	<ul style="list-style-type: none"> <li>• CE marking Yes</li> <li>• UL approval Yes</li> <li>• CSA approval Yes</li> </ul>
<b>product component</b>	<ul style="list-style-type: none"> <li>• HMI-High Feature No</li> <li>• is supported HMI-Standard Yes</li> <li>• is supported HMI-High Feature Yes</li> </ul>
<b>product feature integrated bypass contact system</b>	Yes
<b>number of controlled phases</b>	3

<b>trip class</b>	CLASS 10A (default) / 10E / 20E; acc. to IEC 60947-4-2
<b>buffering time in the event of power failure</b>	
• for main current circuit	100 ms
• for control circuit	100 ms
insulation voltage rated value	600 V
<b>degree of pollution</b>	3, acc. to IEC 60947-4-2
<b>impulse voltage rated value</b>	6 kV
<b>blocking voltage of the thyristor maximum</b>	1 400 V
<b>service factor</b>	1
<b>surge voltage resistance rated value</b>	6 kV
<b>maximum permissible voltage for safe isolation</b>	
• between main and auxiliary circuit	600 V
<b>shock resistance</b>	15 g / 11 ms, from 12 g / 11 ms with potential contact lifting
<b>vibration resistance</b>	15 mm to 6 Hz; 2g to 500 Hz
utilization category according to IEC 60947-4-2	AC 53a
<b>reference code according to IEC 81346-2</b>	Q
<b>Substance Prohibitance (Date)</b>	02/15/2018
<b>product function</b>	
• ramp-up (soft starting)	Yes
• ramp-down (soft stop)	Yes
• Soft Torque	Yes
• adjustable current limitation	Yes
• pump ramp down	Yes
• intrinsic device protection	Yes
• motor overload protection	Yes; Full motor protection (thermistor motor protection and electronic motor overload protection)
• evaluation of thermistor motor protection	Yes; Type A PTC or Klixon / Thermoclick
• inside-delta circuit	Yes
• auto-RESET	Yes
• manual RESET	Yes
• remote reset	Yes; By turning off the control supply voltage
• communication function	Yes
• operating measured value display	Yes; Only in conjunction with special accessories
• error logbook	Yes; Only in conjunction with special accessories
• via software parameterizable	No
• via software configurable	Yes
• <b>PROFenergy</b>	Yes; in connection with the PROFINET Standard communication module
• <b>firmware update</b>	Yes
• <b>removable terminal for control circuit</b>	Yes
• torque control	No
• analog output	No
<b>Power Electronics</b>	
<b>operational current</b>	
• at 40 °C rated value	63 A
• at 50 °C rated value	56 A
• at 60 °C rated value	51 A
<b>operational current at inside-delta circuit</b>	
• at 40 °C rated value	109 A
• at 50 °C rated value	96 A
• at 60 °C rated value	87.5 A
<b>operating voltage</b>	
• rated value	200 ... 480 V
• at inside-delta circuit rated value	200 ... 480 V
<b>relative negative tolerance of the operating voltage</b>	-15 %
<b>relative positive tolerance of the operating voltage</b>	10 %
<b>relative negative tolerance of the operating voltage at inside-delta circuit</b>	-15 %
<b>relative positive tolerance of the operating voltage at inside-delta circuit</b>	10 %
<b>operating power for 3-phase motors</b>	

<ul style="list-style-type: none"> <li>• at 230 V at 40 °C rated value</li> </ul>	18.5 kW
<ul style="list-style-type: none"> <li>• at 230 V at inside-delta circuit at 40 °C rated value</li> </ul>	30 kW
<ul style="list-style-type: none"> <li>• at 400 V at 40 °C rated value</li> </ul>	30 kW
<ul style="list-style-type: none"> <li>• at 400 V at inside-delta circuit at 40 °C rated value</li> </ul>	55 kW
<b>Operating frequency 1 rated value</b>	50 Hz
<b>Operating frequency 2 rated value</b>	60 Hz
<b>relative negative tolerance of the operating frequency</b>	-10 %
<b>relative positive tolerance of the operating frequency</b>	10 %
<b>adjustable motor current</b>	
<ul style="list-style-type: none"> <li>• at rotary coding switch on switch position 1</li> </ul>	25.5 A
<ul style="list-style-type: none"> <li>• at rotary coding switch on switch position 2</li> </ul>	28 A
<ul style="list-style-type: none"> <li>• at rotary coding switch on switch position 3</li> </ul>	30.5 A
<ul style="list-style-type: none"> <li>• at rotary coding switch on switch position 4</li> </ul>	33 A
<ul style="list-style-type: none"> <li>• at rotary coding switch on switch position 5</li> </ul>	35.5 A
<ul style="list-style-type: none"> <li>• at rotary coding switch on switch position 6</li> </ul>	38 A
<ul style="list-style-type: none"> <li>• at rotary coding switch on switch position 7</li> </ul>	40.5 A
<ul style="list-style-type: none"> <li>• at rotary coding switch on switch position 8</li> </ul>	43 A
<ul style="list-style-type: none"> <li>• at rotary coding switch on switch position 9</li> </ul>	45.5 A
<ul style="list-style-type: none"> <li>• at rotary coding switch on switch position 10</li> </ul>	48 A
<ul style="list-style-type: none"> <li>• at rotary coding switch on switch position 11</li> </ul>	50.5 A
<ul style="list-style-type: none"> <li>• at rotary coding switch on switch position 12</li> </ul>	53 A
<ul style="list-style-type: none"> <li>• at rotary coding switch on switch position 13</li> </ul>	55.5 A
<ul style="list-style-type: none"> <li>• at rotary coding switch on switch position 14</li> </ul>	58 A
<ul style="list-style-type: none"> <li>• at rotary coding switch on switch position 15</li> </ul>	60.5 A
<ul style="list-style-type: none"> <li>• at rotary coding switch on switch position 16</li> </ul>	63 A
<ul style="list-style-type: none"> <li>• minimum</li> </ul>	25.5 A
<b>adjustable motor current</b>	
<ul style="list-style-type: none"> <li>• for inside-delta circuit at rotary coding switch on switch position 1</li> </ul>	44.2 A
<ul style="list-style-type: none"> <li>• for inside-delta circuit at rotary coding switch on switch position 2</li> </ul>	48.5 A
<ul style="list-style-type: none"> <li>• for inside-delta circuit at rotary coding switch on switch position 3</li> </ul>	52.8 A
<ul style="list-style-type: none"> <li>• for inside-delta circuit at rotary coding switch on switch position 4</li> </ul>	57.2 A
<ul style="list-style-type: none"> <li>• for inside-delta circuit at rotary coding switch on switch position 5</li> </ul>	61.5 A
<ul style="list-style-type: none"> <li>• for inside-delta circuit at rotary coding switch on switch position 6</li> </ul>	65.8 A
<ul style="list-style-type: none"> <li>• for inside-delta circuit at rotary coding switch on switch position 7</li> </ul>	70.1 A
<ul style="list-style-type: none"> <li>• for inside-delta circuit at rotary coding switch on switch position 8</li> </ul>	74.5 A
<ul style="list-style-type: none"> <li>• for inside-delta circuit at rotary coding switch on switch position 9</li> </ul>	78.8 A
<ul style="list-style-type: none"> <li>• for inside-delta circuit at rotary coding switch on switch position 10</li> </ul>	83.1 A
<ul style="list-style-type: none"> <li>• for inside-delta circuit at rotary coding switch on switch position 11</li> </ul>	87.5 A
<ul style="list-style-type: none"> <li>• for inside-delta circuit at rotary coding switch on switch position 12</li> </ul>	91.8 A
<ul style="list-style-type: none"> <li>• for inside-delta circuit at rotary coding switch on switch position 13</li> </ul>	96.1 A
<ul style="list-style-type: none"> <li>• for inside-delta circuit at rotary coding switch on switch position 14</li> </ul>	100 A
<ul style="list-style-type: none"> <li>• for inside-delta circuit at rotary coding switch on switch position 15</li> </ul>	105 A
<ul style="list-style-type: none"> <li>• for inside-delta circuit at rotary coding switch on switch position 16</li> </ul>	109 A
<ul style="list-style-type: none"> <li>• at inside-delta circuit minimum</li> </ul>	44.2 A
<b>minimum load [%]</b>	15 %; Relative to smallest settable le
<b>power loss [W] for rated value of the current at AC</b>	
<ul style="list-style-type: none"> <li>• at 40 °C after startup</li> </ul>	31 W
<ul style="list-style-type: none"> <li>• at 50 °C after startup</li> </ul>	29 W

<ul style="list-style-type: none"> <li>• at 60 °C after startup</li> </ul>	27 W
<b>power loss [W] at AC at current limitation 350 %</b>	
<ul style="list-style-type: none"> <li>• at 40 °C during startup</li> </ul>	882 W
<ul style="list-style-type: none"> <li>• at 50 °C during startup</li> </ul>	744 W
<ul style="list-style-type: none"> <li>• at 60 °C during startup</li> </ul>	659 W
<b>Control circuit/ Control</b>	
<b>type of voltage of the control supply voltage</b>	AC
<b>control supply voltage at AC</b>	
<ul style="list-style-type: none"> <li>• at 50 Hz</li> </ul>	110 ... 250 V
<ul style="list-style-type: none"> <li>• at 60 Hz</li> </ul>	110 ... 250 V
<b>relative negative tolerance of the control supply voltage at AC at 50 Hz</b>	-15 %
<b>relative positive tolerance of the control supply voltage at AC at 50 Hz</b>	10 %
<b>relative negative tolerance of the control supply voltage at AC at 60 Hz</b>	-15 %
<b>relative positive tolerance of the control supply voltage at AC at 60 Hz</b>	10 %
<b>control supply voltage frequency</b>	50 ... 60 Hz
<b>relative negative tolerance of the control supply voltage frequency</b>	-10 %
<b>relative positive tolerance of the control supply voltage frequency</b>	10 %
<b>control supply current in standby mode rated value</b>	30 mA
<b>holding current in bypass operation rated value</b>	75 mA
<b>locked-rotor current at close of bypass contact maximum</b>	2.5 A
<b>inrush current peak at application of control supply voltage maximum</b>	12.2 A
<b>duration of inrush current peak at application of control supply voltage</b>	2.2 ms
<b>design of the overvoltage protection</b>	Varistor
<b>design of short-circuit protection for control circuit</b>	4 A gG fuse (I <sub>cu</sub> =1 kA), 6 A quick-acting fuse (I <sub>cu</sub> =1 kA), C1 miniature circuit breaker (I <sub>cu</sub> = 600 A), C6 miniature circuit breaker (I <sub>cu</sub> = 300 A); Is not part of scope of supply
<b>Inputs/ Outputs</b>	
<b>number of digital inputs</b>	1
<b>number of digital outputs</b>	3
<ul style="list-style-type: none"> <li>• not parameterizable</li> </ul>	2
<b>digital output version</b>	2 normally-open contacts (NO) / 1 changeover contact (CO)
<b>number of analog outputs</b>	0
<b>switching capacity current of the relay outputs</b>	
<ul style="list-style-type: none"> <li>• at AC-15 at 250 V rated value</li> </ul>	3 A
<ul style="list-style-type: none"> <li>• at DC-13 at 24 V rated value</li> </ul>	1 A
<b>Installation/ mounting/ dimensions</b>	
<b>mounting position</b>	+/- 10° rotation possible and can be tilted forward or backward on vertical mounting surface
<b>fastening method</b>	screw fixing
<b>height</b>	306 mm
<b>width</b>	185 mm
<b>depth</b>	203 mm
<b>required spacing with side-by-side mounting</b>	
<ul style="list-style-type: none"> <li>• forwards</li> </ul>	10 mm
<ul style="list-style-type: none"> <li>• backwards</li> </ul>	0 mm
<ul style="list-style-type: none"> <li>• upwards</li> </ul>	100 mm
<ul style="list-style-type: none"> <li>• downwards</li> </ul>	75 mm
<ul style="list-style-type: none"> <li>• at the side</li> </ul>	5 mm
<b>weight without packaging</b>	5.6 kg
<b>Connections/ Terminals</b>	
<b>type of electrical connection</b>	
<ul style="list-style-type: none"> <li>• for main current circuit</li> </ul>	box terminal
<ul style="list-style-type: none"> <li>• for control circuit</li> </ul>	screw-type terminals

<b>width of connection bar maximum</b>	25 mm
<b>wire length for thermistor connection</b>	
<ul style="list-style-type: none"> <li>with conductor cross-section = 0.5 mm<sup>2</sup> maximum</li> </ul>	50 m
<ul style="list-style-type: none"> <li>with conductor cross-section = 1.5 mm<sup>2</sup> maximum</li> </ul>	150 m
<ul style="list-style-type: none"> <li>with conductor cross-section = 2.5 mm<sup>2</sup> maximum</li> </ul>	250 m
<b>type of connectable conductor cross-sections</b>	
<ul style="list-style-type: none"> <li>for main contacts for box terminal using the front clamping point solid</li> </ul>	1x (2.5 ... 16 mm <sup>2</sup> )
<ul style="list-style-type: none"> <li>for main contacts for box terminal using the front clamping point finely stranded with core end processing</li> </ul>	1x (2.5 ... 50 mm <sup>2</sup> )
<ul style="list-style-type: none"> <li>for main contacts for box terminal using the front clamping point stranded</li> </ul>	1x (10 ... 70 mm <sup>2</sup> )
<ul style="list-style-type: none"> <li>at AWG cables for main contacts for box terminal using the front clamping point</li> </ul>	1x (10 ... 2/0)
<ul style="list-style-type: none"> <li>for main contacts for box terminal using the back clamping point solid</li> </ul>	1x (2.5 ... 16 mm <sup>2</sup> )
<ul style="list-style-type: none"> <li>at AWG cables for main contacts for box terminal using the back clamping point</li> </ul>	1x (10 ... 2/0)
<ul style="list-style-type: none"> <li>for main contacts for box terminal using both clamping points solid</li> </ul>	2x (2.5 ... 16 mm <sup>2</sup> )
<ul style="list-style-type: none"> <li>for main contacts for box terminal using both clamping points finely stranded with core end processing</li> </ul>	2x (2.5 ... 35 mm <sup>2</sup> )
<ul style="list-style-type: none"> <li>for main contacts for box terminal using both clamping points stranded</li> </ul>	2x (6 ... 16 mm <sup>2</sup> ), 2x (10 ... 50 mm <sup>2</sup> )
<ul style="list-style-type: none"> <li>for main contacts for box terminal using the back clamping point finely stranded with core end processing</li> </ul>	1x (2.5 ... 50 mm <sup>2</sup> )
<ul style="list-style-type: none"> <li>for main contacts for box terminal using the back clamping point stranded</li> </ul>	1x (10 ... 70 mm <sup>2</sup> )
<b>type of connectable conductor cross-sections</b>	
<ul style="list-style-type: none"> <li>for control circuit solid</li> </ul>	1x (0.5 ... 4.0 mm <sup>2</sup> ), 2x (0.5 ... 2.5 mm <sup>2</sup> )
<ul style="list-style-type: none"> <li>for control circuit finely stranded with core end processing</li> </ul>	1x (0.5 ... 2.5 mm <sup>2</sup> ), 2x (0.5 ... 1.5 mm <sup>2</sup> )
<ul style="list-style-type: none"> <li>at AWG cables for control circuit solid</li> </ul>	1x (20 ... 12), 2x (20 ... 14)
<b>wire length</b>	
<ul style="list-style-type: none"> <li>between soft starter and motor maximum</li> </ul>	800 m
<ul style="list-style-type: none"> <li>at the digital inputs at AC maximum</li> </ul>	100 m
<b>tightening torque</b>	
<ul style="list-style-type: none"> <li>for main contacts with screw-type terminals</li> </ul>	4.5 ... 6 N·m
<ul style="list-style-type: none"> <li>for auxiliary and control contacts with screw-type terminals</li> </ul>	0.8 ... 1.2 N·m
<b>tightening torque [lbf·in]</b>	
<ul style="list-style-type: none"> <li>for main contacts with screw-type terminals</li> </ul>	40 ... 53 lbf·in
<ul style="list-style-type: none"> <li>for auxiliary and control contacts with screw-type terminals</li> </ul>	7 ... 10.3 lbf·in
<b>Ambient conditions</b>	
installation altitude at height above sea level maximum	5 000 m; Derating as of 1000 m, see catalog
<b>ambient temperature</b>	
<ul style="list-style-type: none"> <li>during operation</li> </ul>	-25 ... +60 °C; Please observe derating at temperatures of 40 °C or above
<ul style="list-style-type: none"> <li>during storage and transport</li> </ul>	-40 ... +80 °C
<b>environmental category</b>	
<ul style="list-style-type: none"> <li>during operation according to IEC 60721</li> </ul>	3K6 (no ice formation, only occasional condensation), 3C3 (no salt mist), 3S2 (sand must not get into the devices), 3M6
<ul style="list-style-type: none"> <li>during storage according to IEC 60721</li> </ul>	1K6 (only occasional condensation), 1C2 (no salt mist), 1S2 (sand must not get inside the devices), 1M4
<ul style="list-style-type: none"> <li>during transport according to IEC 60721</li> </ul>	2K2, 2C1, 2S1, 2M2 (max. fall height 0.3 m)
<b>EMC emitted interference</b>	acc. to IEC 60947-4-2: Class A
<b>Communication/ Protocol</b>	
<b>communication module is supported</b>	
<ul style="list-style-type: none"> <li>PROFINET standard</li> </ul>	Yes
<ul style="list-style-type: none"> <li>EtherNet/IP</li> </ul>	Yes
<ul style="list-style-type: none"> <li>Modbus RTU</li> </ul>	Yes

<ul style="list-style-type: none"> <li>• Modbus TCP</li> <li>• PROFIBUS</li> </ul>	<p>Yes</p> <p>Yes</p>				
<b>UL/CSA ratings</b>					
<b>manufacturer's article number</b>					
<ul style="list-style-type: none"> <li>• <b>of circuit breaker</b> <ul style="list-style-type: none"> <li>— usable for Standard Faults at 460/480 V according to UL</li> <li>— usable for High Faults at 460/480 V according to UL</li> <li>— usable for Standard Faults at 460/480 V at inside-delta circuit according to UL</li> <li>— usable for High Faults at 460/480 V at inside-delta circuit according to UL</li> <li>— usable for Standard Faults at 575/600 V according to UL</li> <li>— usable for Standard Faults at 575/600 V at inside-delta circuit according to UL</li> </ul> </li> <li>• <b>of the fuse</b> <ul style="list-style-type: none"> <li>— usable for Standard Faults up to 575/600 V according to UL</li> <li>— usable for High Faults up to 575/600 V according to UL</li> <li>— usable for Standard Faults at inside-delta circuit up to 575/600 V according to UL</li> <li>— usable for High Faults at inside-delta circuit up to 575/600 V according to UL</li> </ul> </li> </ul>	<p>Siemens type: 3RV2742, max. 70 A or 3VA51, max. 125 A; Iq = 10 kA</p> <p>Siemens type: 3VA51, max. 125 A; Iq max = 65 kA</p> <p>Siemens type: 3VA51, max. 125 A; Iq = 10 kA</p> <p>Siemens type: 3VA51, max. 125 A; Iq max = 65 kA</p> <p>Siemens type: 3RV2742, max. 70 A or 3VA51, max. 125 A; Iq = 10 kA</p> <p>Siemens type: 3VA51, max. 125 A; Iq = 10 kA</p> <p>Type: Class RK5 / K5, max. 200 A; Iq = 10 kA</p> <p>Type: Class J / L, max. 225 A; Iq = 100 kA</p> <p>Type: Class RK5 / K5, max. 200 A; Iq = 10 kA</p> <p>Type: Class J / L, max. 225 A; Iq = 100 kA</p>				
<b>operating power [hp] for 3-phase motors</b>					
<ul style="list-style-type: none"> <li>• at 200/208 V at 50 °C rated value</li> <li>• at 220/230 V at 50 °C rated value</li> <li>• at 460/480 V at 50 °C rated value</li> <li>• at 200/208 V at inside-delta circuit at 50 °C rated value</li> <li>• at 220/230 V at inside-delta circuit at 50 °C rated value</li> <li>• at 460/480 V at inside-delta circuit at 50 °C rated value</li> </ul>	<p>15 hp</p> <p>20 hp</p> <p>40 hp</p> <p>30 hp</p> <p>30 hp</p> <p>75 hp</p>				
<b>contact rating of auxiliary contacts according to UL</b>	R300-B300				
<b>Safety related data</b>					
<b>protection class IP on the front according to IEC 60529</b>	IP00; IP20 with cover				
<b>touch protection on the front according to IEC 60529</b>	finger-safe, for vertical contact from the front with cover				
<b>electromagnetic compatibility</b>	in accordance with IEC 60947-4-2				
<b>Certificates/ approvals</b>					
<b>General Product Approval</b>	<b>EMC</b>				
	<a href="#">Confirmation</a>				
<b>Declaration of Conformity</b>	<b>Test Certificates</b>	<b>Marine / Shipping</b>			
		<a href="#">Type Test Certificates/Test Report</a>			
<b>Marine / Shipping</b>	<b>other</b>				



Further information

Information- and Downloadcenter (Catalogs, Brochures,...)

<https://www.siemens.com/ic10>

Industry Mall (Online ordering system)

<https://mall.industry.siemens.com/mall/en/en/Catalog/product?mlfb=3RW5225-1TC14>

Cax online generator

<http://support.automation.siemens.com/WW/CAXorder/default.aspx?lang=en&mlfb=3RW5225-1TC14>

Service&Support (Manuals, Certificates, Characteristics, FAQs,...)

<https://support.industry.siemens.com/cs/ww/en/ps/3RW5225-1TC14>

Image database (product images, 2D dimension drawings, 3D models, device circuit diagrams, EPLAN macros, ...)

[http://www.automation.siemens.com/bilddb/cax\\_de.aspx?mlfb=3RW5225-1TC14&lang=en](http://www.automation.siemens.com/bilddb/cax_de.aspx?mlfb=3RW5225-1TC14&lang=en)

Characteristic: Tripping characteristics, I<sup>2</sup>t, Let-through current

<https://support.industry.siemens.com/cs/ww/en/ps/3RW5225-1TC14/char>

Characteristic: Installation altitude

<http://www.automation.siemens.com/bilddb/index.aspx?view=Search&mlfb=3RW5225-1TC14&objecttype=14&gridview=view1>

Simulation Tool for Soft Starters (STS)

<https://support.industry.siemens.com/cs/ww/en/view/101494917>

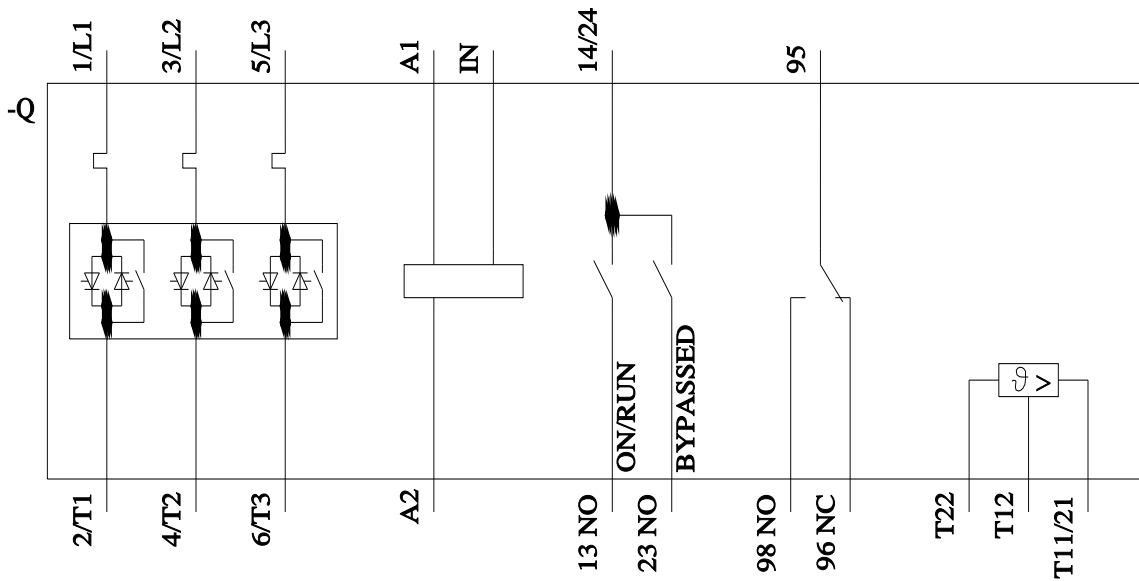

last modified:

4/10/2022

