

QUICK START GUIDE FOR DEMONSTRATION CIRCUIT 479

ISOLATED SYNCHRONOUS FORWARD CONVERTER—QUARTER BRICK

LT3781 and LTC1698

DESCRIPTION

Demonstration circuit 479 is an isolated synchronous forward converter featuring the LT3781 and LTC1698 controllers. DC479 is designed to be a board level replacement for "quarter-brick" DC/DC converters. The design can provide 3.3V at 15A from an isolated 48V (36V to 72V) input. Isolation voltage is 1500V DC. The circuit features low input capacitance, over temperature protection, soft start with input undervoltage and overvoltage

lockout. Cycling short circuit protection minimizes thermal stress. The output overvoltage circuit provides protection for the load should a fault occur on the sense lines. The standard footprint allows for immediate on board evaluation by plugging directly into the modules' socket.

Design files for this circuit board are available. Call the LTC factory.

Table 1. Performance Summary. $T_A = 25^\circ\text{C}$, $V_{IN} = 48\text{V}$, full load, ON/OFF and TRIM pins open, +SENSE shorted to +VOUT, -SENSE shorted to -VOUT, unless otherwise specified.

PARAMETER	CONDITION	MIN	TYP	MAX	UNITS
Input Voltage Range		36	48	72	V
Maximum Input Current	$V_{IN} = 36\text{V}$, Full Load		1.6		A
Inrush Transient	$V_{IN} = 72\text{V}$			0.2	A ² s
Reflected Ripple Current			100		mA _{P-P}
Output Voltage		3.24	3.30	3.36	V
Output Regulation	Line			0.1	%
	Load			0.2	%
Output Current				15	A
Output Current Limit			18		A
Output Short Circuit	Cycling, Auto-restart		1000		ms
Output Ripple and Noise	RMS		15		mV _{RMS}
	Peak-to-peak (5Hz to 20MHz)		40	60	mV _{P-P}
Efficiency			88.5		%
Dynamic Response	Peak Deviation		50	100	mV
Load Step 50% to 100%	Settling Time (to within 10mV of set point)		100	200	μs
Output Voltage Trim	$V_{TRIM} = 3.3\text{V}$	4	5	6	%
	$V_{TRIM} = 0\text{V}$	-6	-5	-4	%
Output Overvoltage			3.65		V
On/Off Control	Logic Low Voltage: Off	0		0.6	V
	Logic High Voltage: On	1.0			V
	Logic Low Current : Off		0.2		mA
	Quiescent Current: Off		1.4		mA
	Start-up Inhibit Period		7.5		ms
	Turn on Time		10	15	ms

QUICK START GUIDE FOR DEMONSTRATION CIRCUIT 479

ISOLATED SYNCHRONOUS FORWARD CONVERTER—QUARTER BRICK

PARAMETER	CONDITION	MIN	TYP	MAX	UNITS
Thermal Shutdown	At RT1		100		°C
Isolation Voltage				1500	V DC
Isolation Resistance		10			MΩ
Isolation Capacitance			2200		pF

OPERATING PRINCIPLES

CIRCUIT OVERVIEW

This two-transistor forward converter operates at a nominal switching frequency of 240 kHz. Pulse width modulation control is done by U3, the LT3781 synchronous forward controller. Galvanic isolation is met with transformer T1 and optocoupler ISO1. C10 is used as a local bypass to reduce common mode induced current.

The main switching power path through T1 is comprised of L1, C2 and C3 as the input filter, with Q1 and Q3 as the primary switches. MOSFETs Q4, 5, 6, and 7 are the secondary synchronous rectifiers. L3 and C4-7 are the secondary output filter. Power is transferred during the on cycle of Q1 and Q3, and integrated by the output filter, just as in a buck regulator. D1 and D2 recover energy stored in the leakage inductance of T1 during the off cycle. The input filter component values for L1, C2 and C3 are optimal and should not be changed without careful evaluation. C1 bypasses the input terminals. For large values of input inductance, an external aluminum electrolytic capacitor will damp the input filter and provide adequate stability. See Linear Technology's application note AN19 for a discussion on input filter stability analysis.

When the primary switches turn off, the transformer voltage reverses, with D1 and D2 conducting to reset the transformer during normal operation. A startup or transient to no load can cause the pulse width modulation to narrow, with insufficient energy to force the reset diodes into conduction. When this occurs, the charge on C20 gets depleted and the top gate drive shuts off. This will result in the converter cycling on and off. To overcome this, Q10 provides a return path to refresh the top gate boost capacitor C20.

Feedback control of the output voltage and synchronous drive is done using U1, the LTC1698. The LTC1698 syn-

chronizes with the LT3781 via T2, a small pulse transformer. The LTC1698 includes an error amplifier and optocoupler drive buffer, eliminating the output feed-forward path associated with '431 type references. U1 also provides output overvoltage protection. The margin pin allows the output voltage to be adjusted $\pm 5\%$.

During an output short circuit condition, the primary bias supply at Vcc collapses. This results in the converter harmlessly cycling on and off, keeping power dissipation to a minimum. The cycling rate is nominally 1Hz with 48V input. When the short is removed, the converter returns to normal operation.

The demo board uses all surface mount devices and will deliver the full rated current at room temperature. With elevated temperature operation, airflow is required for full rated load. The demo board features thermal overload protection.

For -48V inputs requiring hot swap capability, the LT4250H negative voltage hot swap controller provides a seamless interface.

OPTIONAL FAST START CIRCUIT

When power is first applied, Vcc must rise to 15V for the LT3781 to turn on. The bias supply turn on threshold and hysteresis are set internally by U3. R8 and 9 charge the 100μF capacitor C25, and are gated by Q9. With 200Ω resistance, the charge time is 7.5ms at 48V in. The values for R8 and R9 can be adjusted in order to change the turn on delay. Values lower than 100Ω for each resistor will result in abnormally high peak power, and possible component failure. Once the LT3781 turns on, the 5Vref charges C12 causing Q11 to turn off Q9. Bias supply power is delivered through L2 by a winding on T1. In the event of an output short circuit, the voltage on the transformer bias winding collapses. Restart

time is determined by C12 and R15, and is set to approximately 1 second.

The optional fast start circuit can be removed, and a 20kΩ resistor installed for R25. The peak bias supply voltage is self limiting by an internal 18V clamp on the LT3781 Vcc pin. R25 will trickle charge C25, resulting in a turn on delay of approximately 750ms at 48V in.

OPTIONAL DIFFERENTIAL SENSE

The LT1783 operational amplifier U1 provides true differential remote sense. If this feature is not required the circuit can be removed. To maintain voltage regulation, a zero ohm resistor must be installed for R28.

FORWARD CONVERTER DESIGN EQUATIONS

The two-transistor forward converter is a good choice for 48V telecom applications. The maximum duty cycle is limited to 50% with the two-transistor forward. This topology is used quite extensively in many modular designs. Unlike the flyback, energy is not intentionally stored in the power transformer. This allows for a much smaller transformer design.

The forward converter has pulsating current in the input capacitor, and continuous current in the output capacitor. Worst case ripple current for the input capacitor occurs at 50% duty cycle. Two 0.82μF ceramic capacitors, C2 and C3 are used for the input filter. An aluminum electrolytic type can be substituted as long as it is rated for at least 1.9A RMS. The basic two-transistor synchronous forward converter diagram is shown in Figure 3. The idealized equations for duty cycle relationships are shown below.

Basic Duty Cycle Equation:

$$V_{OUT} = V_{IN} \cdot DC \cdot \frac{N_S}{N_P}$$

Input Capacitor RMS Current:

$$I_{RMS} = I_{OUT} \cdot \frac{N_S}{N_P} \cdot \sqrt{DC - DC^2}$$

Output Capacitor RMS Current:

$$I_{RMS} = \frac{I_L(pk-pk)}{\sqrt{12}}$$

Inductor Ripple Current:

$$I_L(pk-pk) = \frac{(V_{OUT} + V_D) \cdot (1-DC) \cdot f_{SW}}{L}$$

Primary RMS Current:

$$I_{RMS} = I_{OUT} \cdot \frac{N_S}{N_P} \cdot \sqrt{DC}$$

Secondary RMS Current:

$$I_{RMS} = I_{OUT} \cdot \sqrt{DC}$$

SAFETY AND ISOLATION

The demo board is designed to meet the requirements of UL 60950, 3rd edition for basic insulation in secondary circuits. The input is considered to be a TNV-2 circuit, and the output is SELV. The optocoupler and bridging capacitor both have agency file numbers. A 3A fast blow type fuse must be placed in series with the ungrounded (hot) input line.

The transformer is designed to meet the basic insulation requirement, with an isolation voltage of 1500VDC. The core is considered to be part of the secondary circuit. As currently built, the transformer uses a class A material insulating system.

CONDUCTED EMI

Tests for conducted emissions were performed for the demo board. A small external PI filter using a 12μF aluminum electrolytic capacitor, 15μH inductor and 10μF film capacitor allows the converter to meet the CISPR 22 class B limit. No tests for radiated RFI were performed because the radiation is application specific. Proper grounding and layout technique must be observed to minimize radiation. See Figure 4 for test setup.

QUICK START GUIDE FOR DEMONSTRATION CIRCUIT 479

ISOLATED SYNCHRONOUS FORWARD CONVERTER—QUARTER BRICK

RELIABILITY

Reliability prediction for the circuit has been calculated using the Telcordia (formerly Bellcore) SR-332. The

black box technique was used. The calculation was made assuming a ground, fixed, controlled environment and quality level II. A 50% electrical stress at 40°C yields an MTBF (mean time between failures) of 1.5 million hours.

QUICK START PROCEDURE

Demonstration circuit 479 is easy to set up to evaluate the performance of the LT3781 and LTC1698. Refer to Figure 1 for proper measurement equipment setup and follow the procedure below:

NOTE: When measuring the input or output voltage ripple, care must be taken to avoid a long ground lead on the oscilloscope probe. Measure the input or output voltage ripple by touching the probe tip directly across the Vin or Vout and GND terminals. See Figure 2 for proper scope probe technique.

1. For normal operation, leave the On/Off pin open. Shorting this pin to $-V_{in}$ will turn off the converter.

2. Connect $-Sense$ to $-V_{out}$ and $+Sense$ to $+V_{out}$. The Trim pin should be left floating.
3. Connect the power supply and meters to the V_{in} pins.
4. Connect the load and meters to the V_{out} pins.
5. After all connections are made, turn on the input power and verify the output voltage, regulation, ripple voltage, efficiency and other parameters.

See Figure 5 to Figure 13 for expected performance.

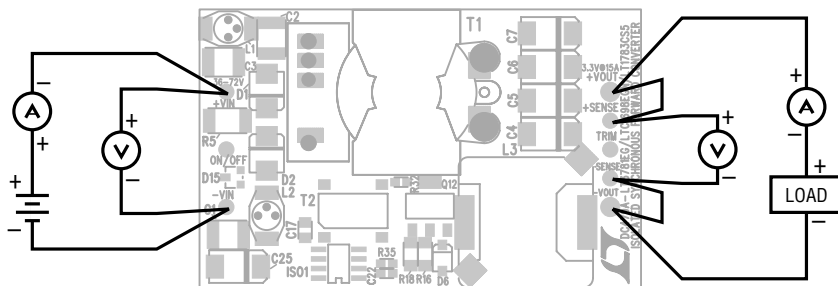

Figure 1. Proper Measurement Equipment Setup

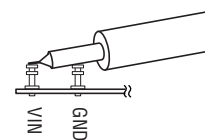

Figure 2. Measuring Input or Output Ripple

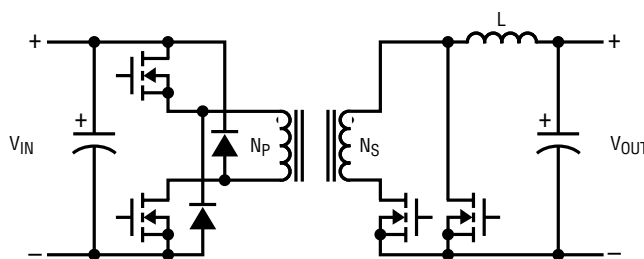

Figure 3. Basic Two-transistor Forward Converter

QUICK START GUIDE FOR DEMONSTRATION CIRCUIT 479

ISOLATED SYNCHRONOUS FORWARD CONVERTER—QUARTER BRICK

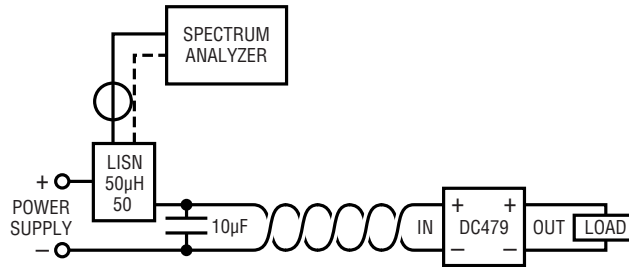

Figure 4. EMI Test Setup

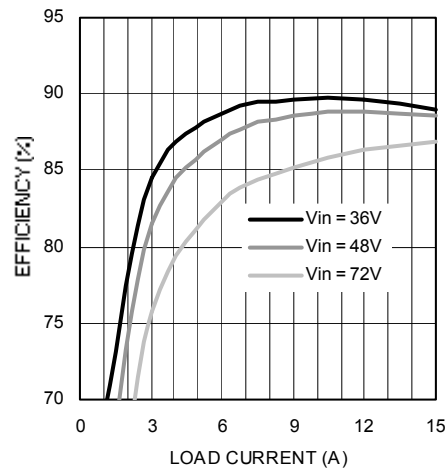

Figure 5. Typical Efficiency

QUICK START GUIDE FOR DEMONSTRATION CIRCUIT 479

ISOLATED SYNCHRONOUS FORWARD CONVERTER—QUARTER BRICK

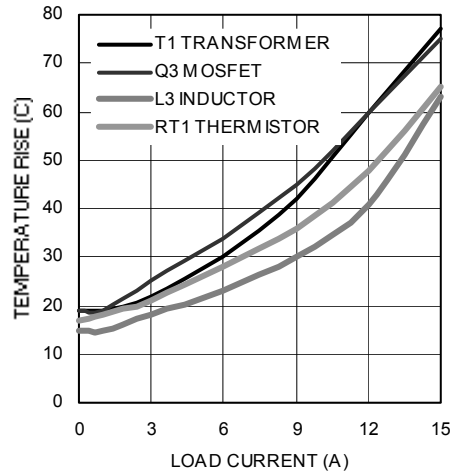

Figure 6. Temperature Rise at $V_{IN} = 36V$, No Airflow

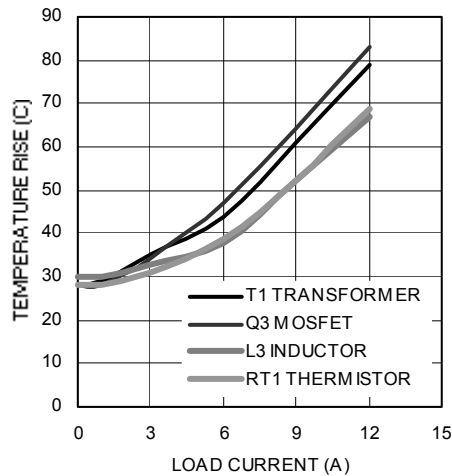

Figure 7. Temperature Rise at $V_{IN} = 72V$, No Airflow

QUICK START GUIDE FOR DEMONSTRATION CIRCUIT 479

ISOLATED SYNCHRONOUS FORWARD CONVERTER—QUARTER BRICK

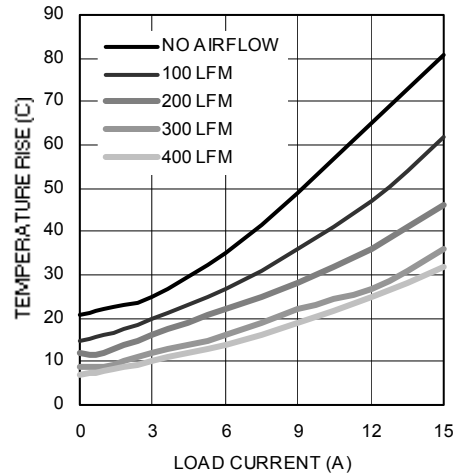

Figure 8. Q3 Temperature Rise at $V_{IN} = 48V$ (Hottest PCB Spot)

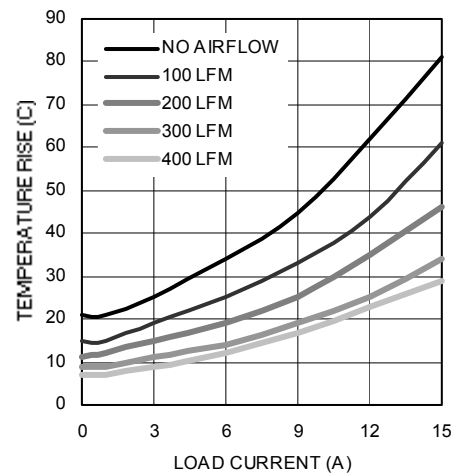

Figure 9. T1 Temperature Rise at $V_{IN} = 48V$

QUICK START GUIDE FOR DEMONSTRATION CIRCUIT 479

ISOLATED SYNCHRONOUS FORWARD CONVERTER—QUARTER BRICK

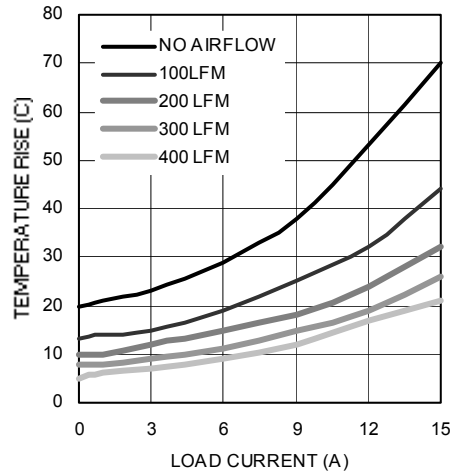

Figure 10. L3 Temperature Rise at $V_{IN} = 48V$

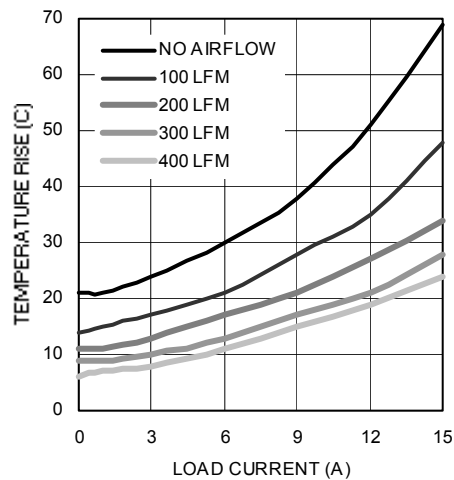

Figure 11. RT1 Temperature Rise at $V_{IN} = 48V$

QUICK START GUIDE FOR DEMONSTRATION CIRCUIT 479

ISOLATED SYNCHRONOUS FORWARD CONVERTER—QUARTER BRICK

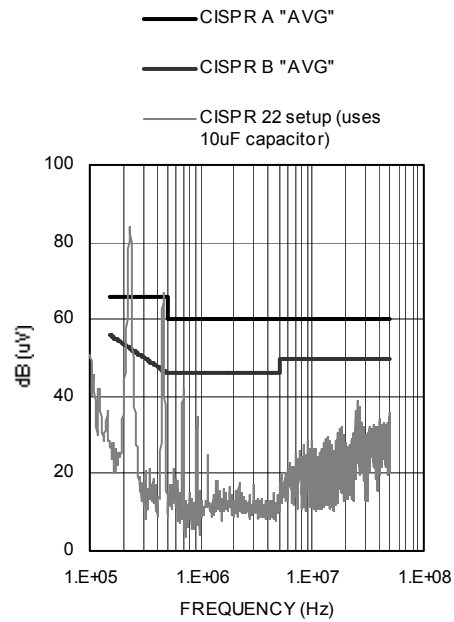

Figure 12. Conducted Emissions at $V_{IN} = 48V$

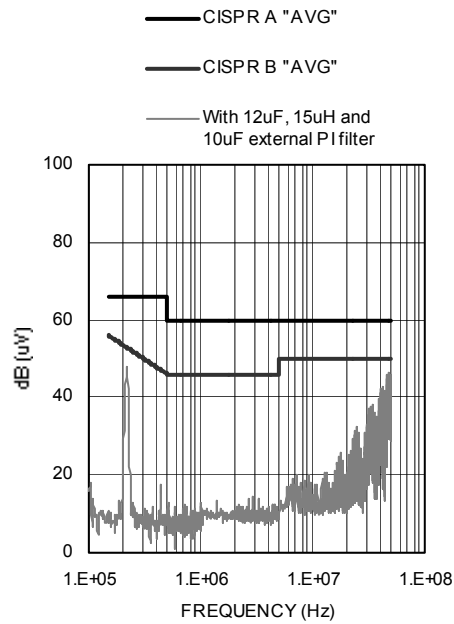
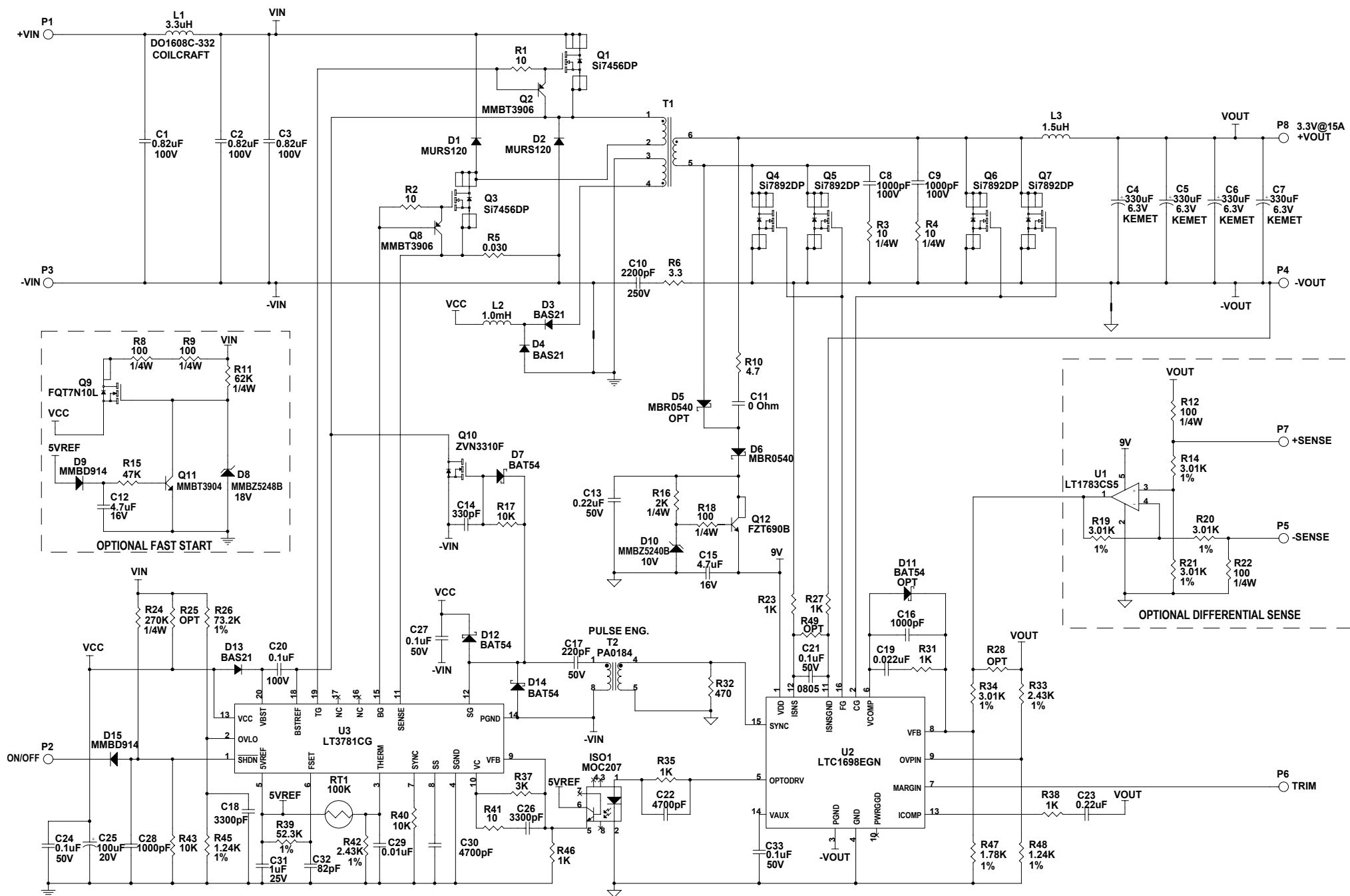

Figure 13. Conducted Emissions at $V_{IN} = 48V$ with External PI Filter



NOTES: UNLESS OTHERWISE SPECIFIED

1. TO DISABLE OPTIONAL FAST START:
REMOVE C12, D8, D9, R8, R9, R11, R15, Q9, Q11; ADD R25 = 20K.
2. TO DISABLE OPTIONAL DIFFERENTIAL SENSE:
REMOVE R12, R14, R19-22, U1; ADD R28 = 0 OHM.
3. ALL RES. ARE IN OHMS.
ALL DIODES ARE MMBD914BLT1.
ALL NPNs ARE MMBT3904LT1.
ALL PNP's ARE MMBT3906LT1.

QUICK START GUIDE FOR DEMONSTRATION CIRCUIT 479 ISOLATED SYNCHRONOUS FORWARD CONVERTER - QUARTER BRICK

Linear Technology Corporation

LT3781EG, LTC1698EGN, LT1783CS5
ISOLATED SYNCHRONOUS FORWARD CONVERTER

BILL OF MATERIALS
DC479A-1
QTY-375
10/25/02
4:23 PM

Item	Qty	Reference	Part Description	Manufacture / Part #	Kit Qty
				NUMBER OF BOARDS =	375
1	3	C1,C2,C3	CAP., X7R, 0.82uF, 100V, 20%, 1812	VITRAMON, VJ1812Y824MXB	1125
2	4	C4,C5,C6,C7	CAP., TANT., 330uF, 6.3V, 20%, 7343	KEMET, T520D337M006AS	1500
3	2	C8,C9	CAP., X7R, 1000pF, 100V, 20%, 1206	AVX, 12061C102MAT2A	750
4	1	C10	CAP., X7R, 2200pF, 250VAC, 10%, 2220	MURATA, GHM3045X7R222K-GC	375
5	1	C11	CAP., JMP, 0, 1/4W, 1206	AAC, CJ18-000JM	375
6	2	C12,C15	CAP., X7R, 4.7uF, 16V, 20%, 1210	TAIYO YUDEN, EMK325BJ475MN	750
7	1	C13	CAP., X7R, 0.22uF, 50V, 20%, 1206	AVX, 12065C224MAT2A	375
8	1	C14	CAP., X7R, 330pF, 50V, 10%, 0603	AVX, 06035C331KAT2A	375
9	2	C16,C28	CAP., NPO, 1000pF, 25V, 10%, 0603	AVX, 06033A102KAT2A	750
10	1	C17	CAP., NPO, 220pF, 50V, 10%, 0603	AVX, 06035A221KAT2A	375
11	2	C18,C26	CAP., X7R, 3300pF, 50V, 10%, 0603	AVX, 06035C332KAT2A	750
12	1	C19	CAP., X7R, 0.022uF, 25V, 10%, 0603	AVX, 06033C223KAT2A	375
13	1	C20	CAP., X7R, 0.1uF, 100V, 10%, 1206	AVX, 12061C104KAT2A	375
14	4	C21,C24,C27,C33	CAP., X7R, 0.1uF, 50V, 10%, 0805	AVX, 08055C104KAT2A	1500
15	2	C22,C30	CAP., X7R, 4700pF, 50V, 20%, 0603	AVX, 06035C472MAT2A	750
16	1	C23	CAP., X7R, 0.22uF, 16V, 10%, 0805	AVX, 0805YC224KAT2A	375
17	1	C25	CAP., TANT., 100uF 20V, 20%, 7343	AVX, TAJE107M020R0150	375
18	1	C29	CAP., X7R, 0.01uF, 25V, 10%, 0603	AVX, 06033C103KAT2A	375
19	1	C31	CAP., X7R, 1uF, 25V, 10%, 1206	TAIYO YUDEN, TMK316BJ105KL	375
20	1	C32	CAP., NPO, 82pF, 25V, 10%, 0603	AVX, 06033A820KAT2A	375
21	2	D1,D2	RECTIFIER, 200V, 1Amp, SMB-DIODE	DIODES INC., MURS120	750
22	3	D3,D4,D13	DIODE, Speed Switching, BAS21, SOT23	DIODES INC., BAS21	1125
23	0	D5	DIODE, Schottky, MBR0540, SOD123 OPT	DIODES INC., B0540W	0
24	1	D6	DIODE, Schottky, MBR0540, SOD123	DIODES INC., B0540W	375
25	3	D7,D12,D14	DIODE, Schottky, BAT54,SOT23	DIODES INC., BAT54-7	1125
26	1	D8	DIODE, Zener, 18V, MMBZ5248B,SOT23	DIODES INC., MMBZ5248B-7	375
27	2	D9,D15	DIODE, Switching, MMBD914,SOT23	DIODES INC., MMBD914-7	750
28	1	D10	DIODE, Zener, 10V, MMBZ5240B,SOT23	DIODES INC., MMBZ5240B-7	375
29	0	D11	DIODE, Schottky, BAT54,SOT23 OPT	DIODES INC., BAT54-7	0
30	1	ISO1	I.C., Optocoupler, SO8	FAIRCHILD SEMI., MOC207	375
31	1	L1	IND, 3.3uH, L-DO1608C-S	COILCRAFT, DO1608C-332	375
32	1	L2	IND, 1.0mH, L-DO1608C-S	COILCRAFT, DO1608C-105	375
33	1	L3	IND, 1.5uH, RM7.	SCHOTT, 39603	375
0			IND, CHOKE COIL, 1.3uH, L-PANA-PCCS1	PANASONIC, ETQPAF1R3EFA	0

Linear Technology Corporation

LT3781EG, LTC1698EGN, LT1783CS5
ISOLATED SYNCHRONOUS FORWARD CONVERTER

BILL OF MATERIALS
DC479A-1
QTY-375
10/25/02
4:23 PM

QUICK START GUIDE FOR DEMONSTRATION CIRCUIT 479 ISOLATED SYNCHRONOUS FORWARD CONVERTER - QUARTER BRICK

Item	Qty	Reference	Part Description	Manufacture / Part #	Kit Qty
				NUMBER OF BOARDS =	375
34	6	P1,P2,P3,P5,P6,P7	CONN, Swage Mount, PIN40	KEYSTONE, 1425-2	2250
35	2	P4,P8	CONN, 0.060PIN, 0.320 LONG, PIN62	STAFFAL INC., NIP-0913-01-CET-00	750
36		FOR P1-P8	Special Tools (1 set each)	KEYSTONE TL-2, & USECO TL-7721	
37	2	Q1,Q3	TRANSISTOR, N-Mosfet, 100V, SO8-POWERPAK	VISHAY SILICONIX, Si7456DP	750
38	2	Q2,Q8	TRANSISTOR, PNP, MMBT3906LT1, SOT23	DIODES INC., MMBT3906	750
39	4	Q4,Q5,Q6,Q7	TRANSISTOR, N-Mosfet, 30V, SO8-POWERPAK	VISHAY SILICONIX, Si7446DP	1500
40	1	Q9	TRANSISTOR, N-Channel, SOT223	FAIRCHILD SEMI., FQT7N10LTF	375
41	1	Q10	TRANSISTOR, N-DMosfet, SOT23	ZETEX, ZVN3310F	375
42	1	Q11	TRANSISTOR, NPN, MMBT3904, SOT23	DIODES INC., MMBT3904	375
43	1	Q12	TRANSISTOR, High Gain, NPN, SOT223	ZETEX, FZT690B	375
44	1	RT1	THERMISTOR, 100K, 5%, 1206	VISHAY DALE, NTHS1206N01N1003J	375
45	3	R1,R2,R41	RES., Chip, 10, 1/16W, 5%, 0603	AAC, CR16-100JM	1125
46	2	R3,R4	RES., Chip, 10, 1/4W, 5%, 1206	AAC, CR18-100JM	750
47	1	R5	RES., 0.030, 1/2W, 1%, 2010	DALE, WSL2010 0.030 1.0%R86	375
48	1	R6	RES., Chip, 3.3, 1/4W, 5%, 1206	AAC, CR18-3R3JM	375
49	5	R8,R9,R12,R18,R22	RES., Chip, 100, 1/4W, 5%, 1206	AAC, CR18-101JM	1875
50	1	R10	RES., Chip, 4.7, 1/4W, 5%, 1206	AAC, CR18-4R7JM	375
51	1	R11	RES., Chip, 62K, 1/4W, 5%, 1206	AAC, CR18-623JM	375
52	0	R25	RES., Chip, 20K, 1/4W, 5%, 1206	AAC, CR18-203JM	0
53	5	R14,R19,R20,R21,R34	RES., Chip, 3.01K, 1/16W, 1%, 0603	AAC, CR16-3011FM	1875
54	1	R15	RES., Chip, 47K, 1/16W, 5%, 0603	AAC, CR16-473JM	375
55	1	R16	RES., Chip, 2K, 1/4W, 5%, 1206	AAC, CR18-202JM	375
56	3	R17,R40,R43	RES., Chip, 10K, 1/16W, 5%, 0603	AAC, CR16-103JM	1125
57	7	R23,R27,R31,R35,R38,R46,R49	RES., Chip, 1K, 1/16W, 5%, 0603	AAC, CR16-102JM	2625
58	1	R24	RES., Chip, 270K, 1/4W, 5%, 1206	AAC, CR18-274JM	375
59	1	R26	RES., Chip, 73.2K, 1/16W, 1%, 0603	AAC, CR16-7322FM	375
60	0	R28	RES., Chip, 0603	TBD	0
61	1	R32	RES., Chip, 470, 1/4W, 5%, 0603	AAC, CR16-471JM	375
62	2	R33,R42	RES., Chip, 2.43K, 1/16W, 1%, 0603	AAC, CR16-2431FM	750
63	1	R37	RES., Chip, 3K, 1/16W, 5%, 0603	AAC, CR16-302JM	375
64	1	R39	RES., Chip, 52.3K, 1/16W, 1%, 0603	AAC, CR16-5232FM	375
65	2	R45,R48	RES., Chip, 1.24K, 1/16W, 1%, 0603	AAC, CR16-1241FM	750
66	1	R47	RES., Chip, 1.78K, 1/16W, 1%, 0603	AAC, CR16-1781FM	375
67	1	T1	TRANSFORMER, 39402	SCHOTT, 39402	375

QUICK START GUIDE FOR DEMONSTRATION CIRCUIT 479 ISOLATED SYNCHRONOUS FORWARD CONVERTER – QUARTER BRICK

Linear Technology Corporation
 LT3781EG, LTC1698EGN, LT1783CS5
 ISOLATED SYNCHRONOUS FORWARD CONVERTER

BILL OF MATERIALS
DC479A-1
QTY-375
 10/25/02
 4:23 PM

Item	Qty	Reference	Part Description	Manufacture / Part #	Kit Qty
				NUMBER OF BOARDS =	375
	0				0
68	1	T2	TRANSFORMER, PA0191	PULSE ENG., PA0191	375
69	1	U1	TRANSFORMER, 1.4mH min. 50kHz, PA0184	PULSE ENG., PA0184	375
70	1	U2	I.C., Op Amp. LT1783CS5, SOT23-5	LINEAR TECH., LT1783CS5	375
71	1	U3	I.C., LTC1698EGN, SSOP16GN	LINEAR TECH., LTC1698EGN	375
			I.C., LT3781EG, SSOP20G	LINEAR TECH., LT3781EG	375
			NOTES: UNLESS OTHERWISE SPECIFIED		
			1. ALL RESISTORS ARE IN OHMS.		
			2. P1-P8 ARE STUFFED ON THE BOTTOM SIDE.		

QUICK START GUIDE FOR DEMONSTRATION CIRCUIT 479

ISOLATED SYNCHRONOUS FORWARD CONVERTER – QUARTER BRICK

APPROVED VENDOR LIST

VENDOR	PHONE NUMBER	PART TYPE	WEBSITE ADDRESS
AAC (was TAD)	(800) 508-1521	CHIP RESISTORS	
AAC (was TAD)	(714) 255-9186		
AAVID	(714) 556-2665	HEAT SINKS	
ALLEN BRADLEY	(800) 592-4888	CARBON RESISTORS	
AMP	(717) 564-0100	PC MOUNT BNC	
APEM	(718) 246-1007	SMD TOGGLE/PB SWITCH	
API DELEVAN	(716) 652-3600	INDUCTORS	
AVX	(843) 946-0362	CHIP CAPS	
AVX	(843) 946-0524	CHIP RESISTORS	
AVX	(207) 282-5111	TANTALUM CAPS	
AVX	(843) 946-0323	HIGH VOLTAGE CAPS	
BERG	(800) 237-2374	CONNECTORS	
BH ELECTRONICS	(952) 894-9590	INDUCTORS	
BI TECHNOLOGIES	(714) 447-2656	TRANSFORMERS	
BI TECHNOLOGIES	(714) 447-2345	RES./RES. NETWORKS	
BOURNS	(801) 750-7253	POTENTIOMETERS, SIPS	
CADDOCK ELECTRONICS	(541) 496-0700	HIPO. RES., SIPS, DIPS	
CENTRAL SEMI	(631) 435-1110	SMALL SIGNAL DISCRETES	
CHICAGO MINIAT. LAMP	(201) 489-8989	LEDS	
COILCRAFT	(847) 639-6400	INDUCTORS	
COMM CON	(626) 301-4200	HEADERS, SHUNTS	
CONNEX	(805) 378-6464	BNC CONNECTORS	
COOPER ELECT. TECH.	(561) 752-5000	INDUCTORS	
CORNELL DUBILIER	(508) 996-8561	CAPACITORS	
CTS	(219) 293-7511	RESISTOR ARRAYS	
CUI-STACK	(503) 643-4899	POWER CONNECTORS	
DALE (see Vishay)	(605) 665-1627	INDUCTORS	
DALE (see Vishay)	(605) 665-9301	SENSE RESISTORS	
DATA DISPLAY PRODUCT	(800) 421-6815	LEDS	
DIODES INC.	(805) 446-4800	DIODES	
ELECTRONIC CONCEPTS	(908) 542-7880	400V FILM CAPACITORS	
EPSON	(310) 787-6300	CRYSTALS	
FAIRCHILD	(207) 775-4502	LOGIC	
FAIRCHILD	(408) 822-2126	MOSFETS	
FAIRCHILD	(888) 522-5372	CRG (CUST. RESPONSE)	
FCI	(717) 767-8005	HOT PLUG CONNECTORS	
FUKUSHIMA	(818) 765-8300	MPC RESISTORS	
FUJI	(201) 712-0555	SCHOTTKY DIODES	
GENERAL SEMICONDUCTOR	(516) 847-3000	DIODES	
GOWANDA	(716) 532-2234	INDUCTORS	
GRAYHILL	(708) 354-1040	DIP SWITCHES	
HARRIS	(800) 442-7747	LOGIC	
HEWLETT PACKARD	(800) 235-0312	IR LED	
HITACHI	(408) 433-1990	RF POWER AMPS	

QUICK START GUIDE FOR DEMONSTRATION CIRCUIT 479

ISOLATED SYNCHRONOUS FORWARD CONVERTER – QUARTER BRICK

IDT	(408) 727-6116	LOGIC IC
IR	(310) 322-3331	MOSFETS
IRC	(361) 992-7900	SENSE RESISTORS
ITW PAKTRON	(708) 667-3444	CAPACITORS
JOHNSON COMPONENTS	(650) 948-6533	RF CONNECTORS
JOHNSON COMPONENTS	(760) 434-5961	RF CONNECTORS
KEMET	(408) 986-0424	TANTALUM CAPS
KEMET	(864) 963-6300	CRG (CUST. RESPONSE)
KETEMA	(714) 630-0081	SURGE SUPPRESSORS
KEYSTONE	(718) 956-8900	JACKS, TURRETS
LITEON	(408) 241-4588	LEDS, DIODES
LTC	(408) 432-1900	HIGH PERF. I.C.S
MAGNETICS	(800) 245-3984	TOROID CORES ETC.
MARCON	(847) 696-2000	HIGH C/V CAPACITORS
METHODE	(800) 323-6864	ZIF SOCKETS
MF ELECTRONICS	(914) 576-6570	CRYSTAL OSCILLATORS
MICROCHIP	(602) 786-7200	MICROCONTROLLER IC
MICRO PLASTICS	(870) 453-8861	NYLON STANDOFFS
MICRO-SEMI	(617) 926-0404	DIODES
MIDCOM	(605) 886-4385	INDUCTORS
MIDCOM	(800) 643-2661	INDUCTORS
MILL-MAX	(516) 922-6000	TURRETS
MINICIRCUITS	(718) 934-4500	RF TRANSFORMERS
MOTOROLA	(800) 441-2447	LOGIC, REGS
MURATA ELECTRONICS	(770) 436-1300	CAPS., INDUCTORS,
MURATA ELECTRONICS	(800) 831-9172	CRG (CUST. RESPONSE)
MURATA ELECTRONICS	(770) 433-5789	RF DEVICES
NEC/TOKIN	(510) 324-4110	INDUCTORS/HI C/V CAPS
NICHIA	(408) 573-0933	WHITE LEDS
NICHICON	(847) 843-7500	ELECTROLYTIC CAPACITOR
ON SEMICONDUCTOR	(602) 244-6600	DISCRETE DIODES ETC.
ON SHORE	(602) 921-3000	TERMINATORS
PANASONIC	(714) 373-7334	INDUCTORS, POLY CAPS
PANASONIC	(201) 348-5217	LEDS
PANASONIC	(201) 373-7334	SWITCHES
PERICOM	(408) 435-0800	LOGIC IC
PHILIPS	(914) 246-2811	INDUCTORS
PHILIPS	(914) 247-2036	PLANAR INDUCTORS
PHILIPS	(508) 851-2200	DISCRETES, I.C.s
PULSE	(619) 674-8100	INDUCTORS
QT OPTOELECTRONICS	(408) 720-1440	RF SWITCH
RAYCHEM	(800) 227-4856	FUSES
RG ALLEN	(818) 765-8300	METAL OXIDE RESISTORS
RF MICRO DEVICES	(336) 664-1233	RF2138 / RF2140
SAMTEC	(800) 726-8329	WIRE JUMPERS
SANYO	(619) 661-6835	OSCON CAPS
SCHOTT	(507) 532-3201	INDUCTORS, XFORMERS

QUICK START GUIDE FOR DEMONSTRATION CIRCUIT 479

ISOLATED SYNCHRONOUS FORWARD CONVERTER – QUARTER BRICK

SCHURTER	(707) 778-6311	FUSES AND HOLDERS
SIGNATRON	(909) 464-1883	DB9 CONNECTORS
SIEMENS	(108) 257-7910	OPTO
SILICONIX	(800) 554-5565	MOSFETS
SILICONIX	(408) 988-8000	MOSFETS
SPRAGUE	(207) 324-4140	CAPACITORS
SULLINS	(760) 744-0125	HEADERS, SHUNTS
SUMIDA	(847) 956-0667	INDUCTORS
SUMIDA	(408) 982-9660	INDUCTORS
TAIYO YUDEN	(408) 573-4150	CHIP CAPS / RES.
TAIYO YUDEN	(800) 348-2496	CRG (CUST. RESPONSE)
TEKTRONIX	(800) 835-9433	SCOPE PROBE SOCKETS
TEMIC	(408) 970-5700	IR PHOTO DIODE
THERMALLOY	(972) 243-4321	HEAT SINKS
THIN FILM TECHNOLOGY	(507) 625-8445	THIN FILM CHIP RESISTORS
TOCOS	(847) 884-6664	SMD POTENTIOMETERS
TOKIN (NEC)	(510) 324-4110	CAPS., INDUCTORS,
TOKO	(847) 699-3430	RF PRODUCTS
TOSHIBA	(714) 455-2000	SINGLE GATE LOGIC
TOSHIBA	(949) 455-2000	LOGIC
UNITED CHEMICON	(847) 696-2000	ELECTROLYTIC CAPACITOR
VISHAY	(605) 665-9301	ZENER/SM. SIGNAL DIODES
VISHAY	(605) 665-9301	INDUCTORS, SENSE Rs
VITRAMON	(203) 268-6261	CERAMIC CHIP CAPACITOR
WIMA	(914) 347-2474	PAPER/FILM CAPACITORS
ZETEX	(631) 366-5068	SMALL SIGNAL DISCRETES
ZIERICK	(800) 882-8020	STAKED PINS

QUICK START GUIDE FOR DEMONSTRATION CIRCUIT 479 ISOLATED SYNCHRONOUS FORWARD CONVERTER - QUARTER BRICK

REVISIONS			
REV	DESCRIPTION	APPR	DATE
A	PROTOTYPE RELEASE		

SIZE	QTY	SYM	PLTD
0.01	226	+	PLTD
0.043	6	X	PLTD
0.065	2	□	PLTD

NOTES: UNLESS OTHERWISE SPECIFIED

- MATERIAL : FR4 OR EQUIVALENT EPOXY, 2 OZ. COPPER CLAD THICKNESS .062 +/- .006 TOTAL OF 8 LAYERS. TOLERANCES ON COPPER THICKNESS FOR 2 OZ: 1 OZ (MATERIAL) + 10Z (PLATE UP) +/- .25*
- FINISH : ALL PLATED HOLES 30Z COPPER PLATE ELECTRODEPOSITED TIN-LEAD COMPOSITION BEFORE REFLOW, SOLDER MASK OVER BARE COPPER (SMOBC).
- SOLDER MASK : BOTH SIDES USING LPI OR EQUIVALENT.
- SILKSCREEN : USING WHITE NON-CONDUCTIVE EPOXY INK.
- UNUSED SMD COMPONENTS SHOULD BE FREE OF SOLDER.
- FABRICATE EACH PANEL BY "TAB ROUTE AND RETAIN" WITH "RAT-BITES" ON THE TABS.
- ALL 10 MIL VIAS SHOULD BE DRILLED BY 13 MIL DRILL SIZE, THEN PLATE UP TO 3 OZ COPPER. VIAS CAN BE PLATED SHUT.
- PLEASE LOOK AT THE READ ME FILE FOR THE OTHER REQUIREMENTS.

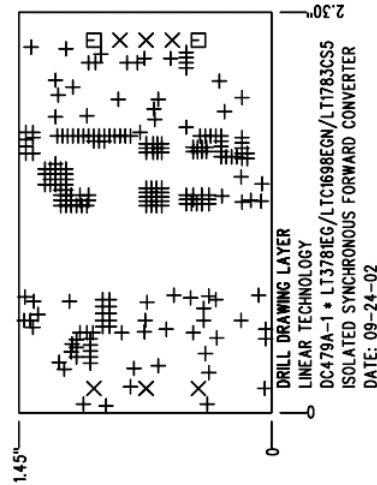

SHOWN FROM COMPONENT SIDE

APPROVALS		INIT		DATE	
DRAWN					
CHECK					
DESIGN	KIM T.			09-24-02	
ENGR	BOB S.			09-24-02	
TITLE: FABRICATION DRAWING					
ISOLATED SYNCHRONOUS FORWARD CONVERTER					
SIZE	A	DEMO	DC479A-1	REV.	A
SCALE = NONE				DES- 0000	
				SHT 1 of 1	



1630 McCarthy Blvd.
Milpitas, CA 95035
PH: (408)432-1900

QUICK START GUIDE FOR DEMONSTRATION CIRCUIT 479 ISOLATED SYNCHRONOUS FORWARD CONVERTER – QUARTER BRICK

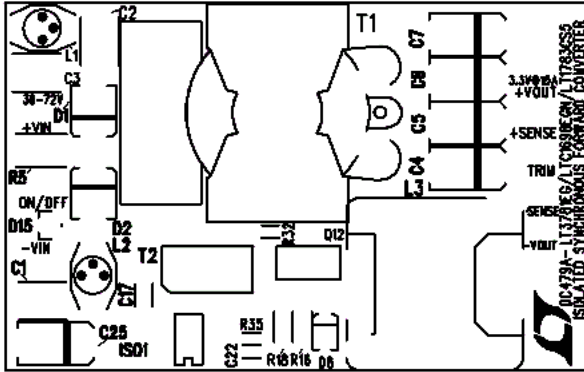

TOP SILKSCREEN
LINEAR TECHNOLOGY
DC479A-1 * LT3781EG/LTC1698EGN/LT1783CS5
ISOLATED SYNCHRONOUS FORWARD CONVERTER

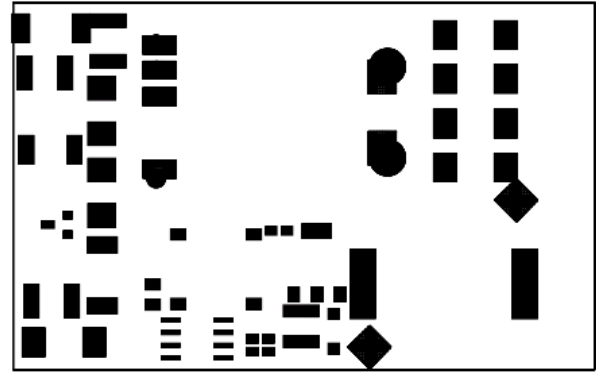

TOP SOLDER PASTE
LINEAR TECHNOLOGY
DC479A-1 * LT3781EG/LTC1698EGN/LT1783CS5
ISOLATED SYNCHRONOUS FORWARD CONVERTER

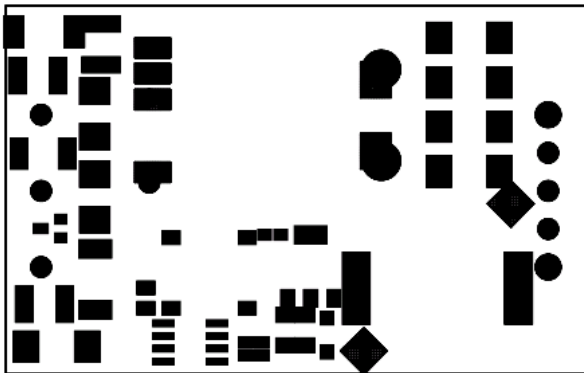

TOP SOLDER MASK
LINEAR TECHNOLOGY
DC479A-1 * LT3781EG/LTC1698EGN/LT1783CS5
ISOLATED SYNCHRONOUS FORWARD CONVERTER

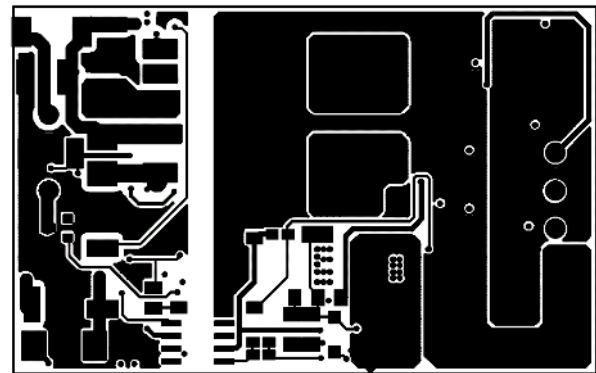

LAYER 1 - TOP LAYER
LINEAR TECHNOLOGY
DC479A-1 * LT3781EG/LTC1698EGN/LT1783CS5
ISOLATED SYNCHRONOUS FORWARD CONVERTER

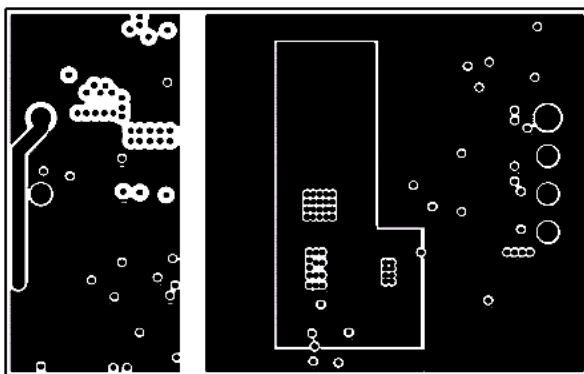

LAYER 2: -VIN/-VOUT
LINEAR TECHNOLOGY
DC479A-1 * LT3781EG/LTC1698EGN/LT1783CS5
ISOLATED SYNCHRONOUS FORWARD CONVERTER

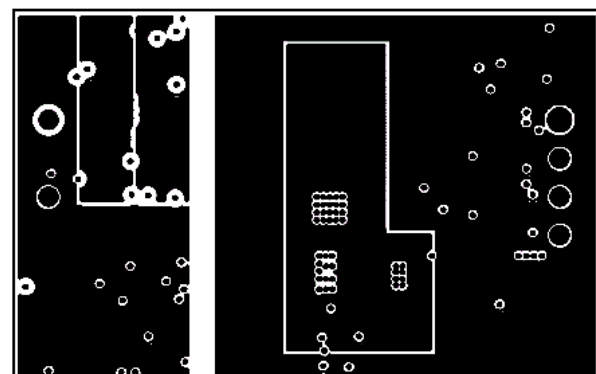

LAYER 3: -VIN/-VOUT
LINEAR TECHNOLOGY
DC479A-1 * LT3781EG/LTC1698EGN/LT1783CS5
ISOLATED SYNCHRONOUS FORWARD CONVERTER

QUICK START GUIDE FOR DEMONSTRATION CIRCUIT 479

ISOLATED SYNCHRONOUS FORWARD CONVERTER – QUARTER BRICK

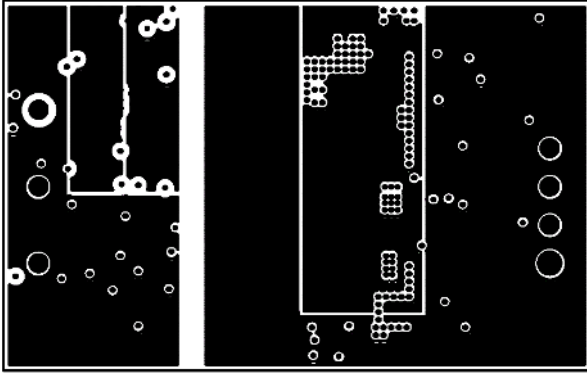

LAYER 4: GNDPRI/VOUT
LINEAR TECHNOLOGY
DC479A-1 * LT3781EG/LTC1698EGN/LT1783CS5
ISOLATED SYNCHRONOUS FORWARD CONVERTER

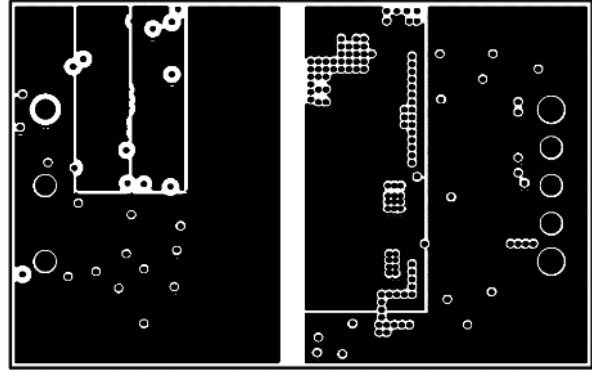

LAYER 5: GNDPRI/GNDSEC
LINEAR TECHNOLOGY
DC479A-1 * LT3781EG/LTC1698EGN/LT1783CS5
ISOLATED SYNCHRONOUS FORWARD CONVERTER

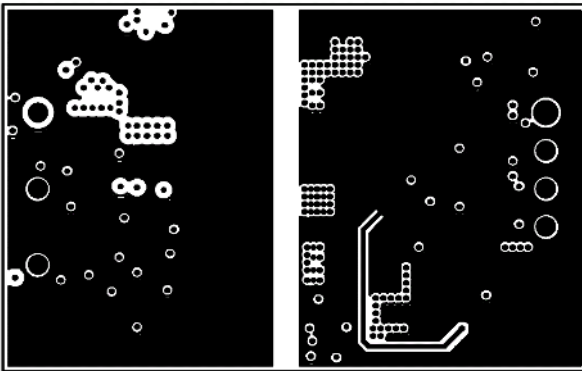

LAYER 6: GNDPRI/-VOUT
LINEAR TECHNOLOGY
DC479A-1 * LT3781EG/LTC1698EGN/LT1783CS5
ISOLATED SYNCHRONOUS FORWARD CONVERTER

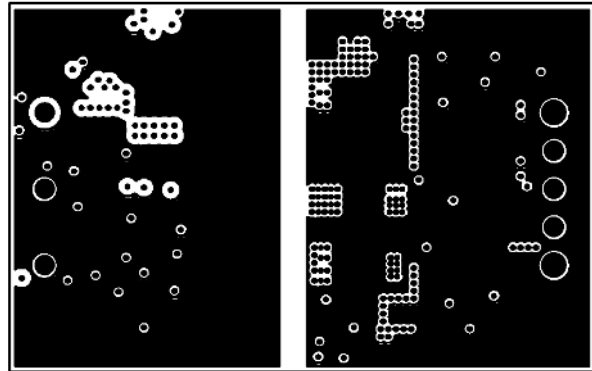

LAYER 7: GNDPRI/GNDSEC
LINEAR TECHNOLOGY
DC479A-1 * LT3781EG/LTC1698EGN/LT1783CS5
ISOLATED SYNCHRONOUS FORWARD CONVERTER

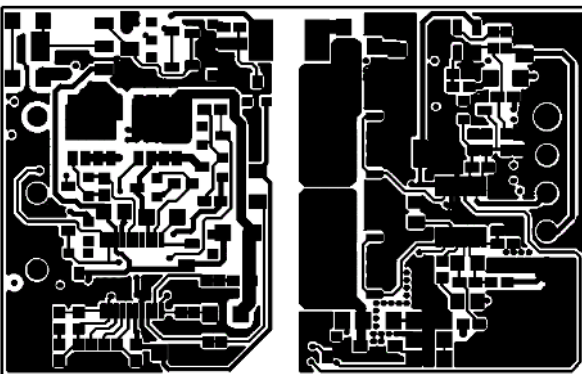

LAYER 8 - BOTTOM LAYER
LINEAR TECHNOLOGY
DC479A-1 * LT3781EG/LTC1698EGN/LT1783CS5
ISOLATED SYNCHRONOUS FORWARD CONVERTER

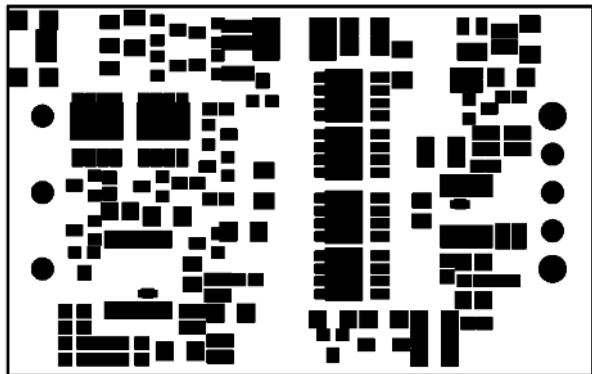

BOTTOM SOLDER MASK
LINEAR TECHNOLOGY
DC479A-1 * LT3781EG/LTC1698EGN/LT1783CS5
ISOLATED SYNCHRONOUS FORWARD CONVERTER

QUICK START GUIDE FOR DEMONSTRATION CIRCUIT 479 ISOLATED SYNCHRONOUS FORWARD CONVERTER - QUARTER BRICK

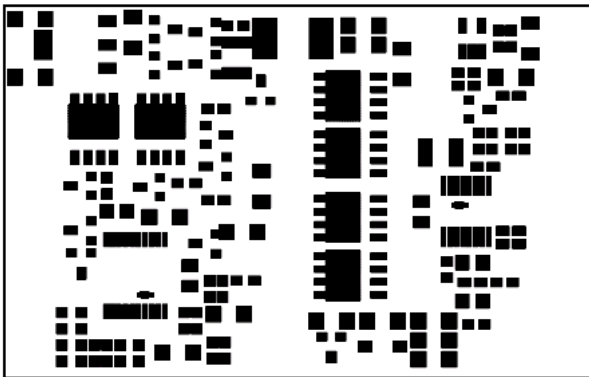

BOTTOM SOLDER PASTE
LINEAR TECHNOLOGY
DC479A-1 * LT3781EG/LTC1698EGN/LT1783CS5
ISOLATED SYNCHRONOUS FORWARD CONVERTER

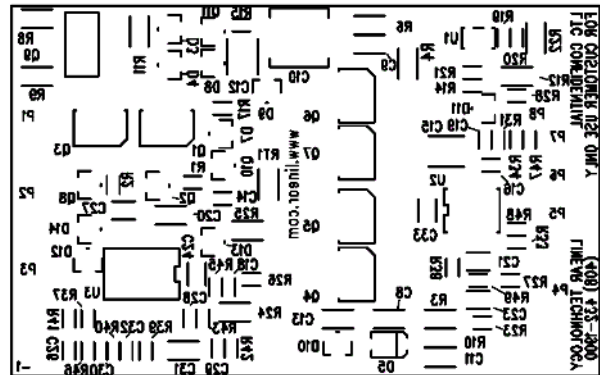

BOTTOM SILKSCREEN
LINEAR TECHNOLOGY
DC479A-1 * LT3781EG/LTC1698EGN/LT1783CS5
ISOLATED SYNCHRONOUS FORWARD CONVERTER