

1.8-V, 7-MHz, 90-dB CMRR, SINGLE-SUPPLY, RAIL-TO-RAIL I/O OPERATIONAL AMPLIFIER

FEATURES

- Qualified for Automotive Applications
- 1.8-V Operation
- Bandwidth: 7 MHz
- CMRR: 90 dB (Typ)
- Slew Rate: 5 V/μs
- Low Offset: 500 μV (Max)
- Quiescent Current: 750 μA/Channel (Max)
- Shutdown Mode: <1 μA/Channel

APPLICATIONS

- Signal Conditioning
- Data Acquisition
- Process Control
- Active Filters
- Test Equipment

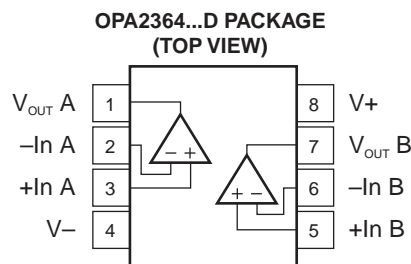
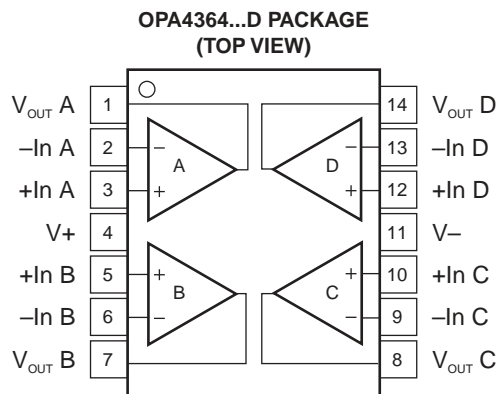

DESCRIPTION

The OPA2364 and OPA4364 are high-performance CMOS operational amplifiers optimized for low-voltage single-supply operation. These miniature low-cost amplifiers are designed to operate on single supplies from 1.8 V (± 0.9 V) to 5.5 V (± 2.75 V). Applications include sensor amplification and signal conditioning in battery-powered systems.

The OPAx364 family offers excellent CMRR without the crossover associated with traditional complimentary input stages. This results in excellent performance for driving analog-to-digital (A/D) converters without degradation of differential linearity and total harmonic distortion (THD). The input common-mode range includes both the negative and positive supplies. The output voltage swing is within 10 mV of the rails.

The dual version is available in an SO-8 package and the quad package is available in an SO-14 package. All versions are specified for operation from -40°C to 125°C .



Please be aware that an important notice concerning availability, standard warranty, and use in critical applications of Texas Instruments semiconductor products and disclaimers thereto appears at the end of this data sheet.



This integrated circuit can be damaged by ESD. Texas Instruments recommends that all integrated circuits be handled with appropriate precautions. Failure to observe proper handling and installation procedures can cause damage.

ESD damage can range from subtle performance degradation to complete device failure. Precision integrated circuits may be more susceptible to damage because very small parametric changes could cause the device not to meet its published specifications.

ORDERING INFORMATION

| PRODUCT | PACKAGE LEAD | PACKAGE DESIGNATOR | T _A | PACKAGE MARKING | ORDERING NUMBER | TRANSPORT MEDIA, QUANTITY |
|---------------|--------------|--------------------|----------------|-----------------|-----------------|---------------------------|
| OPA2364AQDRQ1 | SO-8 | D | –40°C to 125°C | OP2364 | OPA2364AQDRQ1 | Tape and reel, 2500 |
| OPA4364AQDRQ1 | SO-14 | D | –40°C to 125°C | OPA4364AQ | OPA4364AQDRQ1 | Tape and reel, 2500 |

ABSOLUTE MAXIMUM RATINGS⁽¹⁾

over operating free-air temperature range (unless otherwise noted)

| | | MIN | MAX | UNIT |
|--|------------------------------|-----------|------------|------|
| Supply voltage | | | 5.5 | V |
| Signal input terminals | Voltage range ⁽²⁾ | –0.5 | (V+) + 0.5 | V |
| | Current ⁽²⁾ | | ±10 | mA |
| Enable input range | | (V–) –0.5 | 5.5 | V |
| Output short circuit ⁽³⁾ | | | Continuous | |
| Operating temperature range | | –40 | 150 | °C |
| T _{stg} Storage temperature range | | –65 | 150 | °C |
| T _J Junction temperature | | | 150 | °C |
| Lead temperature (soldering, 10 s) | | | 300 | °C |

- (1) Stresses above these ratings may cause permanent damage. Exposure to absolute maximum conditions for extended periods may degrade device reliability. These are stress ratings only, and functional operation of the device at these or any other conditions beyond those specified is not implied.
- (2) Input terminals are diode clamped to the power-supply rails. Input signals that can swing more than 0.5 V beyond the supply rails should be current limited to 10 mA or less.
- (3) Short circuit to ground one amplifier per package

ELECTRICAL CHARACTERISTICS: $V_S = 1.8\text{ V to }5.5\text{ V}$

Boldface limits apply over the specified temperature range, $T_A = -40^\circ\text{C to }125^\circ\text{C}$, $T_A = 25^\circ\text{C}$, $R_L = 10\text{ k}\Omega$ connected to $V_S/2$, and $V_{OUT} = V_S/2$, $V_{CM} = V_S/2$ (unless otherwise noted)

| PARAMETER | | TEST CONDITIONS | MIN | TYP | MAX | UNIT |
|----------------------------|-------------------------------------|---|--|------------|---------------|------------------------------|
| Offset Voltage | | | | | | |
| V_{OS} | Input offset voltage | $V_S = 5\text{ V}$ | | 1 | 3 | mV |
| dV_{OS}/dT | Drift | | | 3 | | $\mu\text{V}/^\circ\text{C}$ |
| PSRR | Power-supply rejection ratio | $V_S = 1.8\text{ V to }5.5\text{ V}$, $V_{CM} = 0$ | | 80 | 330 | $\mu\text{V}/\text{V}$ |
| | Channel separation, dc | | | 1 | | $\mu\text{V}/\text{V}$ |
| Input Bias Current | | | | | | |
| I_B | Input bias current | | | ± 1 | ± 10 | μA |
| | | Over temperature | See Typical Characteristics | | | |
| I_{OS} | Input offset current | | | ± 1 | ± 10 | μA |
| Noise | | | | | | |
| e_n | Input voltage noise | $f = 0.1\text{ Hz to }10\text{ Hz}$ | | 10 | | μV_{P-P} |
| | Input voltage noise density | $f = 10\text{ kHz}$ | | 17 | | $\text{nV}/\sqrt{\text{Hz}}$ |
| i_n | Input current noise density | $f = 10\text{ kHz}$ | | 0.6 | | $\text{fA}/\sqrt{\text{Hz}}$ |
| Input Voltage Range | | | | | | |
| V_{CM} | Common-mode voltage range | | $(V_-) - 0.1$ | | $(V_+) + 0.1$ | V |
| CMRR | Common-mode rejection ratio | $(V_-) - 0.1\text{ V} < V_{CM} < (V_+) + 0.1\text{ V}$ | 74 | 90 | | dB |
| Input Capacitance | | | | | | |
| | Differential | | | 2 | | pF |
| | Common mode | | | 3 | | pF |
| Open-Loop Gain | | | | | | |
| A_{OL} | Open-loop voltage gain | $R_L = 10\text{ k}\Omega$, $100\text{ mV} < V_O < (V_+) - 100\text{ mV}$ | 94 | 100 | | dB |
| | | OPA4364A | 90 | | | |
| | | Over temperature, $V_S = 1.8\text{ V to }5.5\text{ V}$ | 86 | | | dB |
| Frequency Response | | | | | | |
| GBW | Gain bandwidth product | $C_L = 100\text{ pF}$ | | 7 | | MHz |
| SR | Slew rate | $C_L = 100\text{ pF}$, $G = 1$ | | 5 | | $\text{V}/\mu\text{s}$ |
| t_s | Settling time | 0.1% | $C_L = 100\text{ pF}$, $V_S = 5\text{ V}$, 4-V step, $G = 1$ | 1 | | μs |
| | | 0.01% | $C_L = 100\text{ pF}$, $V_S = 5\text{ V}$, 4-V step, $G = 1$ | 1.5 | | μs |
| | Overload recovery time | $C_L = 100\text{ pF}$, $V_{IN} \times \text{Gain} > V_S$ | | 0.8 | | μs |
| THD+N | Total harmonic distortion + noise | $C_L = 100\text{ pF}$, $V_S = 5\text{ V}$, $G = 1$, $f = 20\text{ Hz to }20\text{ kHz}$ | | 0.002% | | |
| Output | | | | | | |
| Voltage output swing | From rail | $R_L = 10\text{ k}\Omega$ | | 10 | 20 | mV |
| | Over temperature | $R_L = 10\text{ k}\Omega$ | V_{OL} | | 20 | mV |
| | | | V_{OH} | | 40 | |
| I_{SC} | Short-circuit current | | See Typical Characteristics | | | |
| C_{LOAD} | Capacitive load drive | | See Typical Characteristics | | | |
| Power Supply | | | | | | |
| V_S | Specified voltage | | 1.8 | | 5.5 | V |
| | Operating voltage | | 1.8 to 5.5 | | | V |
| I_Q | Quiescent current (per amplifier) | $V_S = 1.8\text{ V}$ | | 650 | 750 | μA |
| | | $V_S = 3.6\text{ V}$ | | 850 | 1000 | μA |
| | | $V_S = 5.5\text{ V}$ | | 1.1 | 1.4 | mA |

ELECTRICAL CHARACTERISTICS: $V_S = 1.8\text{ V to }5.5\text{ V}$ (continued)

Boldface limits apply over the specified temperature range, $T_A = -40^\circ\text{C to }125^\circ\text{C}$, $T_A = 25^\circ\text{C}$, $R_L = 10\text{ k}\Omega$ connected to $V_S/2$, and $V_{OUT} = V_S/2$, $V_{CM} = V_S/2$ (unless otherwise noted)

| PARAMETER | | TEST CONDITIONS | MIN | TYP | MAX | UNIT |
|--------------------------|--------------------|-----------------|-----|-----|-----|--------------------|
| Temperature Range | | | | | | |
| Specified range | | | -40 | | 125 | $^\circ\text{C}$ |
| Storage range | | | -65 | | 150 | $^\circ\text{C}$ |
| θ_{JA} | Thermal resistance | SO-8 | | 150 | | $^\circ\text{C/W}$ |
| | | SO-14 | | 100 | | |

TYPICAL CHARACTERISTICS

At $T_{CASE} = 25^{\circ}C$, $R_L = 10\text{ k}\Omega$, and connected to $V_S/2$, $V_{OUT} = V_S/2$, $V_{CM} = V_S/2$ (unless otherwise noted)

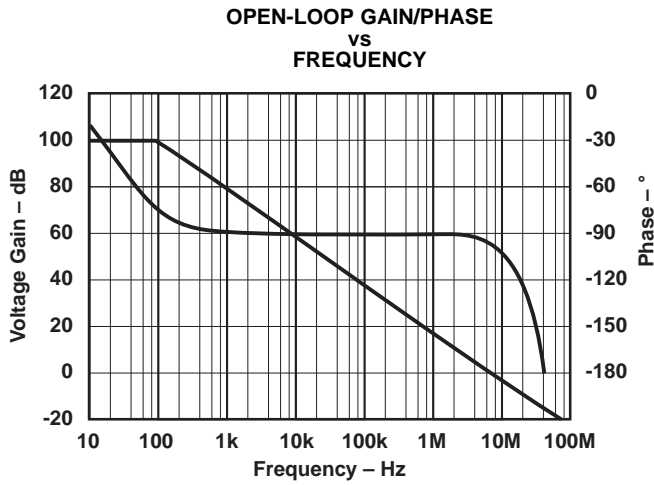

Figure 1.

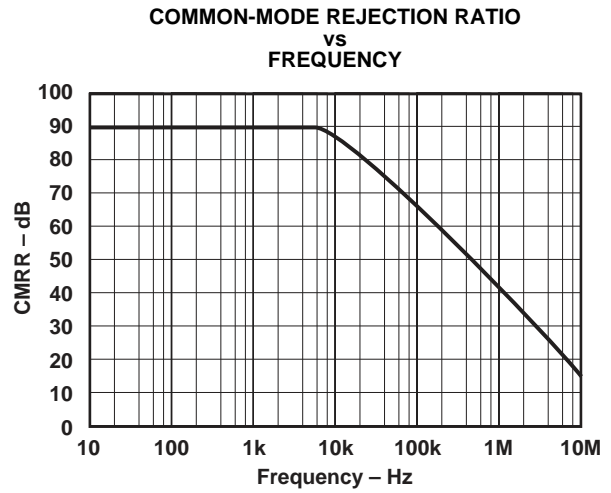

Figure 2.

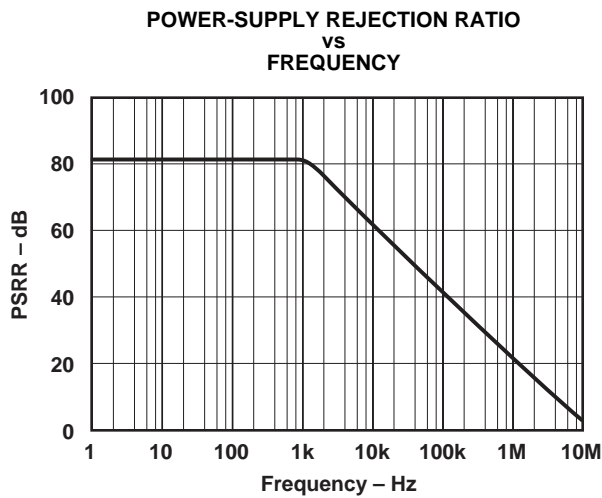

Figure 3.

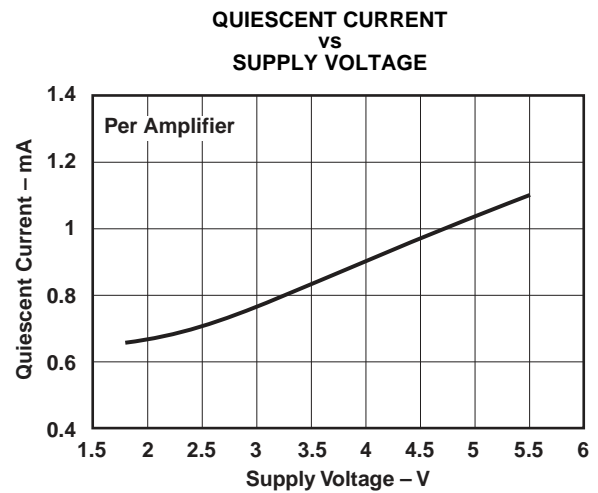

Figure 4.

TYPICAL CHARACTERISTICS (continued)

At $T_{CASE} = 25^{\circ}C$, $R_L = 10\text{ k}\Omega$, and connected to $V_S/2$, $V_{OUT} = V_S/2$, $V_{CM} = V_S/2$ (unless otherwise noted)

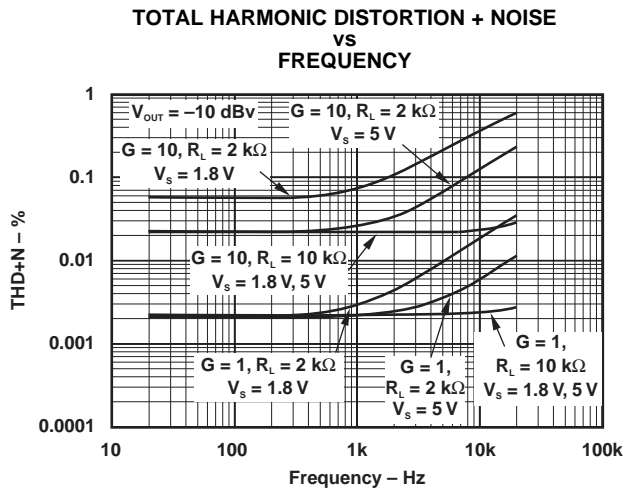

Figure 5.

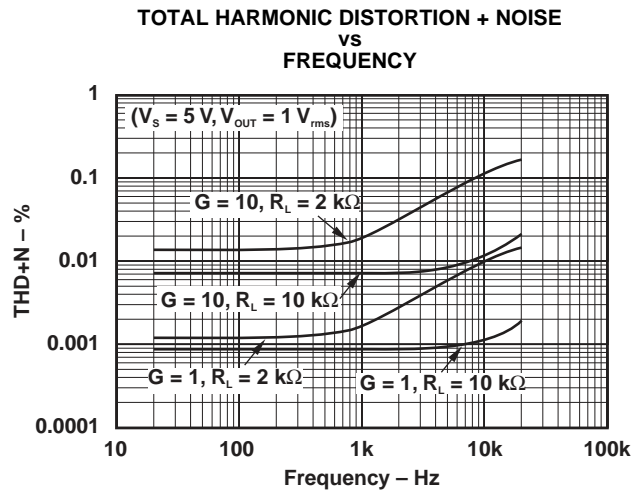

Figure 6.

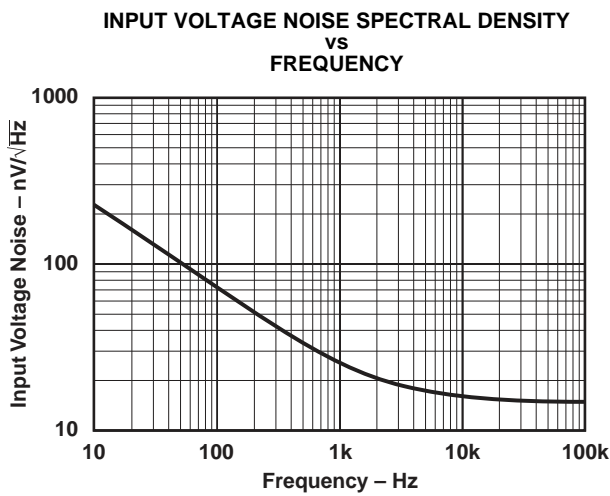

Figure 7.

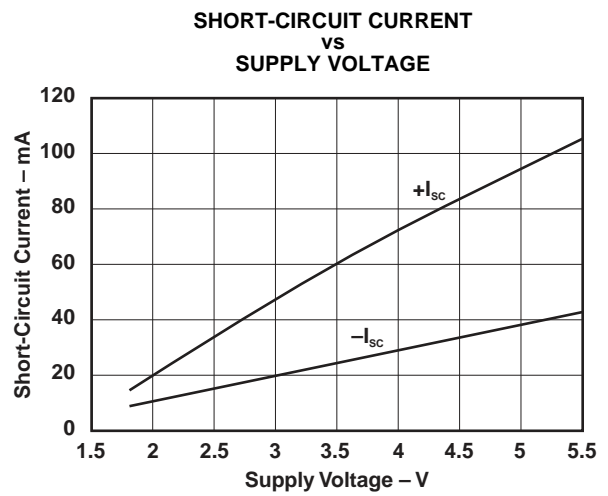

Figure 8.

TYPICAL CHARACTERISTICS (continued)

At $T_{CASE} = 25^{\circ}C$, $R_L = 10\text{ k}\Omega$, and connected to $V_S/2$, $V_{OUT} = V_S/2$, $V_{CM} = V_S/2$ (unless otherwise noted)

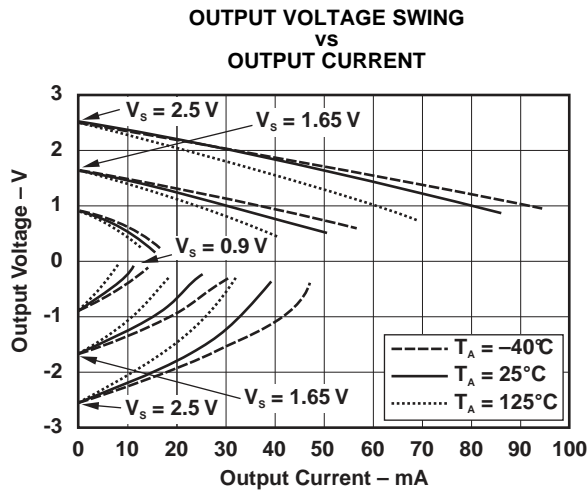

Figure 9.

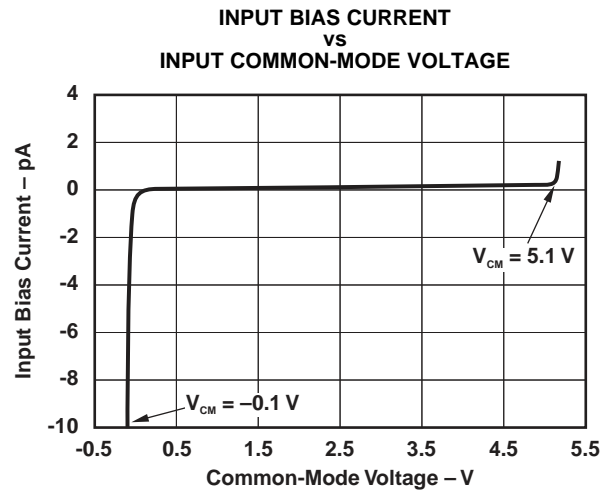

Figure 10.

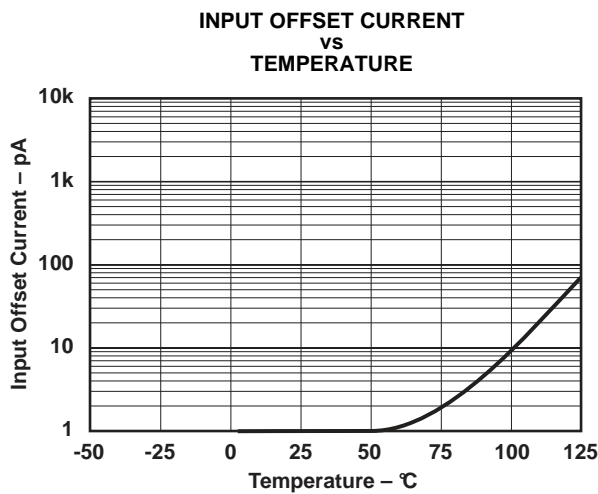

Figure 11.

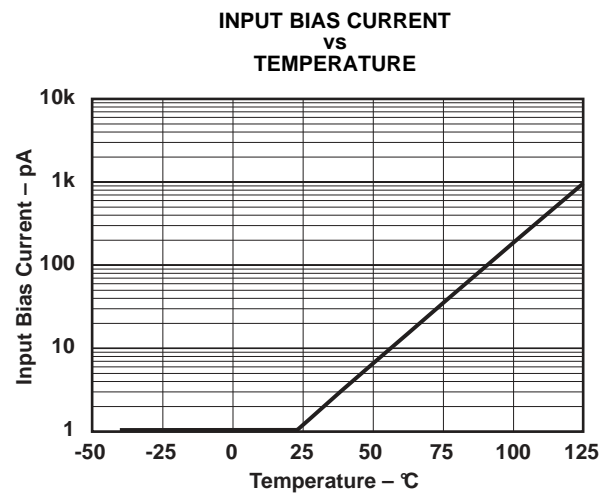

Figure 12.

TYPICAL CHARACTERISTICS (continued)

At $T_{CASE} = 25^{\circ}C$, $R_L = 10\text{ k}\Omega$, and connected to $V_S/2$, $V_{OUT} = V_S/2$, $V_{CM} = V_S/2$ (unless otherwise noted)

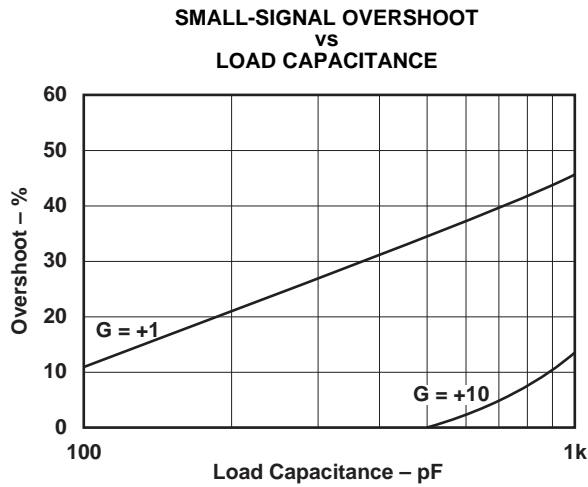

Figure 13.

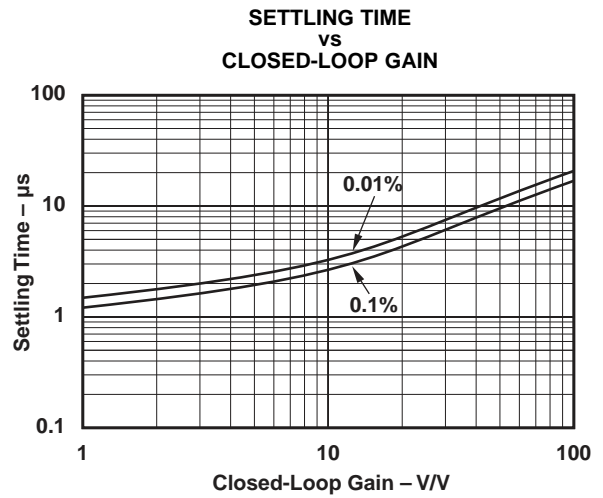

Figure 14.

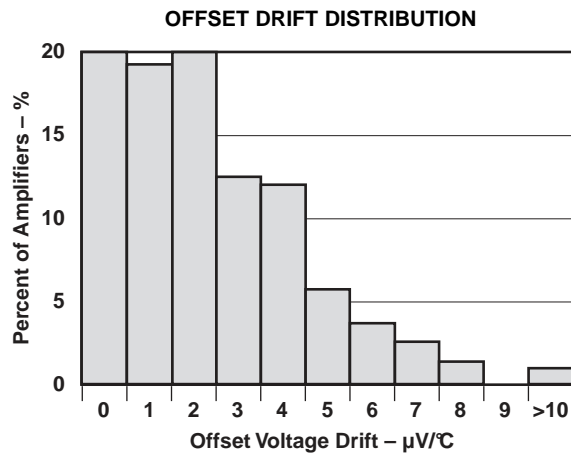

Figure 15.

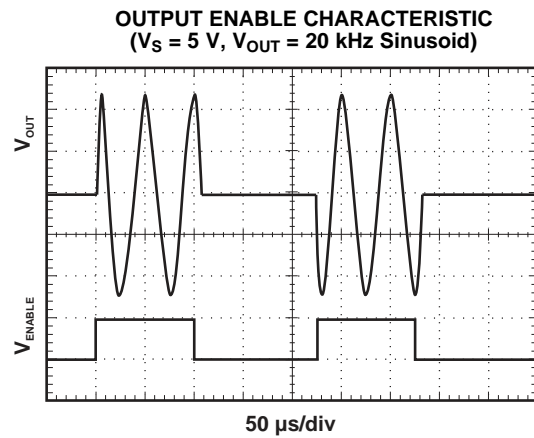

Figure 16.

TYPICAL CHARACTERISTICS (continued)

At $T_{CASE} = 25^{\circ}C$, $R_L = 10\text{ k}\Omega$, and connected to $V_S/2$, $V_{OUT} = V_S/2$, $V_{CM} = V_S/2$ (unless otherwise noted)

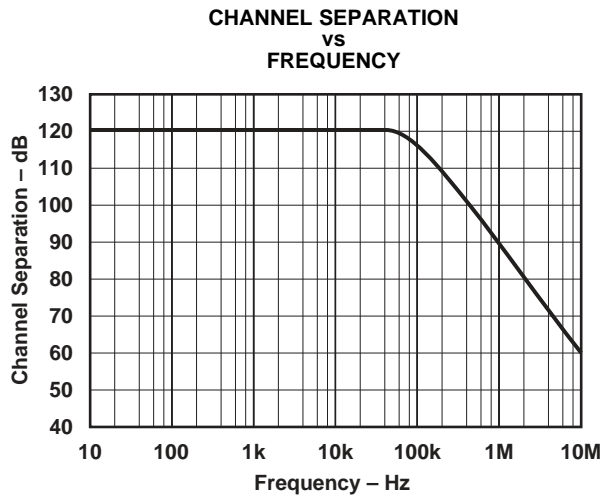

Figure 17.

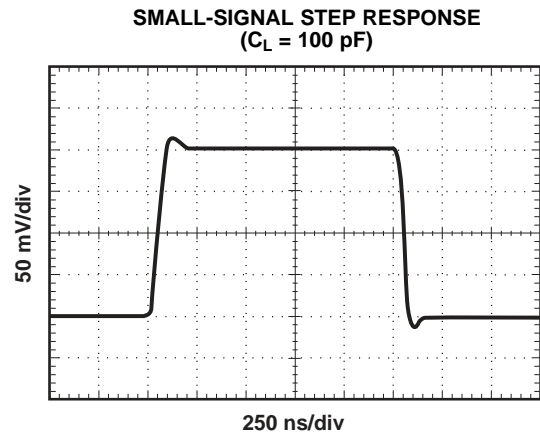

Figure 18.

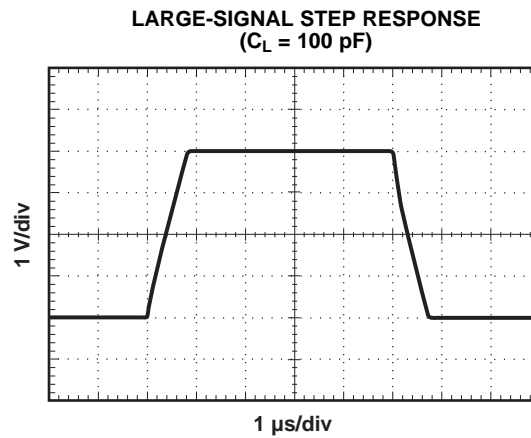

Figure 19.

APPLICATION INFORMATION

The OPAx364 series op amps are rail-to-rail operational amplifiers with excellent CMRR, low noise, low offset, and wide bandwidth on supply voltages as low as ± 0.9 V. This family does not exhibit phase reversal and is unity-gain stable. Specified over the industrial temperature range of -40°C to 125°C , the OPAx364 family offers precision performance for a wide range of applications.

Rail-to-Rail Input

The OPAx364 features excellent rail-to-rail operation, with supply voltages as low as ± 0.9 V. The input common-mode voltage range of the OPAx364 family extends 100 mV beyond supply rails. The unique input topology of the OPAx364 eliminates the input offset transition region typical of most rail-to-rail complimentary stage operational amplifiers, allowing the OPAx364 to provide superior common-mode performance over the entire common-mode input range (see Figure 20). This feature prevents degradation of the differential linearity error and THD when driving A/D converters. A simplified schematic of the OPAx364 is shown in Figure 21.

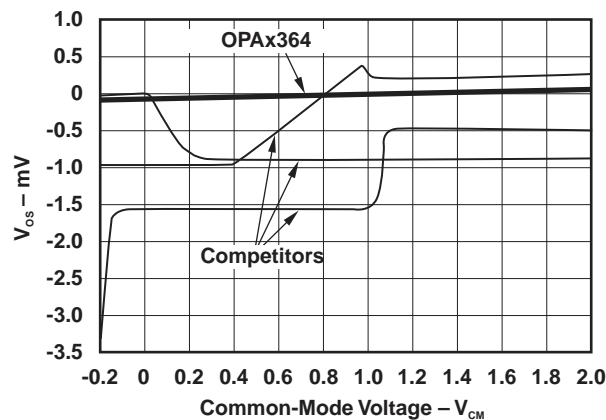

Figure 20. OPAx364 Linear Offset Over Entire Common-Mode Range

APPLICATION INFORMATION (continued)

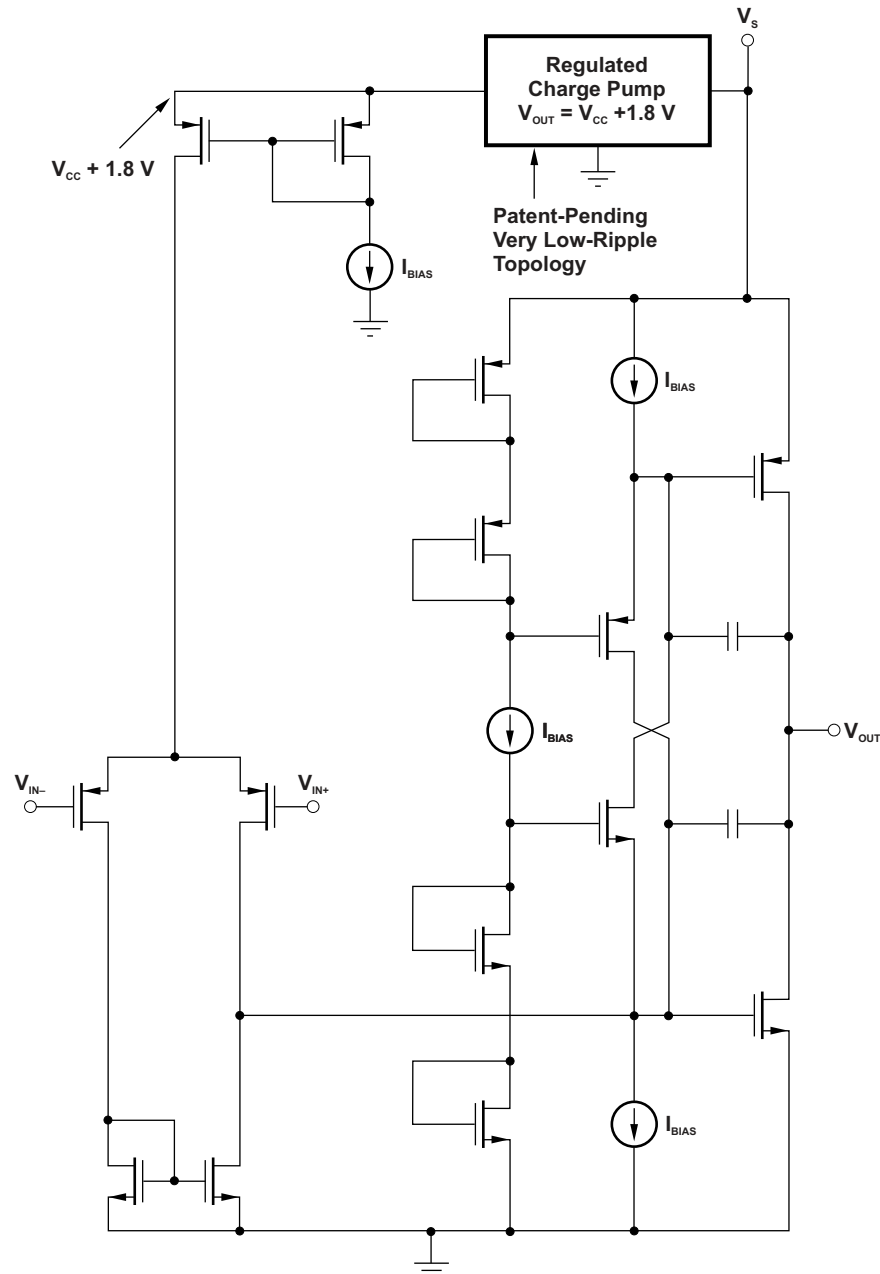

Figure 21. Simplified Schematic

Operating Voltage

The OPAx364 series of operational amplifier parameters are fully specified from 1.8 V to 5.5 V. Single 0.1- μ F bypass capacitors should be placed across supply pins and as close to the part as possible. Supply voltages higher than 5.5 V (absolute maximum) may cause permanent damage to the amplifier. Many specifications apply from -40°C to 125°C . Parameters that vary significantly with operating voltages or temperature are shown in the Typical Characteristics.

APPLICATION INFORMATION (continued)

Capacitive Load

The OPAx364 series operational amplifiers can drive a wide range of capacitive loads. However, all operational amplifiers under certain conditions may become unstable. Operational amplifier configuration, gain, and load value are just a few of the factors to consider when determining stability. An operational amplifier in unity-gain configuration is the most susceptible to the effects of capacitive load. The capacitive load reacts with the output resistance of the operational amplifier to create a pole in the small-signal response, which degrades the phase margin.

In unity gain, the OPAx364 series operational amplifiers perform well with a pure capacitive load up to approximately 1000 pF. The equivalent series resistance (ESR) of the loading capacitor may be sufficient to allow the OPAx364 to directly drive large capacitive loads ($>1 \mu\text{F}$). Increasing gain enhances the amplifier's ability to drive more capacitance as shown in [Figure 13](#).

One method of improving capacitive load drive in the unity gain configuration is to insert a 10- Ω to 20- Ω resistor in series with the output, as shown in [Figure 22](#). This significantly reduces ringing with large capacitive loads. However, if there is a resistive load in parallel with the capacitive load, it creates a voltage divider introducing a dc error at the output and slightly reduces output swing. This error may be insignificant. For instance, with $R_L = 10 \text{ k}\Omega$ and $R_S = 20 \Omega$, there is only about a 0.2% error at the output.

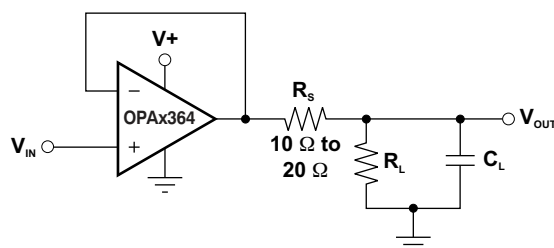

Figure 22. Improving Capacitive Load Drive

Input and ESD Protection

All OPAx364 pins are static protected with internal ESD protection diodes tied to the supplies. These diodes provide overdrive protection if the current is externally limited to 10 mA, as stated in the absolute maximum ratings and shown in [Figure 23](#).

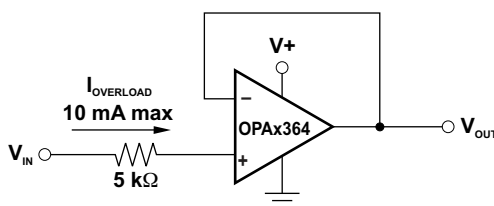

Figure 23. Input Current Protection

Achieving Output Swing to the Operational Amplifier's Negative Rail

Some applications require an accurate output voltage swing from 0 V to a positive full-scale voltage. A good single-supply operational amplifier may be able to swing within a few mV of single supply ground, but as the output is driven toward 0 V, the output stage of the amplifier prevents the output from reaching the negative supply rail of the amplifier.

The output of the OPAx364 can be made to swing to ground, or slightly below, on a single-supply power source. To do so requires use of another resistor and an additional, more-negative power supply than the operational amplifier's negative supply. A pulldown resistor may be connected between the output and the additional negative supply to pull the output down below the value that the output would otherwise achieve as shown in [Figure 24](#).

APPLICATION INFORMATION (continued)

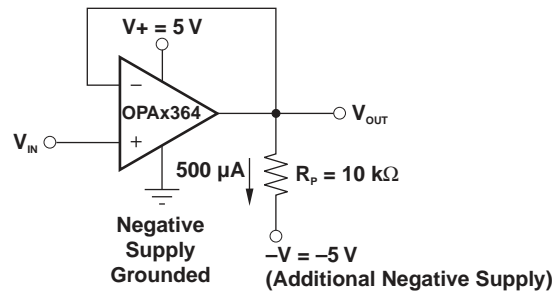

Figure 24. Swing to Ground

This technique does not work with all operational amplifiers. The output stage of the OPAx364 allows the output voltage to be pulled below that of most operational amplifiers, if approximately 500 μA is maintained through the output stage. To calculate the appropriate value load resistor and negative supply, $R_L = -V/500 \mu\text{A}$. The OPAx364 has been characterized to perform well under the described conditions, maintaining excellent accuracy down to 0 V and as low as -10 mV . Limiting and nonlinearity occurs below -10 mV , with linearity returning as the output is again driven above -10 mV .

Buffered Reference Voltage

Many single-supply applications require a mid-supply reference voltage. The OPAx364 offer excellent capacitive load drive capability and can be configured to provide a 0.9-V reference voltage (see [Figure 25](#)). For appropriate loading considerations, see the Capacitive Load section.

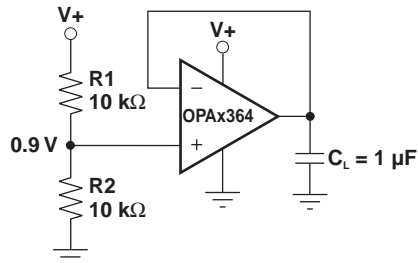

Figure 25. OPAx364 Provides a Stable Reference Voltage

APPLICATION INFORMATION (continued)

Directly Driving the ADS8324 and the MSP430

The OPAx364 series operational amplifiers are optimized for driving medium speed (up to 100 kHz) sampling A/D converters. However, they also offer excellent performance for higher-speed converters. The no crossover input stage of the OPAx364 directly drives A/D converters without degradation of differential linearity and THD. They provide an effective means of buffering the A/D converters input capacitance and resulting charge injection, while providing signal gain. Figure 26 and Figure 27 show the OPAx364 configured to drive the ADS8324 and the 12-bit A/D converter on the MSP430.

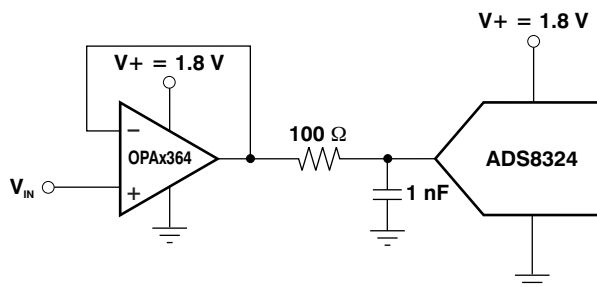

Figure 26. OPAx364 Directly Drives the ADS8324

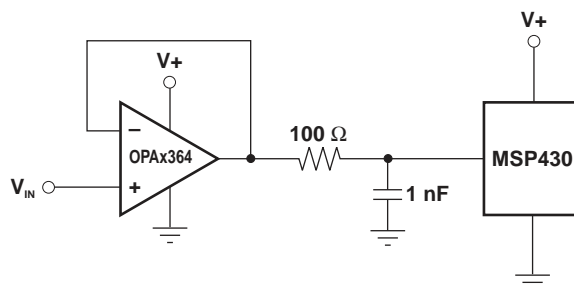

Figure 27. Driving the 12-Bit A/D Converter on the MSP430

Audio Applications

The OPAx364 family has linear offset voltage over the entire input common-mode range. Combined with low-noise, this feature makes the OPAx364 suitable for audio applications. Single-supply 1.8-V operation allows the OPA2364 to be an optimal candidate for dual stereo-headphone drivers and microphone preamplifiers in portable stereo equipment (see Figure 28).

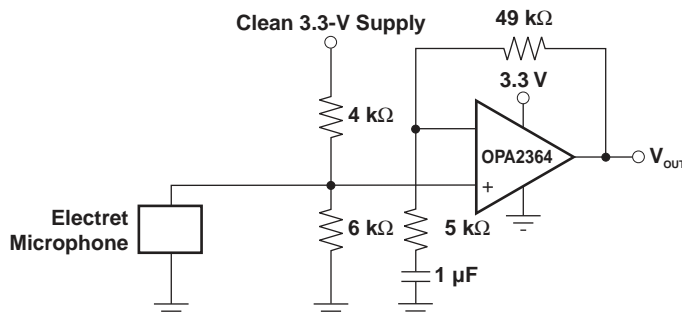

Figure 28. Microphone Preamplifier

APPLICATION INFORMATION (continued)

Active Filtering

Low harmonic distortion and noise specifications plus high gain and slew rate make the OPAx364 optimal candidates for active filtering. [Figure 29](#) shows the implementation of a Sallen-Key, 3-pole, low-pass Bessel filter.

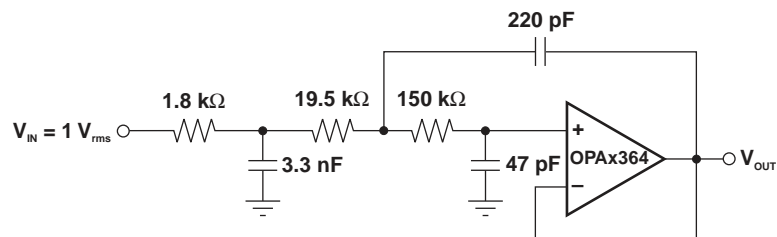

Figure 29. OPAx364 Configured as 3-Pole, 20-kHz, Sallen-Key Filter

PACKAGING INFORMATION

| Orderable Device | Status (1) | Package Type | Package Drawing | Pins | Package Qty | Eco Plan (2) | Lead finish/ Ball material (6) | MSL Peak Temp (3) | Op Temp (°C) | Device Marking (4/5) | Samples |
|------------------|---------------|--------------|--------------------|------|----------------|-----------------|--------------------------------------|----------------------|--------------|-------------------------|---------|
| OPA4364AQDRQ1 | ACTIVE | SOIC | D | 14 | 2500 | RoHS & Green | NIPDAU | Level-1-260C-UNLIM | -40 to 125 | OPA4364Q | Samples |

(1) The marketing status values are defined as follows:

ACTIVE: Product device recommended for new designs.

LIFEBUY: TI has announced that the device will be discontinued, and a lifetime-buy period is in effect.

NRND: Not recommended for new designs. Device is in production to support existing customers, but TI does not recommend using this part in a new design.

PREVIEW: Device has been announced but is not in production. Samples may or may not be available.

OBSOLETE: TI has discontinued the production of the device.

(2) **RoHS:** TI defines "RoHS" to mean semiconductor products that are compliant with the current EU RoHS requirements for all 10 RoHS substances, including the requirement that RoHS substance do not exceed 0.1% by weight in homogeneous materials. Where designed to be soldered at high temperatures, "RoHS" products are suitable for use in specified lead-free processes. TI may reference these types of products as "Pb-Free".

RoHS Exempt: TI defines "RoHS Exempt" to mean products that contain lead but are compliant with EU RoHS pursuant to a specific EU RoHS exemption.

Green: TI defines "Green" to mean the content of Chlorine (Cl) and Bromine (Br) based flame retardants meet JS709B low halogen requirements of <=1000ppm threshold. Antimony trioxide based flame retardants must also meet the <=1000ppm threshold requirement.

(3) MSL, Peak Temp. - The Moisture Sensitivity Level rating according to the JEDEC industry standard classifications, and peak solder temperature.

(4) There may be additional marking, which relates to the logo, the lot trace code information, or the environmental category on the device.

(5) Multiple Device Markings will be inside parentheses. Only one Device Marking contained in parentheses and separated by a "-" will appear on a device. If a line is indented then it is a continuation of the previous line and the two combined represent the entire Device Marking for that device.

(6) Lead finish/Ball material - Orderable Devices may have multiple material finish options. Finish options are separated by a vertical ruled line. Lead finish/Ball material values may wrap to two lines if the finish value exceeds the maximum column width.

Important Information and Disclaimer: The information provided on this page represents TI's knowledge and belief as of the date that it is provided. TI bases its knowledge and belief on information provided by third parties, and makes no representation or warranty as to the accuracy of such information. Efforts are underway to better integrate information from third parties. TI has taken and continues to take reasonable steps to provide representative and accurate information but may not have conducted destructive testing or chemical analysis on incoming materials and chemicals. TI and TI suppliers consider certain information to be proprietary, and thus CAS numbers and other limited information may not be available for release.

In no event shall TI's liability arising out of such information exceed the total purchase price of the TI part(s) at issue in this document sold by TI to Customer on an annual basis.

OTHER QUALIFIED VERSIONS OF OPA4364-Q1 :

- Catalog: [OPA4364](#)

NOTE: Qualified Version Definitions:

- Catalog - TI's standard catalog product

TAPE AND REEL INFORMATION

QUADRANT ASSIGNMENTS FOR PIN 1 ORIENTATION IN TAPE

*All dimensions are nominal

| Device | Package Type | Package Drawing | Pins | SPQ | Reel Diameter (mm) | Reel Width W1 (mm) | A0 (mm) | B0 (mm) | K0 (mm) | P1 (mm) | W (mm) | Pin1 Quadrant |
|---------------|--------------|-----------------|------|------|--------------------|--------------------|---------|---------|---------|---------|--------|---------------|
| OPA4364AQDRQ1 | SOIC | D | 14 | 2500 | 330.0 | 16.4 | 6.5 | 9.0 | 2.1 | 8.0 | 16.0 | Q1 |

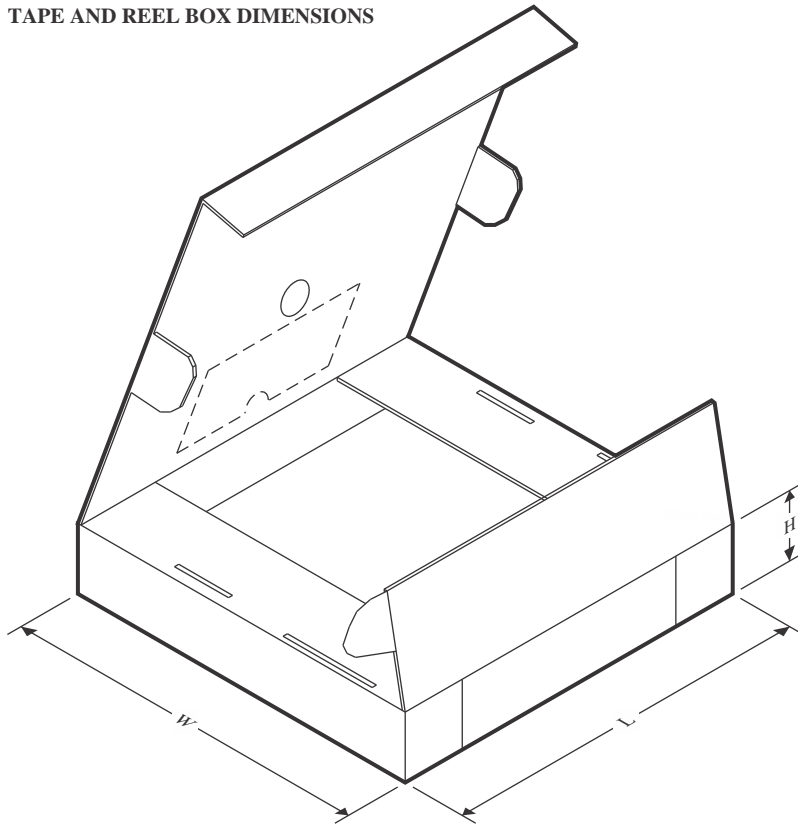
TAPE AND REEL BOX DIMENSIONS



*All dimensions are nominal

| Device | Package Type | Package Drawing | Pins | SPQ | Length (mm) | Width (mm) | Height (mm) |
|---------------|--------------|-----------------|------|------|-------------|------------|-------------|
| OPA4364AQDRQ1 | SOIC | D | 14 | 2500 | 356.0 | 356.0 | 35.0 |

D (R-PDSO-G14)

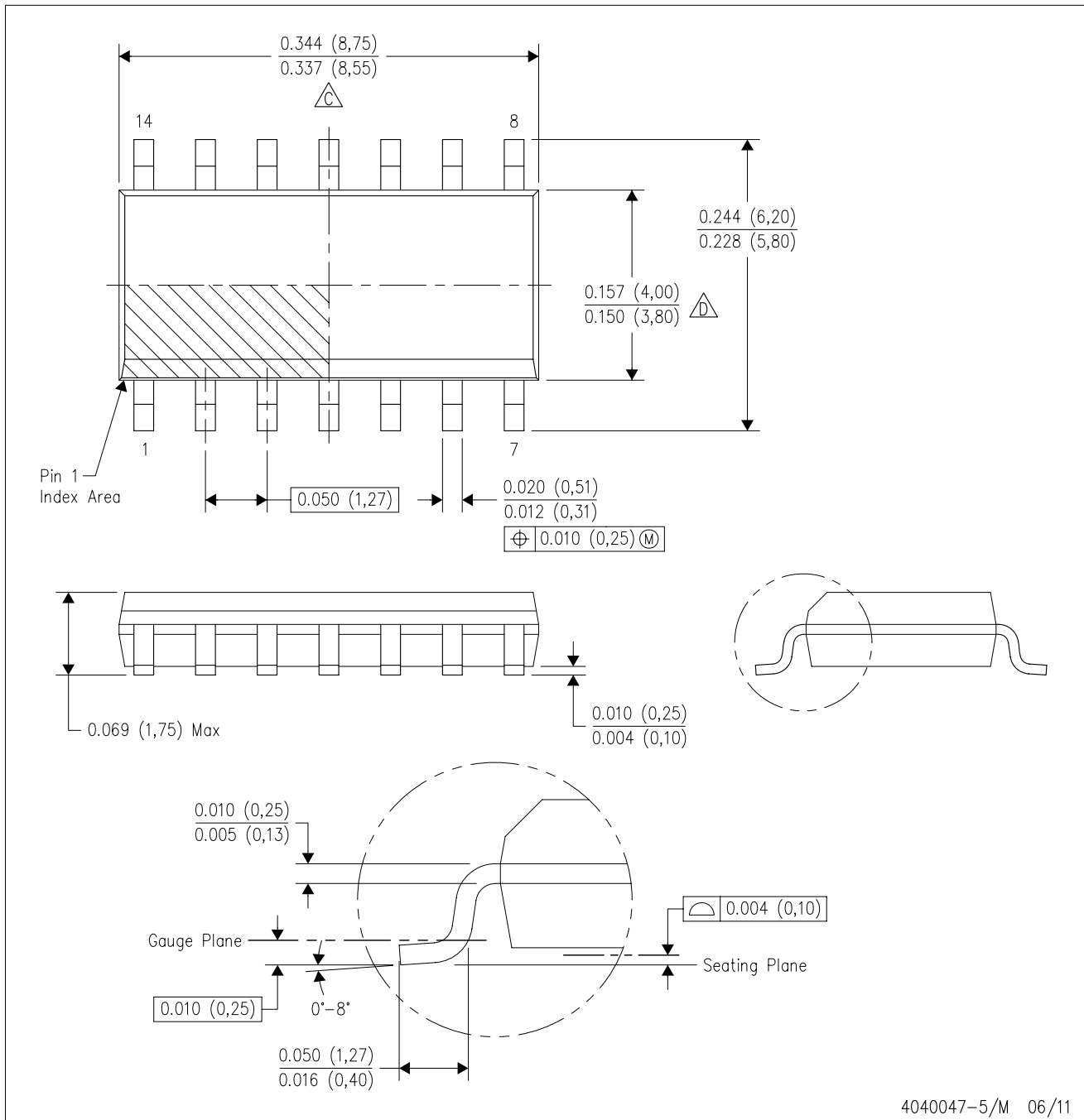
PLASTIC SMALL OUTLINE



- NOTES:
- A. All linear dimensions are in inches (millimeters).
 - B. This drawing is subject to change without notice.
 -  Body length does not include mold flash, protrusions, or gate burrs. Mold flash, protrusions, or gate burrs shall not exceed 0.006 (0,15) each side.
 -  Body width does not include interlead flash. Interlead flash shall not exceed 0.017 (0,43) each side.
 - E. Reference JEDEC MS-012 variation AB.

D (R-PDSO-G14)

PLASTIC SMALL OUTLINE

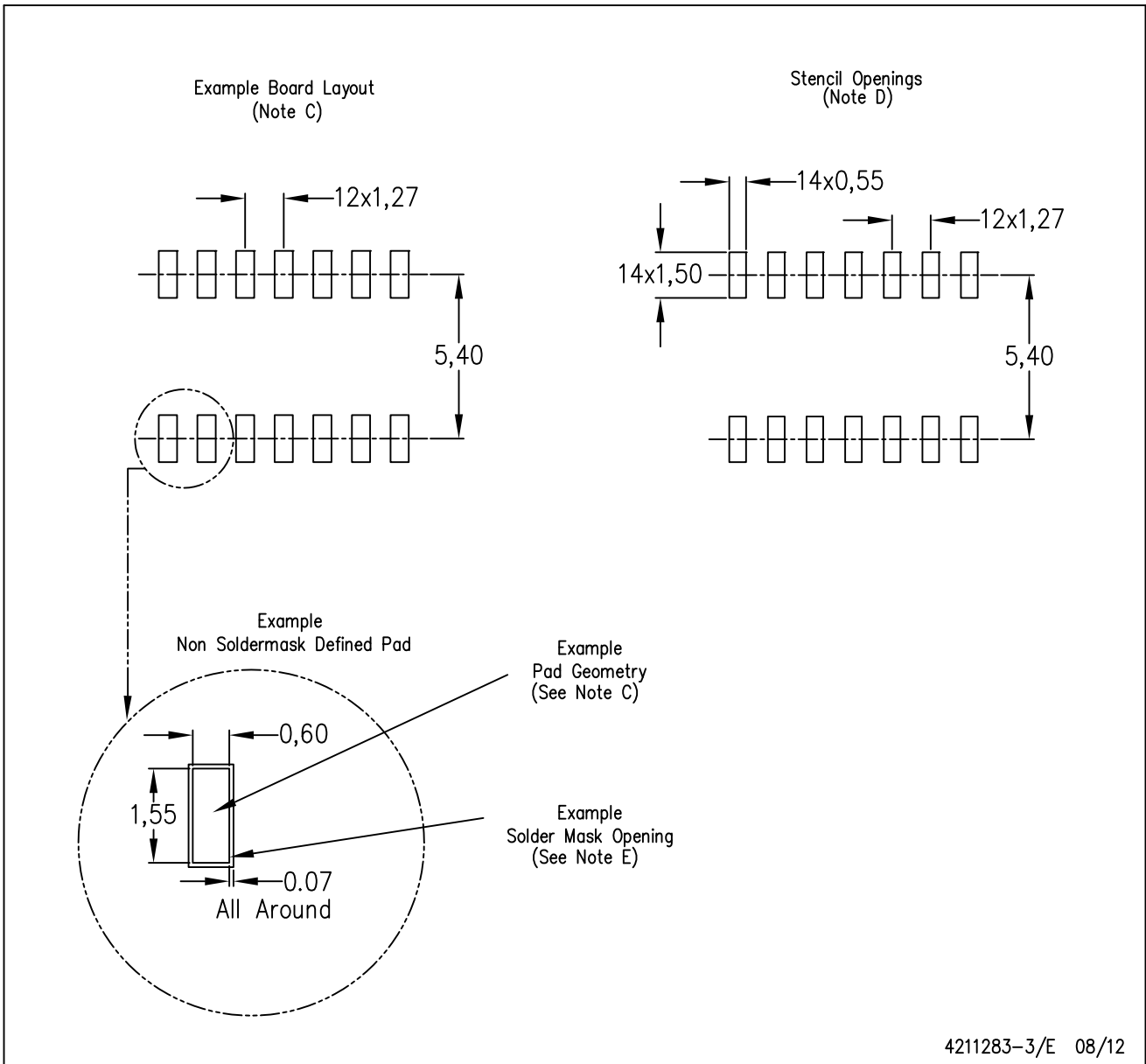

- NOTES:
- All linear dimensions are in millimeters.
 - This drawing is subject to change without notice.
 - Publication IPC-7351 is recommended for alternate designs.
 - Laser cutting apertures with trapezoidal walls and also rounding corners will offer better paste release. Customers should contact their board assembly site for stencil design recommendations. Refer to IPC-7525 for other stencil recommendations.
 - Customers should contact their board fabrication site for solder mask tolerances between and around signal pads.

IMPORTANT NOTICE AND DISCLAIMER

TI PROVIDES TECHNICAL AND RELIABILITY DATA (INCLUDING DATA SHEETS), DESIGN RESOURCES (INCLUDING REFERENCE DESIGNS), APPLICATION OR OTHER DESIGN ADVICE, WEB TOOLS, SAFETY INFORMATION, AND OTHER RESOURCES "AS IS" AND WITH ALL FAULTS, AND DISCLAIMS ALL WARRANTIES, EXPRESS AND IMPLIED, INCLUDING WITHOUT LIMITATION ANY IMPLIED WARRANTIES OF MERCHANTABILITY, FITNESS FOR A PARTICULAR PURPOSE OR NON-INFRINGEMENT OF THIRD PARTY INTELLECTUAL PROPERTY RIGHTS.

These resources are intended for skilled developers designing with TI products. You are solely responsible for (1) selecting the appropriate TI products for your application, (2) designing, validating and testing your application, and (3) ensuring your application meets applicable standards, and any other safety, security, regulatory or other requirements.

These resources are subject to change without notice. TI grants you permission to use these resources only for development of an application that uses the TI products described in the resource. Other reproduction and display of these resources is prohibited. No license is granted to any other TI intellectual property right or to any third party intellectual property right. TI disclaims responsibility for, and you will fully indemnify TI and its representatives against, any claims, damages, costs, losses, and liabilities arising out of your use of these resources.

TI's products are provided subject to [TI's Terms of Sale](#) or other applicable terms available either on ti.com or provided in conjunction with such TI products. TI's provision of these resources does not expand or otherwise alter TI's applicable warranties or warranty disclaimers for TI products.

TI objects to and rejects any additional or different terms you may have proposed.

Mailing Address: Texas Instruments, Post Office Box 655303, Dallas, Texas 75265
Copyright © 2022, Texas Instruments Incorporated