

# Am25LS14A

8-Bit Serial/Parallel Two's Complement Multiplier

## DISTINCTIVE CHARACTERISTICS

- Two's complement multiplication without correction
- Magnitude only multiplication
- Cascadable for any number of bits
- 8-bit parallel multiplicand data input
- 50MHz minimum clock frequency
- Second sourced by T.I. as the SN54LS/74LS384
- IMOX™ process with ECL internal

## GENERAL DESCRIPTION

The Am25LS14A is an 8-bit by 1-bit sequential logic element that performs digital multiplication of two numbers represented in two's complement form to produce a two's complement product without correction. The device accepts an 8-bit multiplicand (X input) and stores this data in eight internal latches. The X latches are controlled via the clear input. When the clear input is LOW, all internal flip-flops are cleared and the X latches are opened to accept new multiplicand data. When the clear input is HIGH, the latches are closed and are insensitive to X input changes.

The multiplier word data is passed by the Y input in a serial bit stream – least significant bit first. The product is clocked out the S output least significant bit first.

The multiplication of an m-bit multiplicand by an n-bit multiplier results in an  $m + n$  bit product. The Am25LS14A must be clocked for  $m + n$  clock cycles to produce this two's complement product. Likewise, the n-bit multiplier (Y-input) sign bit data must be extended for the remaining m-bits to complete the multiplication cycle.

The device also contains a K input so that devices can be cascaded for longer length X words. The sum (S) output of one device is connected to the K input of the succeeding device when cascading. Likewise, a mode input (M) is used to indicate which device contains the most significant bit. The mode input is wired HIGH or LOW depending on the position of the 8-bit slice in the total X word length.

## BLOCK DIAGRAM

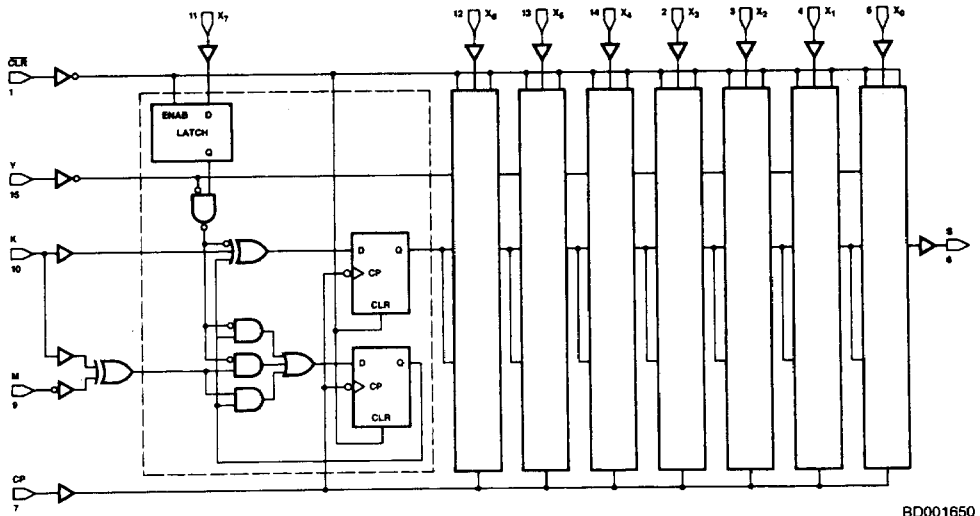

### CONNECTION DIAGRAM Top View

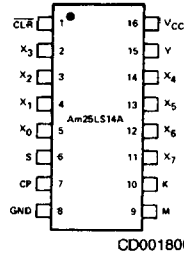

Note: Pin 1 is marked for orientation

### LOGIC SYMBOL

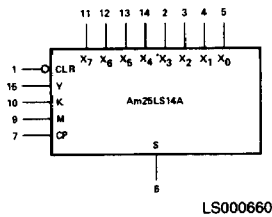

### METALLIZATION AND PAD LAYOUT

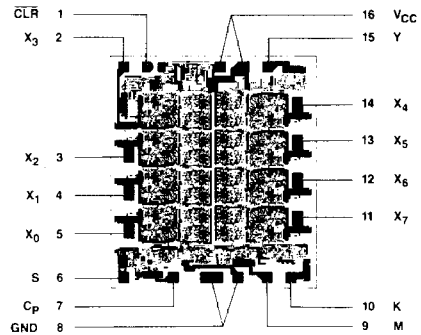

DIE SIZE 0.084" x 0.095"

### ORDERING INFORMATION

AMD products are available in several packages and operating ranges. The order number is formed by a combination of the following: Device number, speed option (if applicable), package type, operating range and screening option (if desired).

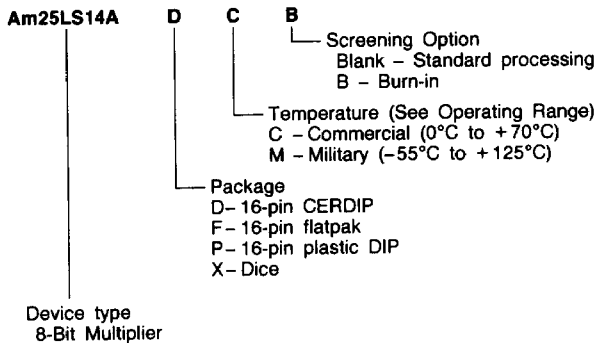

#### Valid Combinations

Am25LS14A	PC
	DC, DM
	FM
	XC, XM

#### Valid Combinations

Consult the AMD sales office in your area to determine if a device is currently available in the combination you wish.

## PIN DESCRIPTION

Pin No.	Name	I/O	Description
	X <sub>0</sub> , X <sub>1</sub> , X <sub>2</sub> , X <sub>3</sub> , X <sub>4</sub> , X <sub>5</sub> , X <sub>6</sub> , X <sub>7</sub>	I	The eight data inputs for the multiplicand (X) data.
15	Y	I	The serial input for the multiplier (Y) data—least significant bit first.
6	S	O	The serial output for the product of $X \cdot Y$ —least significant bit first.
7	CP	I	Clock. The buffered common clock input for the serial/parallel multiplier. All functions occur on the LOW-to-HIGH transition of the clock.
1	CLR	I	Clear. The buffered common clear for all flip-flops within the device. When the clear is LOW all flip-flops are cleared. Also the buffered X-input latch enable. When the clear input is LOW, the X latches will accept new X-input data.
10	K	I	The sum expansion input to the serial/parallel multiplier. Allows for cascading devices.
9	M	I	The mode control input for the most significant bit of the multiplier. It is used in conjunction with cascading to determine the most significant bit.

## FUNCTION TABLE

INPUTS						INTERNAL	OUTPUT	FUNCTION
CLR	CP	K	M	X <sub>i</sub>	Y	Y <sub>-1</sub>	S	
-	-	L	L	-	-	-	-	Most Significant Multiplier Device
-	-	CS	H	-	-	-	-	Devices Cascaded in Multiplier String
L	-	-	-	OP	-	L	L	Load New Multiplicand and Clear Internal Sum and Carry Registers
H	-	-	-	-	-	-	-	Device Enabled
H	↑	-	-	-	L	L	AR	Shift Sum Register
H	↑	-	-	-	L	H	AR	Add Multiplicand to Sum Register and Shift
H	↑	-	-	-	H	L	AR	Subtract Multiplicand from Sum Register and Shift
H	↑	-	-	-	H	H	AR	Shift Sum Register

H = HIGH

L = LOW

↑ = LOW-to-HIGH transition

CS = Connected to S output of higher order device

OP = X<sub>i</sub> latches open for new data (i = 0, 7)

AR = Output as required

## DEFINITION OF STANDARD TERMS

H HIGH, applying to a HIGH voltage level.

L LOW, applying to a LOW voltage level.

I Input.

O Output.

**Negative Current** Current flowing out of the device.**Positive Current** Current flowing into the device.**I<sub>IL</sub>** LOW-level input current with a specified LOW-level voltage applied.**I<sub>IH</sub>** HIGH-level input current with a specified HIGH-level voltage applied.**I<sub>OL</sub>** LOW-level output current.**I<sub>OH</sub>** HIGH-level output current.**I<sub>SC</sub>** Output short-circuit source current.**I<sub>CC</sub>** The supply current drawn by the device from the VCC power supply.**V<sub>IL</sub>** Logic LOW input voltage.**V<sub>IH</sub>** Logic HIGH input voltage.**V<sub>OL</sub>** LOW-level output voltage with I<sub>OL</sub> applied.**V<sub>OH</sub>** HIGH-level output voltage with I<sub>OH</sub> applied.



**ABSOLUTE MAXIMUM RATINGS**

Storage Temperature .....	-65°C to +150°C
(Ambient) Temperature Under Bias .....	-55°C to +125°C
Supply Voltage to Ground Potential	
Continuous .....	-0.5V to +7.0V
DC Voltage Applied to Outputs For	
High Output State .....	-0.5V to +V <sub>CC</sub> max
DC Input Voltage .....	-0.5V to +5.5V
DC Output Current, Into Outputs .....	30mA
DC Input Current .....	-30mA to +5.0mA

Stresses above those listed under ABSOLUTE MAXIMUM RATINGS may cause permanent device failure. Functionality at or above these limits is not implied. Exposure to absolute maximum ratings for extended periods may affect device reliability.

**OPERATING RANGES****Commercial (C) Devices**

Temperature .....	0°C to +70°C
Supply Voltage .....	+4.75V to +5.25V

**Military (M) Devices**

Temperature .....	-55°C to +125°C
Supply Voltage .....	+4.5V to +5.5V

Operating ranges define those limits over which the functionality of the device is guaranteed.

**DC CHARACTERISTICS** over operating range unless otherwise specified

Parameters	Description	Test Conditions (Note 2)	Min	Typ (Note 1)	Max	Units	
V <sub>OH</sub>	Output HIGH Voltage	V <sub>CC</sub> = MIN., I <sub>OH</sub> = -1.0mA V <sub>IN</sub> = V <sub>IH</sub> or V <sub>IL</sub>	MIL	2.5	3.4		Volts
			COM'L	2.7	3.4		
V <sub>OL</sub>	Output LOW Voltage	V <sub>CC</sub> = MIN. V <sub>IN</sub> = V <sub>IH</sub> or V <sub>IL</sub>	I <sub>OL</sub> = 8.0mA			0.4	Volts
			I <sub>OL</sub> = 12mA			0.45	
V <sub>IH</sub>	Input HIGH Level	Guaranteed input logical HIGH voltage for all inputs	2.0			Volts	
V <sub>IL</sub>	Input LOW Level	Guaranteed input logical LOW voltage for all inputs			0.8	Volts	
V <sub>I</sub>	Input Clamp Voltage	V <sub>CC</sub> = MIN., I <sub>IN</sub> = -18mA			-1.2	Volts	
I <sub>IL</sub>	Input LOW Current	V <sub>CC</sub> = MAX., V <sub>IN</sub> = 0.4V	X, M			-0.48	mA
			K, CLR			-1.2	
			CP			-1.6	
			Y			-3.2	
I <sub>IH</sub>	Input HIGH Current	V <sub>CC</sub> = MAX., V <sub>IN</sub> = 2.7V	X, M			20	μA
			K, CLR			30	
			CP			40	
			Y			80	
I <sub>I</sub>	Input HIGH Current	V <sub>CC</sub> = MAX., V <sub>IN</sub> = 5.5V			1.0	mA	
I <sub>SC</sub>	Output Short Circuit Current (Note 3)	V <sub>CC</sub> = MAX.	-15		-85	mA	
I <sub>CC</sub>	Power Supply Current	V <sub>CC</sub> = MAX.		45	65	mA	

Notes: 1. Typical limits are at V<sub>CC</sub> = 5.0V, 25°C ambient and maximum loading.

2. For conditions shown as MIN. or MAX., use the appropriate value specified under Operating Ranges for the applicable device type.

3. Duration of the short circuit test should not exceed one second.

**SWITCHING CHARACTERISTICS** ( $T_A = +25^\circ\text{C}$ ,  $V_{CC} = 5.0\text{V}$ )

Parameters	Description	Test Conditions	Min	Typ	Max	Units
t <sub>PLH</sub>	Clock to Output	C <sub>L</sub> = 15pF R <sub>L</sub> = 2.0kΩ		8	14	ns
t <sub>PHL</sub>				10	18	
t <sub>PHL</sub>	Clear to Output			9	17	ns
t <sub>s</sub>	Y to Clock			15		ns
t <sub>h</sub>				0		
t <sub>s</sub>	K to Clock			15		ns
t <sub>h</sub>				0		
t <sub>s</sub>	X <sub>i</sub> to Clear			13		ns
t <sub>h</sub>				0		
t <sub>pw</sub>	Clock (HIGH)			10		ns
	Clock (LOW)		10			
t <sub>pw</sub>	Clear Pulse Width		10		ns	
t <sub>s</sub>	Clear Recovery Time (Inactive State)		5		ns	
f <sub>max</sub> (Note 1)	Maximum Clock Frequency		50	60	MHz	

Note 1: Per industry convention, f<sub>max</sub> is the worst case value of the maximum device operating frequency with no constraints on t<sub>r</sub>, t<sub>f</sub>, pulse width or duty cycle.

**SWITCHING CHARACTERISTICS** over operating range unless otherwise specified\*

Parameters	Description	Test Conditions	Am25LS COMMERCIAL		Am25LS MILITARY		Units
			Min	Max	Min	Max	
t <sub>PLH</sub>	Clock to Output	C <sub>L</sub> = 50pF R <sub>L</sub> = 2.0kΩ		18		20	ns
t <sub>PHL</sub>				22		25	
t <sub>PHL</sub>	Clear to Output			22		25	ns
t <sub>s</sub>	Y to Clock			22		25	ns
t <sub>h</sub>				0		0	
t <sub>s</sub>	K to Clock			20		22	ns
t <sub>h</sub>				0		0	
t <sub>s</sub>	X <sub>i</sub> to Clear			20		22	ns
t <sub>h</sub>				0		0	
t <sub>pw</sub>	Clock (HIGH)			10		10	ns
	Clock (LOW)		10		10		
t <sub>pw</sub>	Clear Pulse Width		10		10	ns	
t <sub>s</sub>	Clear Recovery Time (Inactive State)		5		5	ns	
f <sub>max</sub> (Note 1)	Maximum Clock Frequency		50		50	MHz	

\*AC performance over the operating temperature range is guaranteed by testing defined in Group A, Subgroup 9.

### LOW CURRENT SCHOTTKY INPUT/OUTPUT CURRENT INTERFACE CONDITIONS

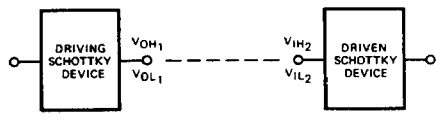
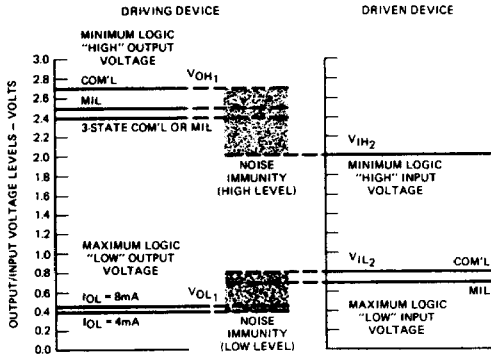

IC000210

Note: Refer to Electrical Characteristics for measure currents.

### INPUT/OUTPUT INTERFACE CONDITIONS

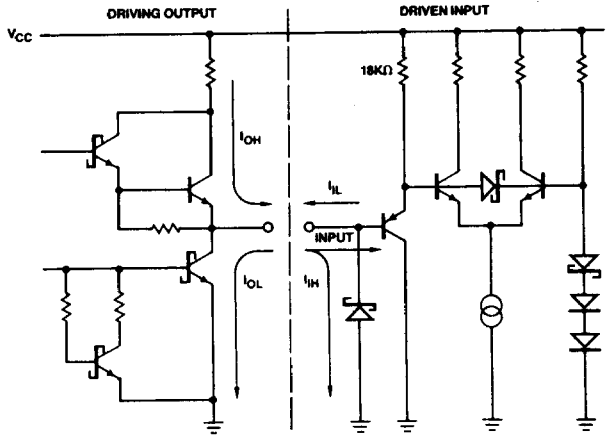

IC000200

Note: Actual current flow direction shown.