



ABSTRACT

The TPS1HC30EVM is a hardware evaluation module (EVM) used to enable hardware engineers to evaluate the full performance and functionality of the TPS1HC30-Q1 automotive high side switch. The TPS1HC30EVM contains everything needed to test and assess the TPS1HC30-Q1 before designing it into part of a greater application power system. The evaluation module is designed to either be used as a standalone board with an attached voltage supply and output load or in conjunction with an underlying Texas Instruments microcontroller by using the standardized BoosterPack™ plug-in module headers. A wide range of application features such as current sensing, programmable current limiting, and transient suppression are enabled and visible through use of this evaluation module.

Table of Contents

1 Introduction.....	2
2 BoosterPack™ Plug-in Module Operation.....	3
3 TPS1HC30EVM Schematic.....	4
4 Connection Descriptions.....	5
5 Current Limit and Current Sense Configuration.....	6
6 Transient Protection.....	7
7 TPS1HC30EVM Assembly Drawings and Layout.....	8
8 Bill Of Materials.....	14
9 Appendix - TPL0102-100 Resistance Codes.....	16

List of Figures

Figure 3-1. TPS1HC30EVM Schematic.....	4
Figure 7-1. Top Layer.....	8
Figure 7-2. Power Layer.....	9
Figure 7-3. Ground Layer.....	10
Figure 7-4. Bottom Layer.....	11
Figure 7-5. 3D View - Top.....	12
Figure 7-6. 3D View - Bottom.....	13

List of Tables

Table 2-1. BoosterPack™ Plug-in Module Pin Assignment.....	3
Table 4-1. Connections and Test Points.....	5
Table 4-2. Jumper Configurations.....	5

Trademarks

BoosterPack™ and LaunchPad™ are trademarks of Texas Instruments.
All trademarks are the property of their respective owners.

1 Introduction

CAUTION		
	Caution	Caution Hot surface. Contact may cause burns. Do not touch!

The Texas Instruments TPS1HC30EVM is an evaluation module that is used to demonstrate and showcase all of the features of the underlying TPS1HC30-Q1 automotive high side switch. This evaluation board provides a seamless way to connect a power supply to the input of the TPS1HC30-Q1, connect a load to the output channel, and switch on and off the device using the control pins of the chip itself. An onboard 3.3-V LDO is included on the EVM to simplify controlling signals to the TPS1HC30-Q1 and easily assert and deassert logic signals by the use of a set of external hardware jumpers. Additionally, this EVM includes BoosterPack plug-in module headers allowing the user to easily connect the TPS1HC30-Q1 high side switch to an underlying microcontroller and write software to control and configure the device.

Features of the TPS1HC30EVM include:

- Standalone operation with standard bench equipment or easy pairing with external microcontroller through BoosterPack plug-in module headers
- Onboard TPL0102-100 digital potentiometer to allow for a programmable current limit through I2C
- Potentiometer for SNS and ILIM resistors, allowing for easy configuration of external resistance values
- Onboard 3.3-V LDO, allowing for control signals to be manipulated by set of jumpers
- Four-layer 2-oz board layout and copper area for thermal performance
- Optional footprints for input TVS diodes to extend transient protection of the device

2 BoosterPack™ Plug-in Module Operation

While the TPS1HC30EVM can be used as a standalone evaluation board without the need of any external microcontroller, the EVM also comes populated with BoosterPack plug-in module headers to enable easy interface with a Texas Instruments microcontroller. The 40-pin headers of the BoosterPack plug-in module headers are used, however all signals can be accessed using headers J1 and J2 enabling use with the 20-pin header. Additionally, by populating the "LDO to BP Power" jumper, the user has the ability to power the underlying LaunchPad™ development kit through the integrated 3.3-V LDO on the TPS1HC30EVM. The following table contains a list of pins connected to the BoosterPack plug-in module header.

Table 2-1. BoosterPack™ Plug-in Module Pin Assignment

BoosterPack Plug-in Module Pin	Function	Note
J1-1	3.3-V power rail	Disconnect "LDO to BP Power" if powering from USB.
J1-5	Open-drain FAULT pin from TPS1HC30-Q1	J13 controls whether the FAULT pin is pulled up from the BoosterPack plug-in module's 3.3-V rail or the 3.3-V onboard LDO of the TPS1HC30EVM.
J1-6	Current sensing through the SNS pin	Resistor controlled either by digital potentiometer U3, potentiometer labeled "SNS" or soldered down resistor R12
J1-9	I2C SDA line for onboard TPL0102-100 digipot (controlling the current limit)	Pulled up to BoosterPack plug-in module's 3.3-V rail
J1-10	I2C SCL line for onboard TPL0102-100 digipot (controlling the current limit)	Pulled up to BoosterPack plug-in module's 3.3-V rail
J2-5	EN to enable VOUT	Active high. Can be connected to PWM.
J2-6	LATCH pin of TPS1HC30-Q1	Controls latching behavior of the TPS1HC30-Q1. See the device data sheet for details.
J2-7	DIAG_EN pin of TPS1HC30-Q1	Enables and disables diagnostics for the TPS1HC30-Q1. See the device data sheet for details.

3 TPS1HC30EVM Schematic

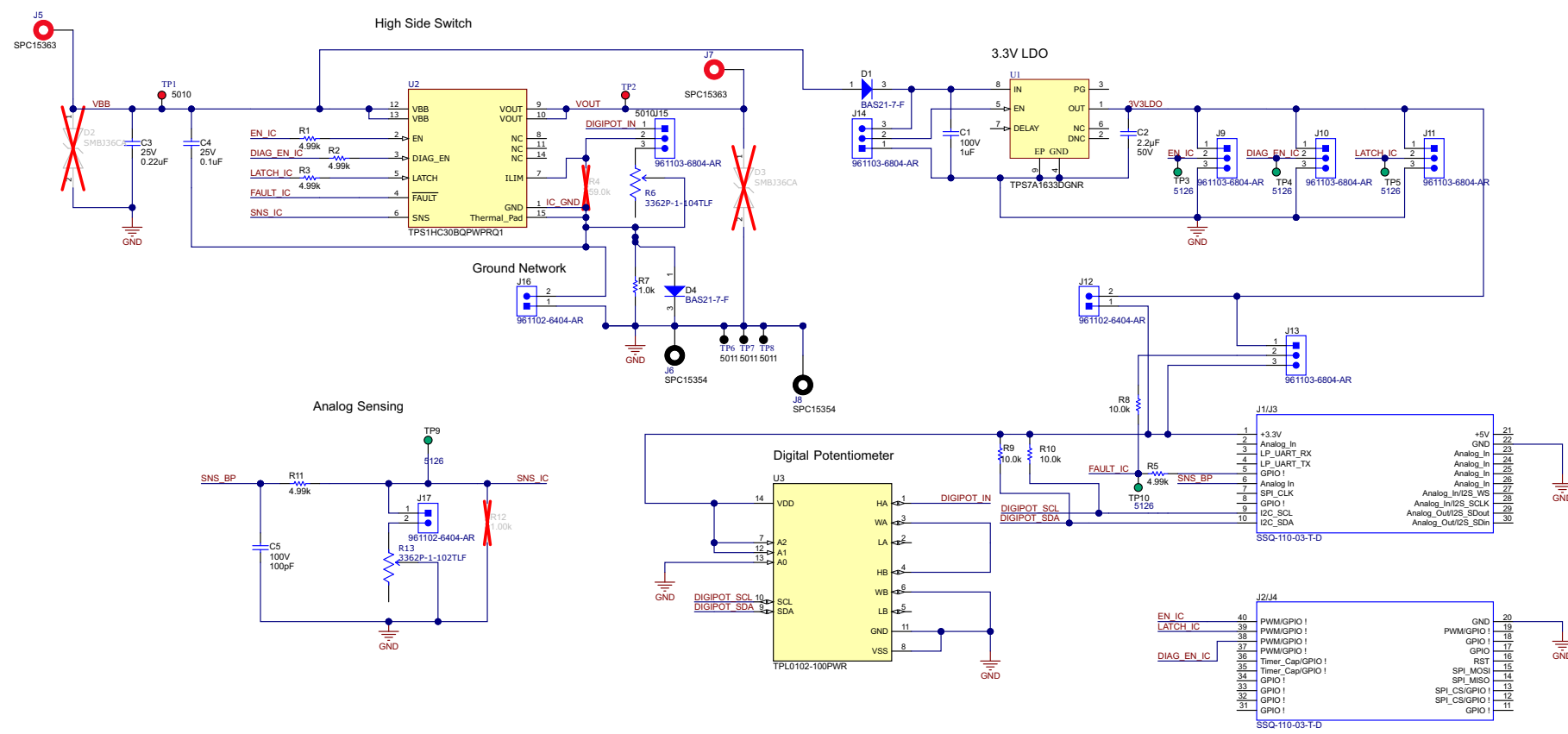

Figure 3-1. TPS1HC30EVM Schematic

4 Connection Descriptions

Most connectors and test points are labeled with their functional names on the silk screen of the PCB and the actual component names are omitted to avoid clutter on the silk screen of the EVM. Likewise, jumpers are labeled to be self explanatory. The following tables contain a description of each test point and its purpose.

Note that by default the TPS1HC30EVM comes configured for standalone operation with no attached LaunchPad development kit.

Table 4-1. Connections and Test Points

Connector or Test Point	Description
J5, VBB test points	VBB input (supply)
J7, VOUT test points	VOUT output (from device)
J6, J8, GND test points	Ground connection (system ground)
DIAG_EN	Enable and disable diagnostics on the TPS1HC30-Q1
EN	Enable line for the TPS1HC30-Q1
LATCH	Controls latch functionality for the TPS1HC30-Q1
SNS	Current sense test point for the current sense output of the TPS1HC30-Q1
FAULT	Open-drain fault test point for the TPS1HC30-Q1. Pullup source can be configured using J13.

Table 4-2. Jumper Configurations

Jumper	Function, Setting
Current limit setting	POT enables the physical "Current Limit" potentiometer, DIGI POT enables the digital potentiometer U3 (TPL0102-100), not populating the jumper defaults to the solder down resistor pad, R4.
SNS pot enable	Enables the physical "SNS" potentiometer connected to the current sense output of the TPS1HC30-Q1. Not populating this jumper defaults to the solder down resistor, R12.
LDO_EN / LDO_DIS	Enables and disables the onboard 3.3-V LDO
J13 (fault pullup)	Configures where the fault pin is pulled up from. This jumper is either from the 3.3-V LDO or the 3.3-V rail from the attached LaunchPad development kit.
LDO to BP power	Connects the output of the onboard 3.3-V LDO to the 3.3-V rail of the attached BoosterPack plug-in module. This jumper is used to power the attached LaunchPad development kit using the LDO of the TPS1HC30EVM.
DIAG_EN	Connects the TPS1HC30-Q1's DIAG_EN signal to either the LDO's 3.3-V signal or ground
EN	Connects the TPS1HC30-Q1's EN signal to either the LDO's 3.3-V signal or ground
LATCH	Connects the TPS1HC30-Q1's LATCH signal to either the LDO's 3.3-V signal or ground
GND net bypass	Bypasses the resistor and diode ground network and connects IC ground to system ground

5 Current Limit and Current Sense Configuration

The current limit resistor connected to the ILIM pin configures the current limit of the TPS1HC30-Q1 device. Based off the limit of this resistor, the allowed current that passes through the high side switch can be controlled. The TPS1HC30EVM provides three different ways of configuring the effective value of the resistance on the ILIM pin:

- With a physical potentiometer labeled "Current Limit"
- Using a soldered down resistor, *R6*
- Through I2C using an onboard digital potentiometer, *U2* (TPL0102-100)

See the [Table 4-2](#) section for details on how to configure each one of these jumpers.

For the digital potentiometer option, the user has the ability to control the current limit via the TPL0102-100 digital potentiometer with I2C. The SDA and SCL lines of the digital potentiometer are connected to the standardized *J1-9* and *J1-10* pins of the BoosterPack plug-in module header. Both pins are pulled up with pullup resistors connected to the LaunchPad development kit 3.3-V power rail. For more details on how to program the TPL0102-100 device, refer to the [TPL0102 Two 256-Taps Digital Potentiometers With Non-Volatile Memory data sheet](#).

In the TPS1HC30EVM, both channels of the digital potentiometer are connected in series with each other, allowing for a greater resolution of configurable current limit value. The target address of the TPL0102-100 is configured to be *0x56*. To configure the current limit, a simple 3-byte I2C write transaction must be performed to set the configured resistance value. The first byte must be *0x00* (corresponding to the resistance value register) and the next two bytes must be the corresponding resistance codes from the table in [Appendix - TPL0102-100 Resistance Codes](#). These two values add up in series to make up the total resistance connected to the ILIM pin of the TPS1HC30-Q1. After the STOP condition is written through the I2C line, the configured resistance value takes effect on the TPL0102-100.

For the current sense resistance connected to the SNS pin, the "SNS Pot Enable" jumper controls the source. If this jumper is populated, the "SNS" potentiometer is used to increase and decrease the resistance connected to the SNS pin. If this jumper is not populated, the solder down pad, *R13*, must be used to provide the necessary resistance value. The output of the TPS1HC30-Q1's SNS pin is an analog current that is a representation of the load current going through the switch. The purpose of the sense resistor is to convert this current into a voltage so that an ADC can convert it into a value for a microcontroller to use. For the TPS1HC30EVM, the voltage across the sense resistor can either be read externally through the SNS test point or from the BoosterPack plug-in module standardized analog *J1-6* pin.

6 Transient Protection

The TPS1HC30EVM provides several footprints and populated components used to mitigate transient power events such as ESD, surges, and inductive load turn-offs. These protection mechanisms are provided in addition to the integrated transient mitigation features of the TPS1HC30-Q1. Refer to the TPS1HC30-Q1 data sheet for more information about the internal protections that the device provides.

The TPS1HC30EVM provides the following transient protection features:

- Input TVS diode on VS (D2) to protect against upstream power events (not populated)
- Optional external inductive load turn-off diode footprints on D3 to provide a mechanism to discharge an inductive load if the internal clamp is not adequate (not populated)

7 TPS1HC30EVM Assembly Drawings and Layout

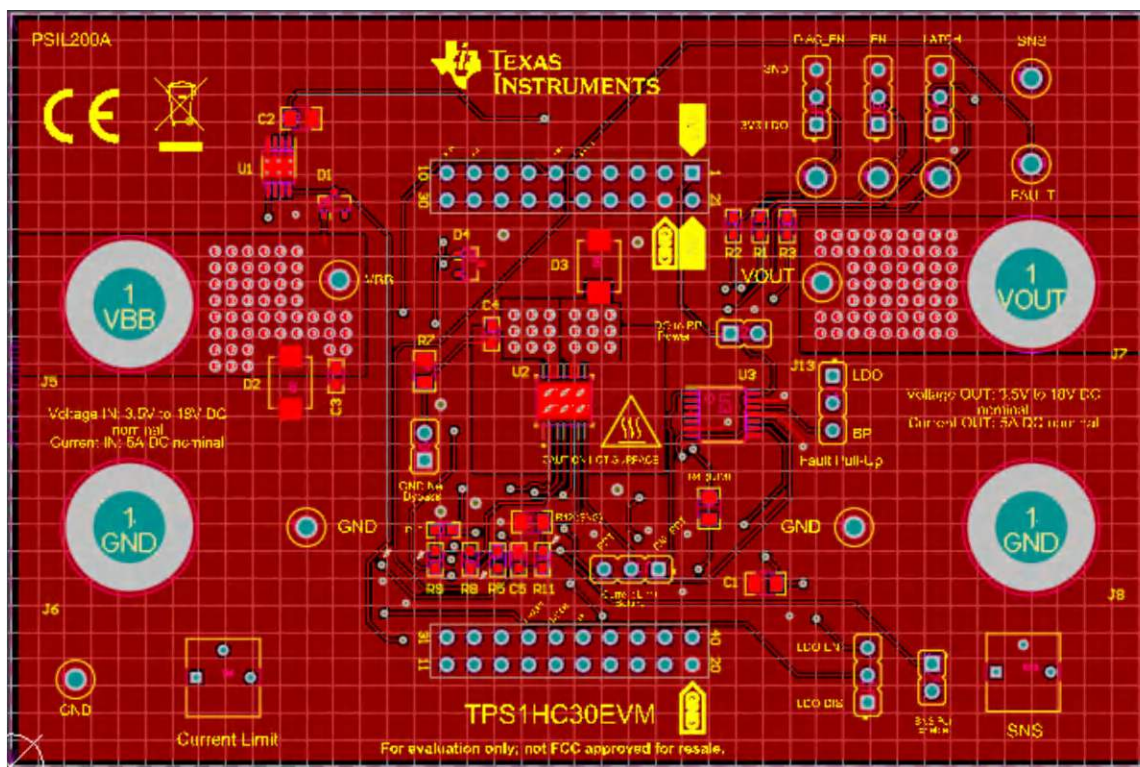

Figure 7-1. Top Layer

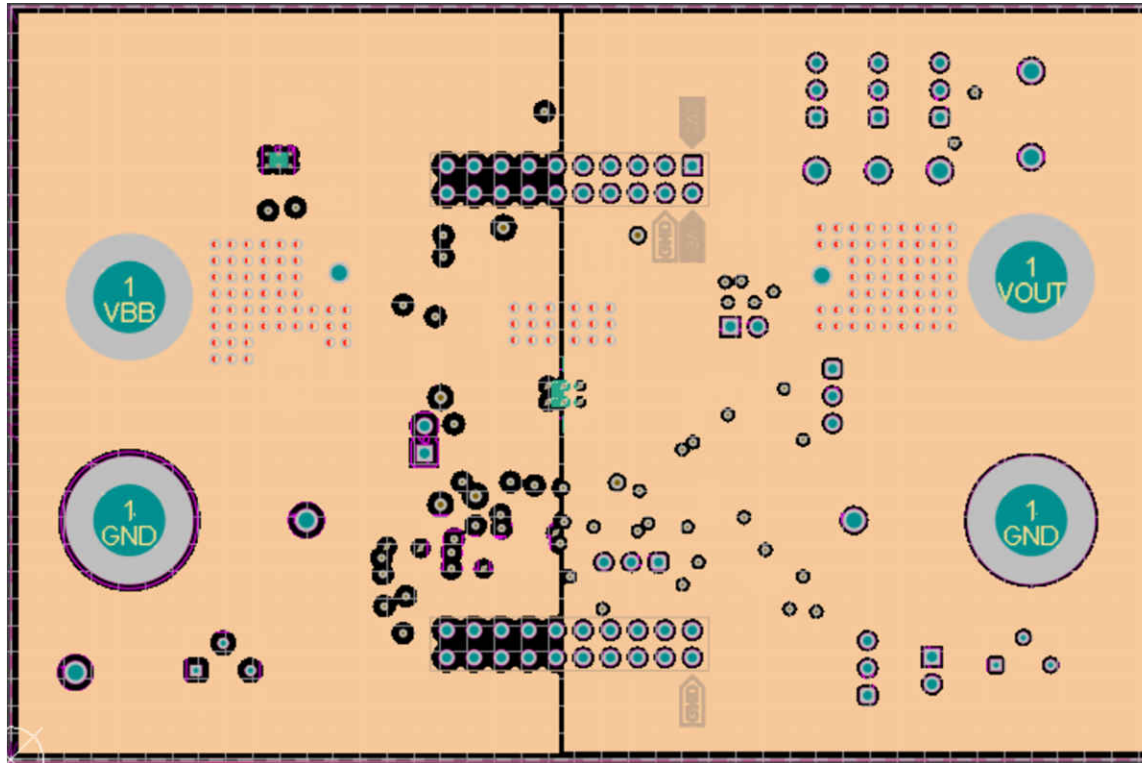

Figure 7-2. Power Layer

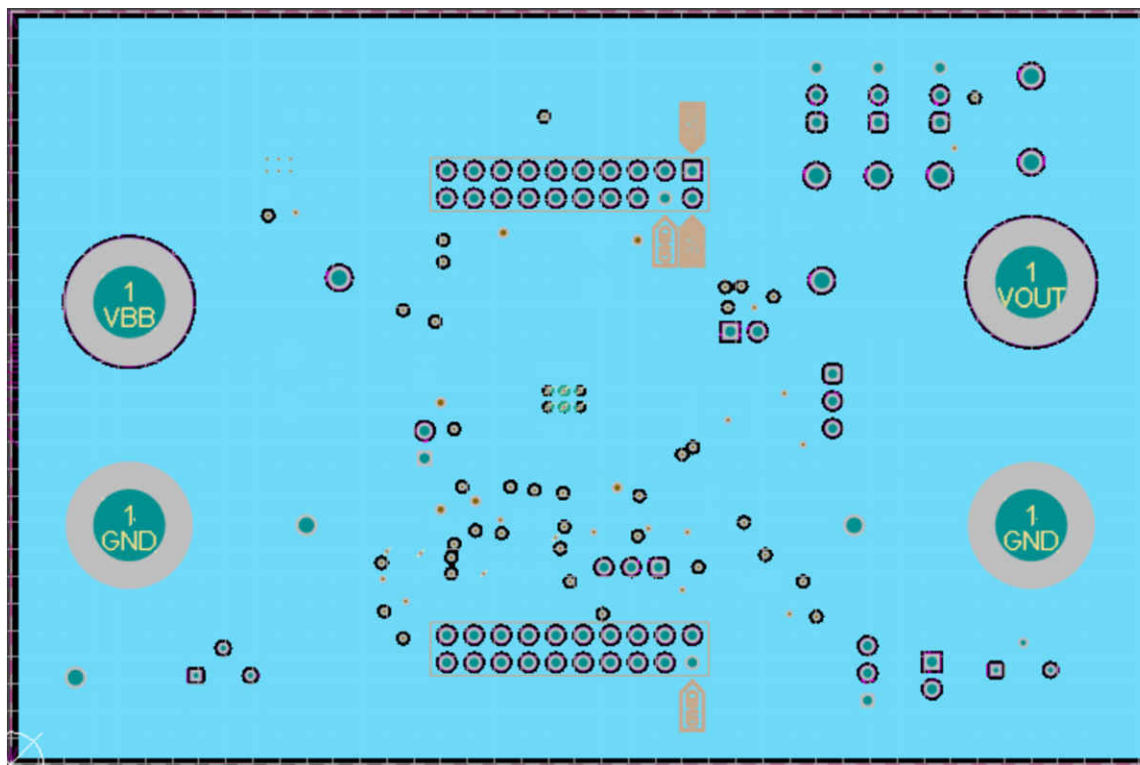

Figure 7-3. Ground Layer

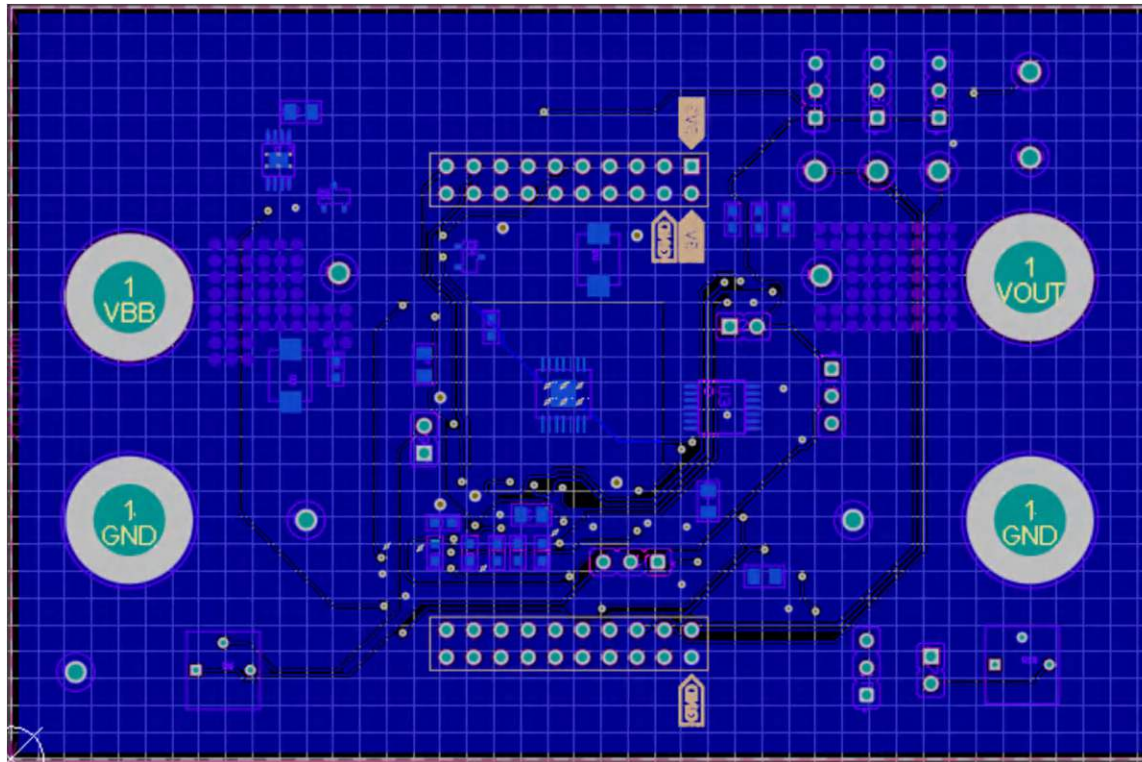

Figure 7-4. Bottom Layer

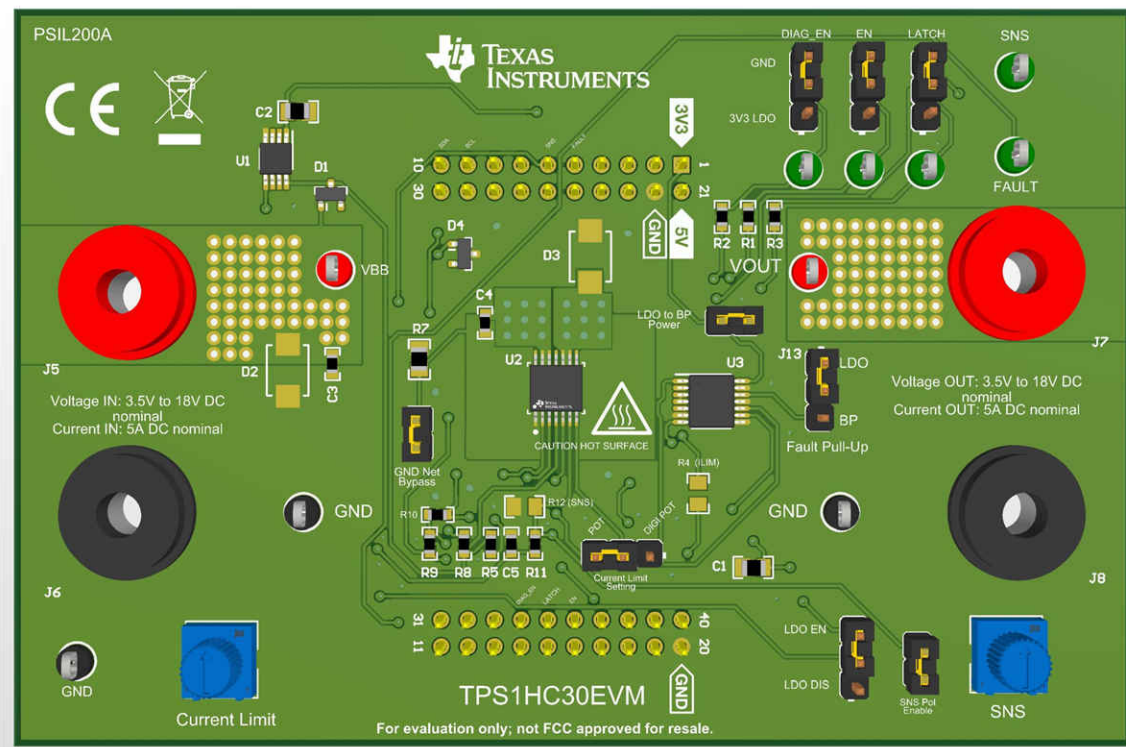

Figure 7-5. 3D View - Top

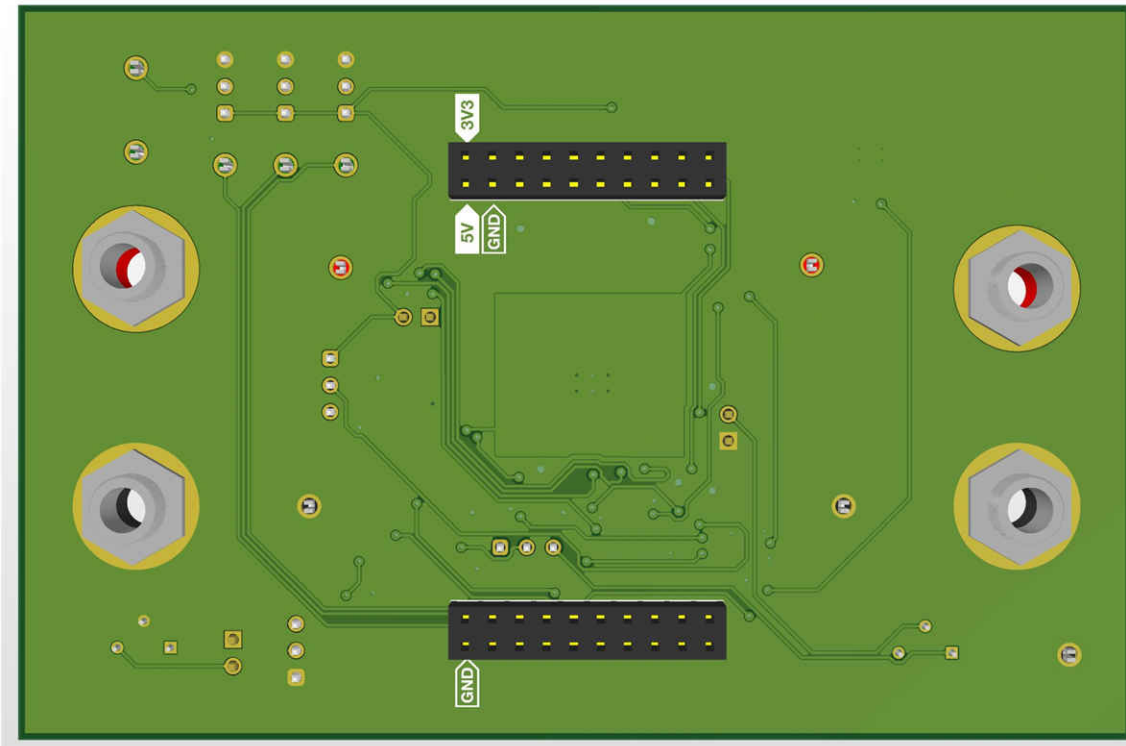

Figure 7-6. 3D View - Bottom

8 Bill Of Materials

Designator	Quantity	Value	Description	Package Reference	Part Number	Manufacturer
C1	1	1 uF	CAP, CERM, 1 uF, 100 V, +/- 10%, X7S, AEC-Q200 Grade 1, 0805	805	CGA4J3X7S2A105K125AB	TDK
C2	1	2.2 uF	CAP, CERM, 2.2 uF, 50 V, +/- 10%, X7R, AEC-Q200 Grade 1, 0805	805	CGA4J3X7R1H225K125AB	TDK
C3	1	0.22 uF	CAP, CERM, 0.22 uF, 25 V, +/- 10%, X8R, AEC-Q200 Grade 0, 0603	603	CGA3E3X8R1E224K080AB	TDK
C4	1	0.1 uF	CAP, CERM, 0.1 uF, 25 V, +/- 10%, X8R, AEC-Q200 Grade 0, 0603	603	CGA3E2X8R1E104K080AA	TDK
C5	1	100 pF	CAP, CERM, 100 pF, 100 V, +/- 5%, C0G/NP0, AEC-Q200 Grade 1, 0603	603	GCM1885C2A101JA16D	MuRata
D1, D4	2	200 V	Diode, Switching, 200 V, 0.2 A, SOT-23	SOT-23	BAS21-7-F	Diodes Inc.
J1/J3, J2/J4	2		Receptacle, 2.54mm, 10x2, Tin, TH	10x2 Receptacle	SSQ-110-03-T-D	Samtec
J5, J7	2		BANANA JACK, SOLDER LUG, RED, TH	Red Insulated Banana Jack	SPC15363	Tenma
J6, J8	2		BANANA JACK, SOLDER LUG, BLACK, TH	Black Insulated Banana Jack	SPC15354	Tenma
J9, J10, J11, J13, J14, J15	6		Header, 2.54mm, 3x1, Gold, TH	Header, 2.54mm, 3x1, TH	961103-6804-AR	3M
J12, J16, J17	3		Header, 2.54mm, 2x1, TH	Header, 2.54mm, 2x1, TH	961102-6404-AR	3M
R1, R2, R3, R5, R11	5	4.99 k	RES, 4.99 k, 1%, 0.1 W, AEC-Q200 Grade 0, 0603	603	CRCW06034K99FKEA	Vishay-Dale
R6	1	100 kΩ	Res Cermet Trimmer 100K Ohm 10% 1/2W 1(Elec)/1(Mech)Turn 5mm (6.71 X 7.04 X 14.63mm) Pin Thru-Hole Tube	PTH_TRIMMER_6MM60_6MM99	3362P-1-104TLF	Bourns
R7	1	1.0 k	RES, 1.0 k, 5%, 0.125 W, AEC-Q200 Grade 0, 0805	805	ERJ-6GEYJ102V	Panasonic
R8, R9, R10	3	10.0 k	RES, 10.0 k, 0.05%, 0.1 W, AEC-Q200 Grade 0, 0603	603	ERA-3ARW103V	Panasonic
R13	1	1 k	1 kOhms 0.5W, 1/2W PC Pins Through Hole Trimmer Potentiometer Cermet 1 Turn Top Finger Adjustment	PTH_POT_6MM6_6MM99	3362P-1-102TLF	Bourns
SH-J1, SH-J2, SH-J3, SH-J4, SH-J5, SH-J6, SH-J7, SH-J8, SH-J9	9	1x2	Shunt, 100mil, Gold plated, Black	Shunt	SNT-100-BK-G	Samtec
TP1, TP2	2		Test Point, Multipurpose, Red, TH	Red Multipurpose Testpoint	5010	Keystone

Designator	Quality	Value	Description	Package Reference	Part Number	Manufacturer
TP3, TP4, TP5, TP9, TP10	5		Test Point, Multipurpose, Green, TH	Green Multipurpose Testpoint	5126	Keystone
TP6, TP7, TP8	3		Test Point, Multipurpose, Black, TH	Black Multipurpose Testpoint	5011	Keystone
U1	1		Single Output LDO, 100 mA, Fixed 3.3 V Output, 3 to 60 V Input, with Enable and Power Good, 8-pin MSOP (DGN), -40 to 125 degC, Green (RoHS & no Sb/Br)	DGN0008C	TPS7A1633DGNR	Texas Instruments
U2	1		30-mΩ, 5-A Single-Channel Smart High-Side Switch, HTSSOP14	HTSSOP14	TPS1HC30BQPWPRQ1	Texas Instruments
U3	1		256-Taps Dual-Channel Digital Potentiometer With I2C Interface and Nonvolatile Memory, PW0014A (TSSOP-14)	PW0014A	TPL0102-100PWR	Texas Instruments
D2, D3	0		Diode TVS Single Bi-Dir 36V 600W 2-Pin SMB	DO-214AA	SMBJ36CA	Littelfuse
R4	0	59.0 k	RES, 59.0 k, 1%, 0.125 W, AEC-Q200 Grade 0, 0805	805	ERJ-6ENF5902V	Panasonic
R12	0	1.00 k	RES, 1.00 k, 1%, 0.25 W, 0805	805	ERJ-P06F1001V	Panasonic

9 Appendix - TPL0102-100 Resistance Codes

Step	Hex	Binary	Resistance (kΩ)
0 (zero-scale)	0x00h	0000 0000	100.00
1	0x01h	0000 0001	99.61
2	0x02h	0000 0010	99.22
3	0x03h	0000 0011	98.83
4	0x04h	0000 0100	98.44
5	0x05h	0000 0101	98.05
6	0x06h	0000 0110	97.66
7	0x07h	0000 0111	97.27
8	0x08h	0000 1000	96.88
9	0x09h	0000 1001	96.48
10	0x0Ah	0000 1010	96.09
11	0x0Bh	0000 1011	95.70
12	0x0Ch	0000 1100	95.31
13	0x0Dh	0000 1101	94.92
14	0x0Eh	0000 1110	94.53
15	0x0Fh	0000 1111	94.14
16	0x10h	0001 0000	93.75
17	0x11h	0001 0001	93.36
18	0x12h	0001 0010	92.97
19	0x13h	0001 0011	92.58
20	0x14h	0001 0100	92.19
21	0x15h	0001 0101	91.80
22	0x16h	0001 0110	91.41
23	0x17h	0001 0111	91.02
24	0x18h	0001 1000	90.63
25	0x19h	0001 1001	90.23
26	0x1Ah	0001 1010	89.84
27	0x1Bh	0001 1011	89.45
28	0x1Ch	0001 1100	89.06
29	0x1Dh	0001 1101	88.67
30	0x1Eh	0001 1110	88.28
31	0x1Fh	0001 1111	87.89
32	0x20h	0010 0000	87.50
33	0x21h	0010 0001	87.11
34	0x22h	0010 0010	86.72
35	0x23h	0010 0011	86.33
36	0x24h	0010 0100	85.94
37	0x25h	0010 0101	85.55
38	0x26h	0010 0110	85.16
39	0x27h	0010 0111	84.77
40	0x28h	0010 1000	84.38
41	0x29h	0010 1001	83.98
42	0x2Ah	0010 1010	83.59
43	0x2Bh	0010 1011	83.20
44	0x2Ch	0010 1100	82.81
45	0x2Dh	0010 1101	82.42

Step	Hex	Binary	Resistance (kΩ)
46	0x2Eh	0010 1110	82.03
47	0x2Fh	0010 1111	81.64
48	0x30h	0011 0000	81.25
49	0x31h	0011 0001	80.86
50	0x32h	0011 0010	80.47
51	0x33h	0011 0011	80.08
52	0x34h	0011 0100	79.69
53	0x35h	0011 0101	79.30
54	0x36h	0011 0110	78.91
55	0x37h	0011 0111	78.52
56	0x38h	0011 1000	78.13
57	0x39h	0011 1001	77.73
58	0x3Ah	0011 1010	77.34
59	0x3Bh	0011 1011	76.95
60	0x3Ch	0011 1100	76.56
61	0x3Dh	0011 1101	76.17
62	0x3Eh	0011 1110	75.78
63	0x3Fh	0011 1111	75.39
64	0x40h	0100 0000	75.00
65	0x41h	0100 0001	74.61
66	0x42h	0100 0010	74.22
67	0x43h	0100 0011	73.83
68	0x44h	0100 0100	73.44
69	0x45h	0100 0101	73.05
70	0x46h	0100 0110	72.66
71	0x47h	0100 0111	72.27
72	0x48h	0100 1000	71.88
73	0x49h	0100 1001	71.48
74	0x4Ah	0100 1010	71.09
75	0x4Bh	0100 1011	70.70
76	0x4Ch	0100 1100	70.31
77	0x4Dh	0100 1101	69.92
78	0x4Eh	0100 1110	69.53
79	0x4Fh	0100 1111	69.14
80	0x50h	0101 0000	68.75
81	0x51h	0101 0001	68.36
82	0x52h	0101 0010	67.97
83	0x53h	0101 0011	67.58
84	0x54h	0101 0100	67.19
85	0x55h	0101 0101	66.80
86	0x56h	0101 0110	66.41
87	0x57h	0101 0111	66.02
88	0x58h	0101 1000	65.63
89	0x59h	0101 1001	65.23
90	0x5Ah	0101 1010	64.84
91	0x5Bh	0101 1011	64.45
92	0x5Ch	0101 1100	64.06
93	0x5Dh	0101 1101	63.67

Step	Hex	Binary	Resistance (kΩ)
94	0x5Eh	0101 1110	63.28
95	0x5Fh	0101 1111	62.89
96	0x60h	0110 0000	62.50
97	0x61h	0110 0001	62.11
98	0x62h	0110 0010	61.72
99	0x63h	0110 0011	61.33
100	0x64h	0110 0100	60.94
101	0x65h	0110 0101	60.55
102	0x66h	0110 0110	60.16
103	0x67h	0110 0111	59.77
104	0x68h	0110 1000	59.38
105	0x69h	0110 1001	58.98
106	0x6Ah	0110 1010	58.59
107	0x6Bh	0110 1011	58.20
108	0x6Ch	0110 1100	57.81
109	0x6Dh	0110 1101	57.42
110	0x6Eh	0110 1110	57.03
111	0x6Fh	0110 1111	56.64
112	0x70h	0111 0000	56.25
113	0x71h	0111 0001	55.86
114	0x72h	0111 0010	55.47
115	0x73h	0111 0011	55.08
116	0x74h	0111 0100	54.69
117	0x75h	0111 0101	54.30
118	0x76h	0111 0110	53.91
119	0x77h	0111 0111	53.52
120	0x78h	0111 1000	53.13
121	0x79h	0111 1001	52.73
122	0x7Ah	0111 1010	52.34
123	0x7Bh	0111 1011	51.95
124	0x7Ch	0111 1100	51.56
125	0x7Dh	0111 1101	51.17
126	0x7Eh	0111 1110	50.78
127	0x7Fh	0111 1111	50.39
128	0x80h	1000 0000	50.00
129	0x81h	1000 0001	49.61
130	0x82h	1000 0010	49.22
131	0x83h	1000 0011	48.83
132	0x84h	1000 0100	48.44
133	0x85h	1000 0101	48.05
134	0x86h	1000 0110	47.66
135	0x87h	1000 0111	47.27
136	0x88h	1000 1000	46.88
137	0x89h	1000 1001	46.48
138	0x8Ah	1000 1010	46.09
139	0x8Bh	1000 1011	45.70
140	0x8Ch	1000 1100	45.31
141	0x8Dh	1000 1101	44.92

Step	Hex	Binary	Resistance (kΩ)
142	0x8Eh	1000 1110	44.53
143	0x8Fh	1000 1111	44.14
144	0x90h	1001 0000	43.75
145	0x91h	1001 0001	43.36
146	0x92h	1001 0010	42.97
147	0x93h	1001 0011	42.58
148	0x94h	1001 0100	42.19
149	0x95h	1001 0101	41.80
150	0x96h	1001 0110	41.41
151	0x97h	1001 0111	41.02
152	0x98h	1001 1000	40.63
153	0x99h	1001 1001	40.23
154	0x9Ah	1001 1010	39.84
155	0x9Bh	1001 1011	39.45
156	0x9Ch	1001 1100	39.06
157	0x9Dh	1001 1101	38.67
158	0x9Eh	1001 1110	38.28
159	0x9Fh	1001 1111	37.89
160	0xA0h	1010 0000	37.50
161	0xA1h	1010 0001	37.11
162	0xA2h	1010 0010	36.72
163	0xA3h	1010 0011	36.33
164	0xA4h	1010 0100	35.94
165	0xA5h	1010 0101	35.55
166	0xA6h	1010 0110	35.16
167	0xA7h	1010 0111	34.77
168	0xA8h	1010 1000	34.38
169	0xA9h	1010 1001	33.98
170	0xAAh	1010 1010	33.59
171	0xABh	1010 1011	33.20
172	0xACh	1010 1100	32.81
173	0xADh	1010 1101	32.42
174	0xAEh	1010 1110	32.03
175	0xAFh	1010 1111	31.64
176	0xB0h	1011 0000	31.25
177	0xB1h	1011 0001	30.86
178	0xB2h	1011 0010	30.47
179	0xB3h	1011 0011	30.08
180	0xB4h	1011 0100	29.69
181	0xB5h	1011 0101	29.30
182	0xB6h	1011 0110	28.91
183	0xB7h	1011 0111	28.52
184	0xB8h	1011 1000	28.13
185	0xB9h	1011 1001	27.73
186	0xBAh	1011 1010	27.34
187	0xBBh	1011 1011	26.95
188	0xBCh	1011 1100	26.56
189	0xBDh	1011 1101	26.17

Step	Hex	Binary	Resistance (kΩ)
190	0xBEh	1011 1110	25.78
191	0xBFh	1011 1111	25.39
192	0xC0h	1100 0000	25.00
193	0xC1h	1100 0001	24.61
194	0xC2h	1100 0010	24.22
195	0xC3h	1100 0011	23.83
196	0xC4h	1100 0100	23.44
197	0xC5h	1100 0101	23.05
198	0xC6h	1100 0110	22.66
199	0xC7h	1100 0111	22.27
200	0xC8h	1100 1000	21.88
201	0xC9h	1100 1001	21.48
202	0xCAh	1100 1010	21.09
203	0xCBh	1100 1011	20.70
204	0xCCh	1100 1100	20.31
205	0xCDh	1100 1101	19.92
206	0xCEh	1100 1110	19.53
207	0xCFh	1100 1111	19.14
208	0xD0h	1101 0000	18.75
209	0xD1h	1101 0001	18.36
210	0xD2h	1101 0010	17.97
211	0xD3h	1101 0011	17.58
212	0xD4h	1101 0100	17.19
213	0xD5h	1101 0101	16.80
214	0xD6h	1101 0110	16.41
215	0xD7h	1101 0111	16.02
216	0xD8h	1101 1000	15.63
217	0xD9h	1101 1001	15.23
218	0xDAh	1101 1010	14.84
219	0xDBh	1101 1011	14.45
220	0xDCh	1101 1100	14.06
221	0xDDh	1101 1101	13.67
222	0xDEh	1101 1110	13.28
223	0xDFh	1101 1111	12.89
224	0xE0h	1110 0000	12.50
225	0xE1h	1110 0001	12.11
226	0xE2h	1110 0010	11.72
227	0xE3h	1110 0011	11.33
228	0xE4h	1110 0100	10.94
229	0xE5h	1110 0101	10.55
230	0xE6h	1110 0110	10.16
231	0xE7h	1110 0111	9.77
232	0xE8h	1110 1000	9.38
233	0xE9h	1110 1001	8.98
234	0xEAh	1110 1010	8.59
235	0xEBh	1110 1011	8.20
236	0xECh	1110 1100	7.81
237	0xEDh	1110 1101	7.42

Step	Hex	Binary	Resistance (kΩ)
238	0xEEh	1110 1110	7.03
239	0xEFh	1110 1111	6.64
240	0xF0h	1111 0000	6.25
241	0xF1h	1111 0001	5.86
242	0xF2h	1111 0010	5.47
243	0xF3h	1111 0011	5.08
244	0xF4h	1111 0100	4.69
245	0xF5h	1111 0101	4.30
246	0xF6h	1111 0110	3.91
247	0xF7h	1111 0111	3.52
248	0xF8h	1111 1000	3.13
249	0xF9h	1111 1001	2.73
250	0xFAh	1111 1010	2.34
251	0xFBh	1111 1011	1.95
252	0xFC	1111 1100	1.56
253	0xFDh	1111 1101	1.17
254	0xFEh	1111 1110	0.78
255 (full-scale)	0xFFh	1111 1111	0.3

IMPORTANT NOTICE AND DISCLAIMER

TI PROVIDES TECHNICAL AND RELIABILITY DATA (INCLUDING DATA SHEETS), DESIGN RESOURCES (INCLUDING REFERENCE DESIGNS), APPLICATION OR OTHER DESIGN ADVICE, WEB TOOLS, SAFETY INFORMATION, AND OTHER RESOURCES "AS IS" AND WITH ALL FAULTS, AND DISCLAIMS ALL WARRANTIES, EXPRESS AND IMPLIED, INCLUDING WITHOUT LIMITATION ANY IMPLIED WARRANTIES OF MERCHANTABILITY, FITNESS FOR A PARTICULAR PURPOSE OR NON-INFRINGEMENT OF THIRD PARTY INTELLECTUAL PROPERTY RIGHTS.

These resources are intended for skilled developers designing with TI products. You are solely responsible for (1) selecting the appropriate TI products for your application, (2) designing, validating and testing your application, and (3) ensuring your application meets applicable standards, and any other safety, security, regulatory or other requirements.

These resources are subject to change without notice. TI grants you permission to use these resources only for development of an application that uses the TI products described in the resource. Other reproduction and display of these resources is prohibited. No license is granted to any other TI intellectual property right or to any third party intellectual property right. TI disclaims responsibility for, and you will fully indemnify TI and its representatives against, any claims, damages, costs, losses, and liabilities arising out of your use of these resources.

TI's products are provided subject to [TI's Terms of Sale](#) or other applicable terms available either on ti.com or provided in conjunction with such TI products. TI's provision of these resources does not expand or otherwise alter TI's applicable warranties or warranty disclaimers for TI products.

TI objects to and rejects any additional or different terms you may have proposed.

Mailing Address: Texas Instruments, Post Office Box 655303, Dallas, Texas 75265
Copyright © 2022, Texas Instruments Incorporated