



## MAX1002/MAX1003 Evaluation Kits

### General Description

The MAX1002/MAX1003 evaluation kits (EV kits) simplify evaluation of the 60Msps MAX1002 and 90Msps MAX1003 dual, 6-bit analog-to-digital converters (ADCs). The kits include the basic components necessary to operate the on-chip oscillator as a voltage-controlled oscillator (VCO). Each board can also be easily modified to accommodate an external clocking source.

Connectors for power supplies, analog inputs, and digital outputs simplify connections to the device. The PC board features an optimized layout to ensure the best possible dynamic performance. The EV kits include a MAX1002 or MAX1003.

### Component List

DESIGNATION	QTY	DESCRIPTION
C1, C10, C11, C12	4	0.01 $\mu$ F, 25V min, 10% ceramic capacitors
C2, C3, C6, C7	4	47pF, 25V min, 5% ceramic capacitors
C4, C15	2	0.22 $\mu$ F, 25V min, 10% ceramic capacitors
C5	1	5pF, 10V min, 10% ceramic capacitor (MAX1003)
		22pF, 10V min, 10% ceramic capacitor (MAX1002)
C8, C9, C13, C14	4	0.1 $\mu$ F, 10V min, 10% ceramic capacitors
C16, C17	2	10 $\mu$ F, 10V min, 20% tantalum caps AVX TAJC106K016
R1	1	10k $\Omega$ , 5% resistor
R2, R3	2	47k $\Omega$ , 5% resistors
R4-R7	4	49.9 $\Omega$ , 1% resistors
L1	1	220nH inductor Coilcraft 1008CS-221TKBC
U1	1	MAX1003CAX, 90Msps
		MAX1002CAX, 60Msps
D1	1	Varactor diode M/A-COM MA4ST079CK-287, SOT23
IIN+, IIN-, QIN+, QIN-	4	BNC connectors
None	1	MAX1002/MAX1003 circuit board
JU1, JU2, JU6, JU7	4	0 $\Omega$ resistors
JU3, JU4, JU8, JU9	4	2-pin headers
JU5	1	3-pin header
JU11	1	2-pin header (MAX1002 only)
J1	1	26-pin connector
None	1	Shunt for JU5

### Features

- ◆ 5.85 Effective Number of Bits at 20MHz Analog Input Frequency
- ◆ Separate Analog and Digital Power and Ground Connections with Optimized PC Board Layout
- ◆ Matched Single-Ended or Differential Analog Inputs for Both I and Q Channels
- ◆ Square-Pin Header for Easy Connection of Logic Analyzer to Digital Outputs
- ◆ User-Selectable ADC Full-Scale Gain Ranges
- ◆ Fully Assembled and Tested

### Ordering Information

PART	TEMP. RANGE	BOARD TYPE
MAX1002EVKIT-SO	0°C to +70°C	Surface Mount
MAX1003EVKIT-SO	0°C to +70°C	Surface Mount

### Component Suppliers

SUPPLIER*	PHONE	FAX
AVX	(803) 946-0690	(803) 626-3123
Coilcraft	(847) 639-6400	(847) 639-1469
M/A-COM	(617) 564-3100	(617) 564-3050
Sprague	(603) 224-1961	(603) 224-1430

\* Please indicate that you are using the MAX1002/MAX1003 when contacting these component suppliers.

### Quick Start

The MAX1002/MAX1003 EV kits are fully assembled and tested. Follow these steps to verify proper board operation. **Do not turn on the power supplies until all connections to the EV kit are completed.**

- 1) Connect a +5V power supply to the pad marked VCC. Connect this supply's ground to the pad marked GND.
- 2) Connect a +3.3V (MAX1003) or +5V (MAX1002) power supply to the pad labeled VCCO. Connect the supply ground to the pad marked OGNB.
- 3) Connect a +4V power supply to the pad marked VTUNE. Connect the supply ground to the GND pad.
- 4) Remove the shunt from jumper JU5. This sets a 250mVp-p full-scale range.

# MAX1002/MAX1003 Evaluation Kits

- 5) Using an RF power splitter-combiner, connect a 250mVp-p, 20MHz sine-wave source to both analog inputs at BNC J3 and J6. The analog input impedance is 50Ω for each channel.
- 6) Connect a logic analyzer to connector J1 to monitor the digital outputs.
- 7) Turn on all power supplies and signal sources.
- 8) Observe the digitized analog input signals with the logic analyzer.

## Detailed Description

### EV Kit Jumpers

The MAX1002/MAX1003 EV kits contain several jumpers that control board and part options. The following sections describe the different jumpers and their purposes. Table 1 lists the jumpers on the EV kits and their default positions.

**Table 1. EV Kit Jumpers and Default Positions**

JUMPER(S)	FUNCTION	DEFAULT POSITION
JU1, JU2, JU6, JU7	Power-supply current-sense ports	Shorted with 0Ω resistors
JU3, JU4, JU8, JU9	Offset-correction amplifier enabled	Open
JU5	ADC full-scale range selection	Open
JU11	VCCO tied to VCC for single-supply operation (MAX1002)	Open

### Power Requirements

Both the MAX1002 and the MAX1003 require +5V at about 65mA for their analog V<sub>CC</sub> supply. Power-supply requirements for the digital outputs, however, are different for the two devices. 0Ω resistors are installed at jumper sites JU1, JU2, JU6, and JU7, and can be removed to sense device power-supply currents with an ammeter.

### MAX1003 Digital Outputs Supply

The MAX1003 requires +3.3V for the V<sub>CCO</sub> supply. The current requirement from the power supply is a function of the sampling clock and analog input frequencies, as well as the capacitive loading on the digital outputs. With 15pF loads and a 20MHz analog input frequency sampled at 90Msps, the current draw is about 10mA.

### MAX1002 Digital Outputs Supply

The MAX1002 uses +5V for its V<sub>CCO</sub> supply. As with the MAX1003, the current requirement is a function of the analog input frequency and capacitive loading on the outputs. With 15pF loads and a 20MHz analog input sampling at 60Msps, the current requirement is about 13mA. You can also use a single power supply for both the V<sub>CC</sub> and V<sub>CCO</sub> supplies by installing jumper JU11, located near the EV kit power-supply connectors. However, for best dynamic performance, use separate analog and digital power supplies.

### Analog Inputs



The analog inputs to the dual ADCs are provided through BNC connectors IIN+, IIN-, QIN+, and QIN-. The connectors are terminated with 49.9Ω to ground and are AC coupled to the converter's analog inputs, which are internally self-biased at 2.35V DC. A typical application circuit drives the IIN+ and QIN+ noninverting analog inputs using AC-coupled in-phase and quadrature signals. The nominal 20kΩ input resistance of the analog inputs, plus the 0.1μF AC-coupling capacitor value, sets the low-frequency corner at about 80Hz.

You can drive the analog inputs either single-ended or differentially using AC- or DC-coupled inputs. Either the inverting or the noninverting input can be driven single-ended. If the inverting input is driven, then the digital output codes are inverted (complemented). Refer to the MAX1002 or MAX1003 data sheet for typical circuits.

### ADC Gain Selection

The single GAIN-select pin on the MAX1002 or MAX1003 controls the full-scale input range for both the I and the Q channels. Jumper JU5 is used to manually select the desired gain range as shown in Table 2. The EV kits are shipped with the mid-gain range selected (jumper pins open).

**Table 2. Gain-Selection Jumper JU5 Settings**

JU5 SETTING	CONNECTION	ADC GAIN RANGE
	Pins 1 and 2 shorted	Low-gain, 500mVp-p
	No pins shorted	Mid-gain, 250mVp-p
	Pins 2 and 3 shorted	High-gain, 125mVp-p

# MAX1002/MAX1003 Evaluation Kits

Evaluate: MAX1002/MAX1003

Table 3 lists the possible input-drive combinations for the mid-gain (250mVp-p) full-scale range selection. Drive levels are referenced to the open-circuit, common-mode voltage of the analog inputs (typically 2.35V) if DC coupled, or to ground if AC coupling is used. If the low-gain (500mVp-p) range is selected, the input-drive requirements are twice those listed in Table 3. If the high-gain (125mVp-p) range is selected, the input-drive requirements are half those listed in Table 3.

**Table 3. Typical Input-Drive Requirements for Mid-Gain**

INPUT DRIVE	QIN+ or IIN+	QIN- or IIN-	OUTPUT CODE
Single-Ended Noninverting	+125mV	Open Circuit	111111
	0	Open Circuit	100000
	-125mV	Open Circuit	000000
Single-Ended Inverting	Open Circuit	+125mV	000000
	Open Circuit	0	011111
	Open Circuit	-125mV	111111
Differential	+62.5mV	-62.5mV	111111
	0	0	100000
	-62.5mV	+62.5mV	000000

### Offset-Correction Amplifiers

The offset-correction amplifiers included on the MAX1002 and MAX1003 are usually enabled in a typical AC-coupled application circuit. For DC-coupled applications, the amplifiers must be disabled by installing shorting blocks on jumpers JU3, JU4 (I channel); and JU8, JU9 (Q channel). These jumpers short device pins IOCC+ (pin 2), IOCC- (pin 3), QOCC- (pin 16), and QOCC+ (pin 17) to ground and disable the amplifiers. The MAX1002/MAX1003 EV kits are configured with the offset-correction amplifiers enabled (jumpers open) and AC-coupled analog inputs.

### Voltage-Controlled-Oscillator Operation

The EV kits include a voltage-controlled-oscillator (VCO) circuit to set the analog-to-digital converter (ADC) sampling rate using an external resonant tank and a varactor diode. A voltage applied to the VTUNE pad changes the varactor diode's capacitance to adjust the tank's resonant frequency, which sets the oscillator's sampling frequency. VTUNE voltage can be varied from 0V to a maximum of 8V.

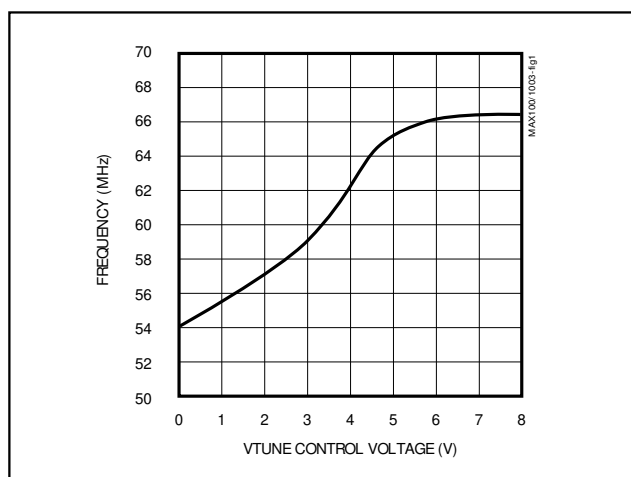

Figure 1. MAX1002 Oscillator Frequency vs. VTUNE Control Voltage

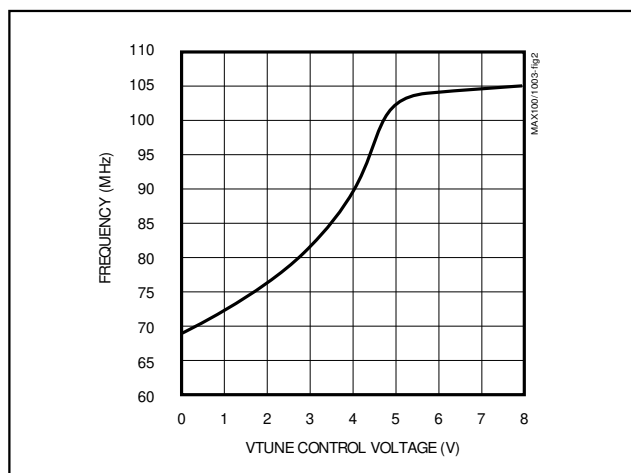

Figure 2. MAX1003 Oscillator Frequency vs. VTUNE Control Voltage

The EV kits are designed so that a nominal VTUNE control voltage of about 4V sets the ADC sampling rate to either 60Msps for the MAX1002 or 90Msps for the MAX1003. The VTUNE control voltage should be well filtered, as any noise on the supply contributes to jitter in the internal oscillator and degrades the converters' dynamic performance. Figures 1 and 2 show the VTUNE control-voltage typical frequency-adjustment ranges for the MAX1002 and MAX1003 EV kits, respectively.

# MAX1002/MAX1003 Evaluation Kits

**Table 4. External Clock Source EV Kit Modifications**

COMPONENT	DESCRIPTION	MODIFICATION
Clock Overdrive	Clock input BNC connector	Add
C5	5pF capacitor (MAX1003), 22pF capacitor (MAX1002)	Remove
C6, C7	47pF capacitors	Replace with 0.01 $\mu$ F capaci- tors
L1	220nH inductor	Remove
R1	10k $\Omega$ resistor	Remove
R2, R3	47k $\Omega$ resistors	Replace with 49.9 $\Omega$ resistors
D1	Varactor diode	Remove

### External Clock Operation

The MAX1002/MAX1003 EV kits can be converted to drive the ADCs from an external clock source. This involves removing the external resonator components from the VCO circuit and adding a few new components. Table 4 lists the EV kit changes required to convert the board to accept an external clock source. The resulting schematic is shown in Figure 4.

The new 49.9 $\Omega$  value of R3 shown in Figure 4 provides proper termination for a 50 $\Omega$  external signal generator. AC-coupling capacitor C6 couples the external clock signal to the MAX1002/MAX1003 oscillator circuitry at TNK+ (pin 9). R2 and C7 ensure that the impedance at both ports of the oscillator is balanced. After all modifications are complete, connect an external clock source to the BNC connector on the EV kit marked CLOCK OVERDRIVE. The recommended clock amplitude is 1Vp-p; however, the ADC operates correctly with as little as 100mVp-p or up to 2.5Vp-p on CLOCK OVERDRIVE.

The external clock source should have low phase noise for best dynamic performance. A low-phase-noise sine-wave oscillator serves this purpose well. A square-wave clock source is not necessary to drive the MAX1002/MAX1003. The devices contain sufficient gain to amplify even a low-level-input sine wave to drive the ADC comparators, while ensuring excellent dynamic performance.

### Digital Outputs

The TTL/CMOS-compatible digital outputs are presented in parallel from both I and Q channels at connector J1. The data format is offset binary with the MSB as D5 and the LSB as D0. The row of pins closest to the board edge is digital output ground (OGND), while the data bits occupy the inside row. Located in the middle of the connector is the pin for the output clock labeled DCLK. This signal can be used to latch the parallel output data for capture into a logic analyzer or external DSP circuitry. Both digital outputs are updated on DCLK's rising edge (see the timing diagram in the MAX1002 or MAX1003 data sheet).

### Layout Considerations

The MAX1002/MAX1003 EV kit layouts have been optimized for high-speed signals. Careful attention has been given to grounding, power-supply bypassing, and signal-path layout to minimize coupling between the analog and digital sections of the circuit. For example, the ground plane has been removed under the tank circuitry to reduce stray capacitive loading on the relatively small capacitors required in the external resonant tank formed by C5, L1, and D1. Other layout considerations are detailed in the following sections.

### Power Supplies and Grounding

The EV kits feature separate analog and digital power supplies and grounds for best dynamic performance. A thin trace located on the backside of the circuit board near the VCC power-supply connector ties the analog and output ground planes together. This trace can be cut if the power-supply grounds are referenced elsewhere.

Referencing analog and digital grounds together at a single point usually avoids ground loops and corruption of sensitive analog circuitry by noise from the digital outputs. If the ground trace on the backside of the board is cut, observe the absolute maximum ratings between the two grounds.

# MAX1002/MAX1003 Evaluation Kits

## ***Bypassing***

Proper bypassing is essential to achieve the best dynamic performance from the converters. The MAX1002/MAX1003 EV kits use 10 $\mu$ F bypass capacitors located close to the power-supply connectors on the board to filter low-frequency supply ripple. High-frequency bypassing is accomplished with ceramic chip capacitors located very close to the device's supply pins.

As the digital outputs toggle, transient currents in the VCCO supply can couple into sensitive analog circuitry and severely degrade the converters' effective number of bits performance. Of particular concern is effectively bypassing VCCO to OGND. For best results, locate the bypass capacitors on the same side of the board and place them close to the device. This avoids the use of through-holes and results in lower series inductance. The capacitor size chosen for the EV kits (size 0603) keeps the layout compact. Finally, the modest value (47pF) and small size result in a high self-resonant frequency for effective high-frequency bypassing.

## ***Applications Information***

To achieve the full dynamic potential from the converters, minimize the capacitive loading on the digital outputs to reduce the transient currents at VCCO and OGND. The maximum capacitance per output bit should be less than 15pF. For example, the capacitance of the digital output traces and the J1 connector on the EV kits is about 3pF per trace. In an applications circuit, this could be further reduced by locating the digital receiving chip very close to the MAX1002/MAX1003 and removing the ground plane from under the output bit traces.

A logic analyzer can be connected to the J1 connector on the EV kits for evaluation purposes. The analyzer should be directly connected to the EV kit without any additional ribbon cables. Even a short length of ribbon cable can exceed the maximum recommended capacitive loading of the digital outputs. A typical high-speed logic analyzer probe adds about another 8pF loading per digital bit, which is acceptable for good dynamic performance.

**Evaluate: MAX1002/MAX1003**

# MAX1002/MAX1003 Evaluation Kits

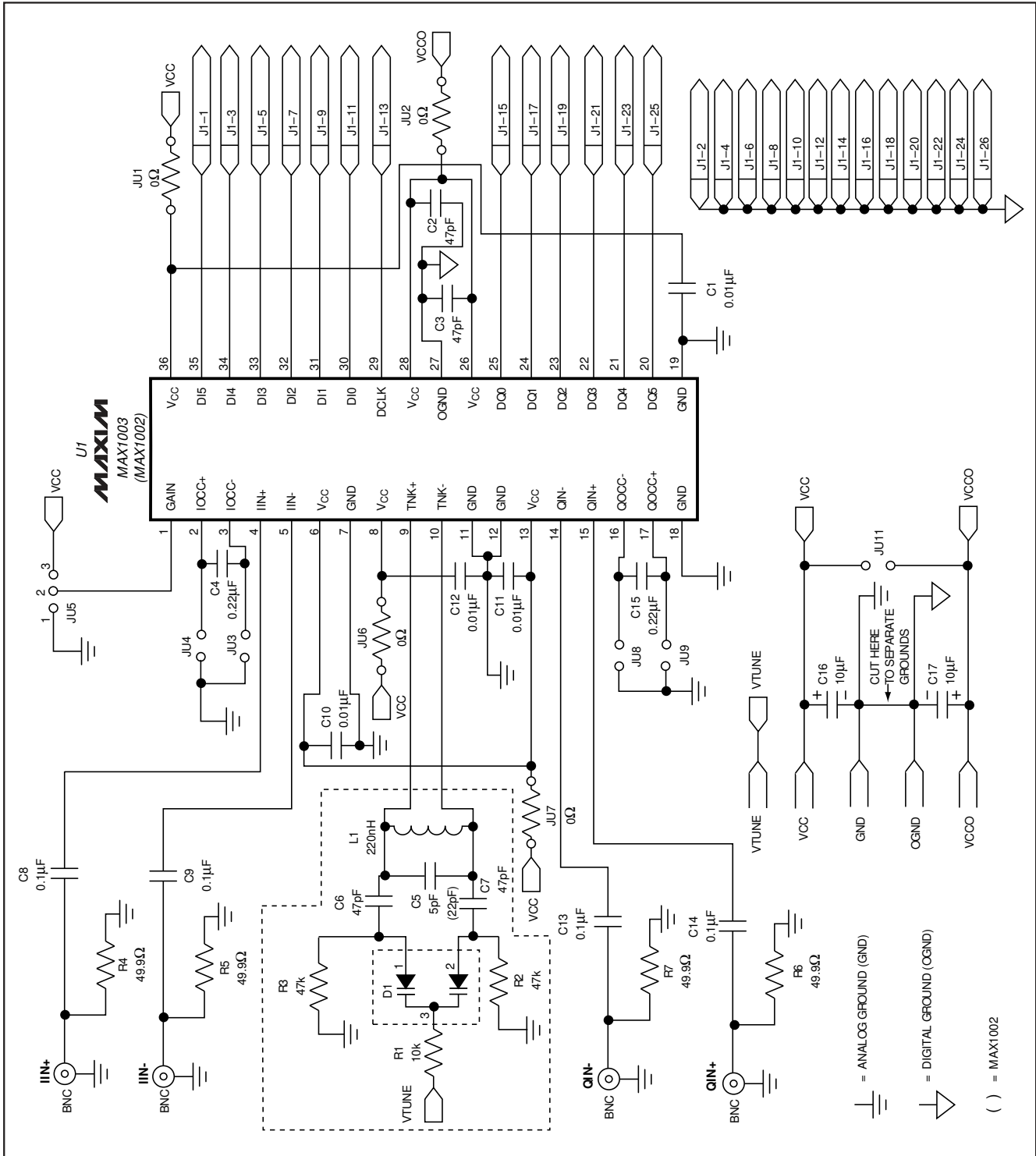

Figure 3. MAX1002/MAX1003 EV Kit Schematic (Voltage-Controlled-Oscillator Mode)



# MAX1002/MAX1003 Evaluation Kits

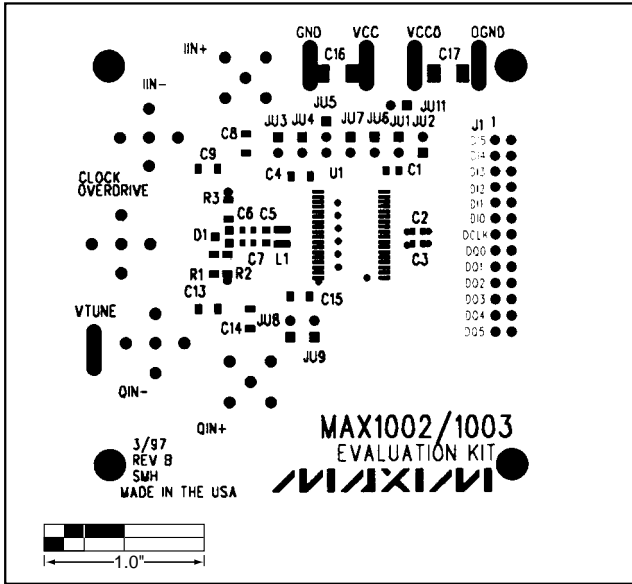

Figure 5. MAX1002/MAX1003 EV Kit Component Placement Guide—Component Side

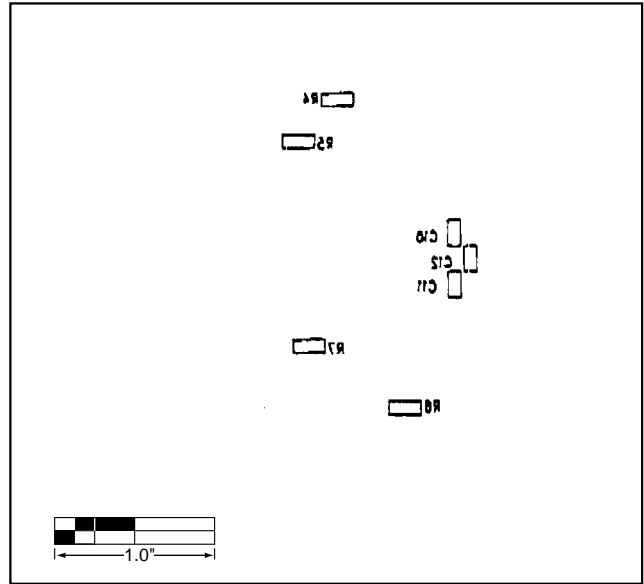

Figure 6. MAX1002/MAX1003 EV Kit Component Placement Guide—Solder Side

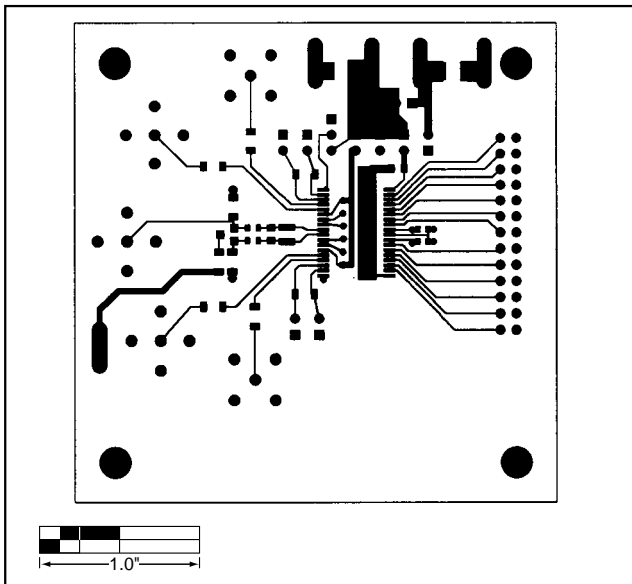

Figure 7. MAX1002/MAX1003 EV Kit PC Board Layout—Component Side

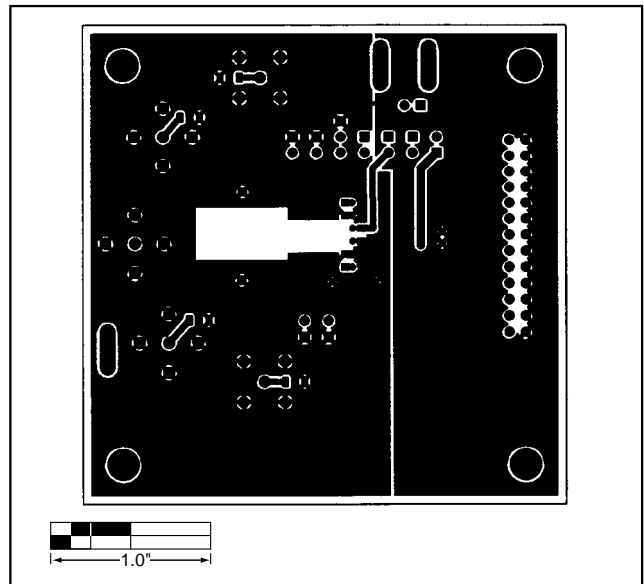

Figure 8. MAX1002/MAX1003 EV Kit PC Board Layout—Solder Side

Maxim cannot assume responsibility for use of any circuitry other than circuitry entirely embodied in a Maxim product. No circuit patent licenses are implied. Maxim reserves the right to change the circuitry and specifications without notice at any time.

8 Maxim Integrated Products, 120 San Gabriel Drive, Sunnyvale, CA 94086 (408) 737-7600