

TOP VIEW

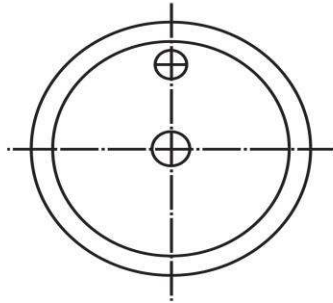

SIDE VIEW

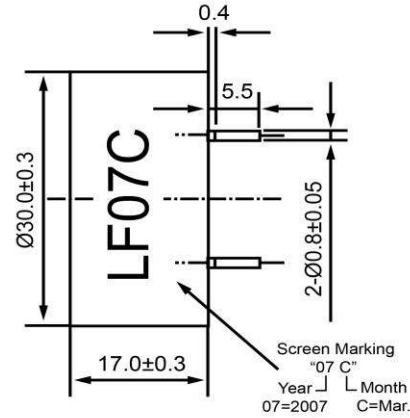

BOTTOM VIEW

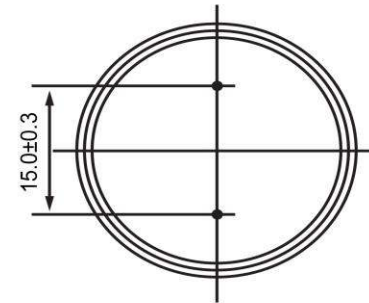

Specifications			Notes	Revision History					
Description	Value	Unit		Version	Description	Date	Approved		
Technology	Piezo		1) All dimensions are in mm unless otherwise noted 2) All parts meet RoHS 	1	Released from Engineering	10/21/2013	J.S		
Resonant Frequency	1,800	(Hz)							
Rated Voltage	12	(V)							
SPL @ 10cm	87	(dBA)							
Tone	Single								
Mount Type	Thru-hole								
Voltage Range	3 ~ 30	(V)							
Max Rated Current	12	(mA)							
Housing Material	ABS								
Operating Temperature	-20 ~ +70	°C							
Storage Temperature	-20 ~ +70	°C							
Weight	5	(g)							
				Piezo Indicator		IP301812-1			
				Drawn by	Date	Checked by	Date	Approved by	Date
				A.B.	10/21/2013	C.E.	10/21/2013	J.S	10/21/2013

Additional considerations can be found at www.dbunlimitedco.com/technical-articles.