

1200V SiC Schottky Diode

VDC	1200 V
Q _C	112 nC***
I _F	20 A***
T _{j,max}	175 °C

Amp+™ Features

- Unipolar rectifier with surge current
- Zero reverse recovery current
- Fast, temperature-independent switching
- Avalanche tested to 125mJ per leg*
- All parts tested to greater than 1,400V

Amp+™ Benefits

- Near zero switching loss
- Higher efficiency
- Smaller heat sink
- Easy to parallel

Amp+™ Applications

- Solar Inverters
- Switch mode power supplies, UPS
- Power factor correction
- EV charging stations

Package

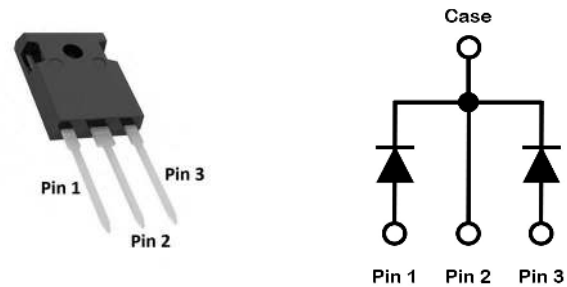

Part #	Package	Marking
GP3D020A120U	TO-247-3L	3D020A120



Maximum Ratings, at T_j=25 °C, unless otherwise specified

Characteristics Per Leg	Symbol	Conditions	Values	Unit
Continuous forward current	I _F **	T _C =25 °C, T _J =175 °C	34	A
		T _C =125 °C, T _J =175 °C	18	
		T _C =150 °C, T _J =175 °C	12	
Surge non-repetitive forward current sine halfwave	I _{FSM}	T _C =25 °C, t _p =8.3 ms	120	A
		T _C =110 °C, t _p =8.3 ms	110	
Non-repetitive peak forward current	I _{F,max}	T _C =25 °C, t _p =10 μs	700	A
i ² t value	∫i ² dt	T _C =25 °C, t _p =8.3 ms	60	A ² s
		T _C =110 °C, t _p =8.3 ms	50	
Repetitive peak reverse voltage	V _{RRM}	T _J =25 °C	1200	V
Diode dv/dt ruggedness	dv/dt	Turn-on slew rate, repetitive	200	V/ns
Power dissipation	P _{tot} **	T _C =25 °C	177	W
Operating junction & storage temperature	T _j , T _{storage}	Continuous	-55...175	°C
Soldering temperature	T _{solder}	Wave soldering leads	260	°C
Mounting torque		M3 Screw	1	N-m

Notes:

* EAS of 125 mJ is based on starting T_j = 25°C, L = 1.0 mH, IAS = 15.81 A, V = 50 V.

** Typical R_{thJC} used

*** Per Device

Electrical Characteristics, at $T_j=25\text{ }^\circ\text{C}$, unless otherwise specified

Characteristics Per Leg	Symbol	Conditions	Values			Unit
			min.	typ.	max.	
DC blocking voltage	V_{DC}	$T_j=25\text{ }^\circ\text{C}$	1200	-	-	V
Breakdown voltage	V_{BR}	$I_R=1.00\text{mA}$, $T_j=25\text{ }^\circ\text{C}$	1400	-	-	V
Diode forward voltage	V_F	$I_F=10\text{A}$, $T_j=25\text{ }^\circ\text{C}$	-	1.50	1.65	V
		$I_F=10\text{A}$, $T_j=125\text{ }^\circ\text{C}$	-	1.83	-	
		$I_F=10\text{A}$, $T_j=175\text{ }^\circ\text{C}$	-	2.11	2.70	
Reverse current	I_R	$V_R=1,200\text{V}$, $T_j=25\text{ }^\circ\text{C}$	-	2	20	μA
		$V_R=1,400\text{V}$, $T_j=25\text{ }^\circ\text{C}$	-	7	-	
		$V_R=1,200\text{V}$, $T_j=125\text{ }^\circ\text{C}$	-	11	-	
		$V_R=1,200\text{V}$, $T_j=175\text{ }^\circ\text{C}$	-	39	300	
Total capacitive charge	Q_C	$V_R=800\text{V}$, $T_j=25\text{ }^\circ\text{C}$	-	56	-	nC
Total capacitance	C	$V_R=1\text{V}$, $f=1\text{ MHz}$	-	608	-	pF
		$V_R=400\text{V}$, $f=1\text{ MHz}$	-	53	-	
		$V_R=800\text{V}$, $f=1\text{ MHz}$	-	39	-	

Thermal Characteristics

Characteristics Per Leg	Symbol	Conditions	Values			Unit
			min.	typ.	max.	
Thermal resistance, junction-case	R_{thJC}	-	-	0.85	1.11	$^\circ\text{C/W}$

Typical Performance Per Leg

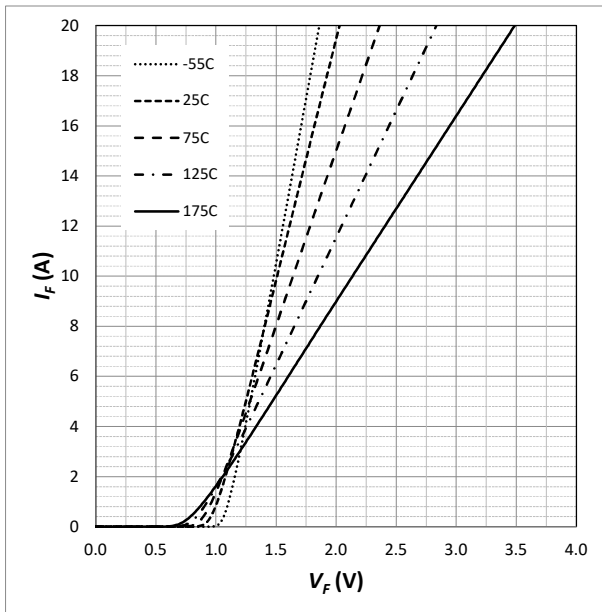

Fig. 1 Forward Characteristics (parameterized on T_j)

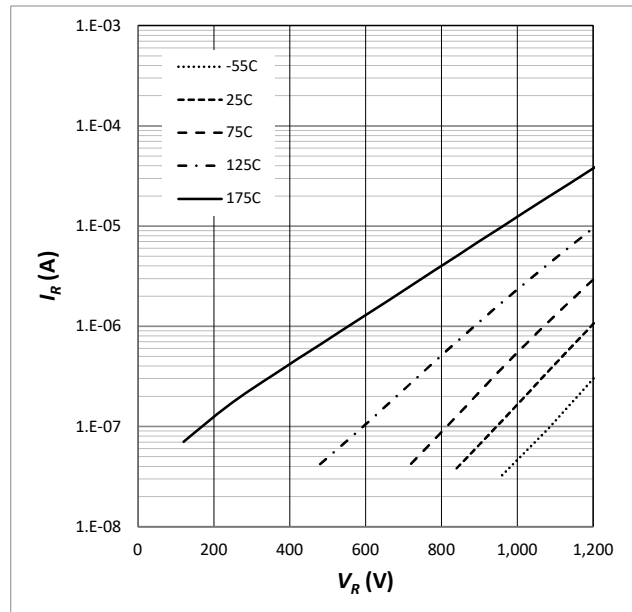

Fig. 2 Reverse Characteristics (parameterized on T_j)

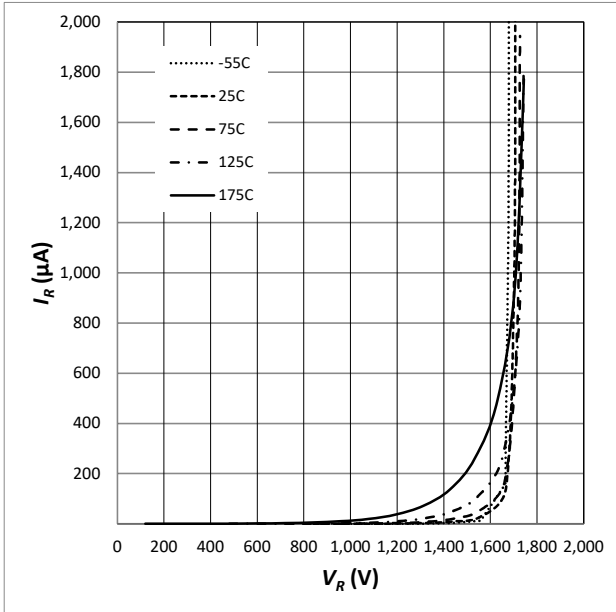

Fig. 3 Reverse Characteristics (parameterized on T_j)

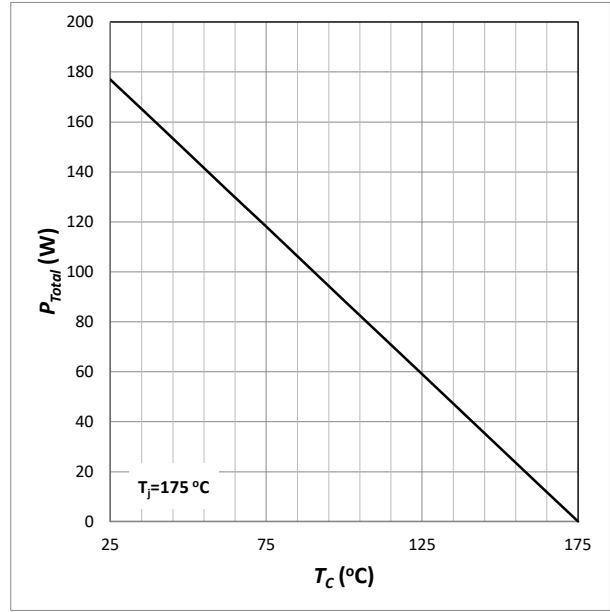

Fig. 4 Power Derating

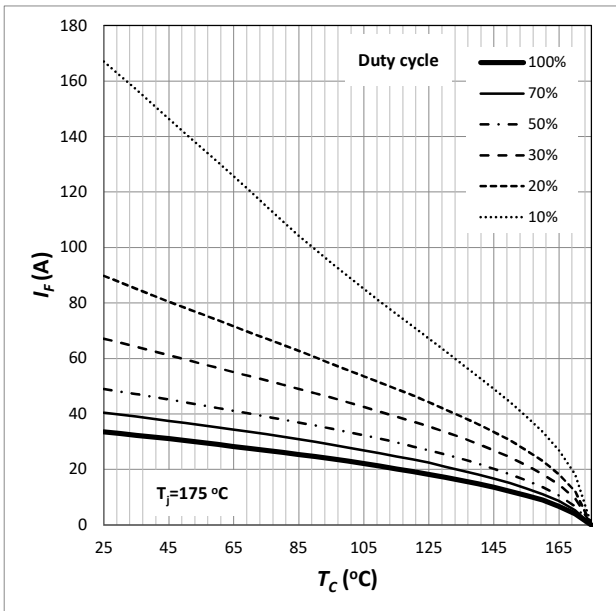

Fig. 5 Capacitance

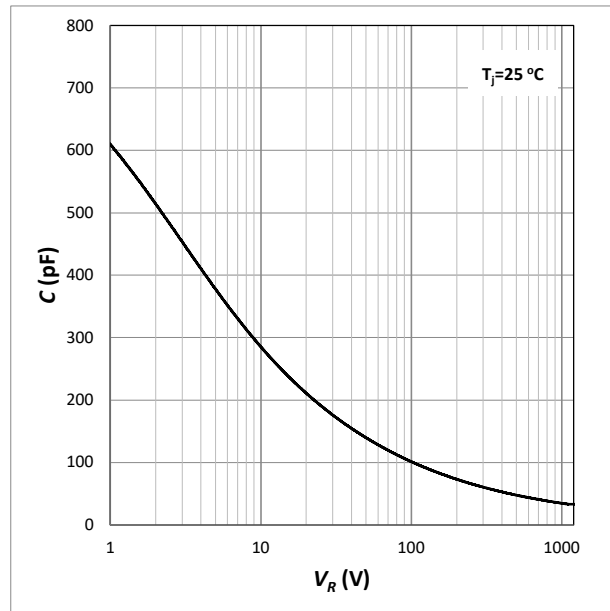

Fig. 6 Capacitance

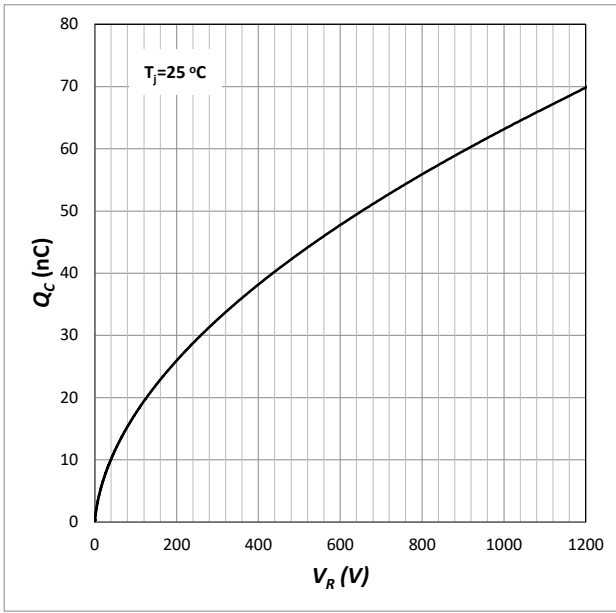

Fig. 7 Capacitive Charge

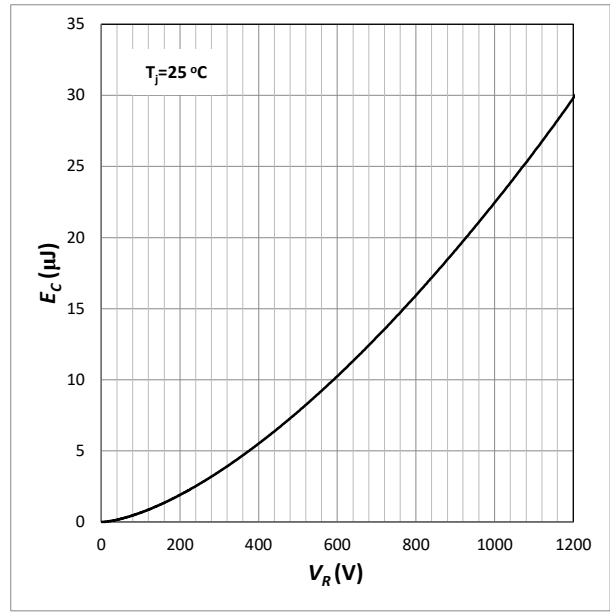

Fig. 8 Typical Capacitance Stored Energy

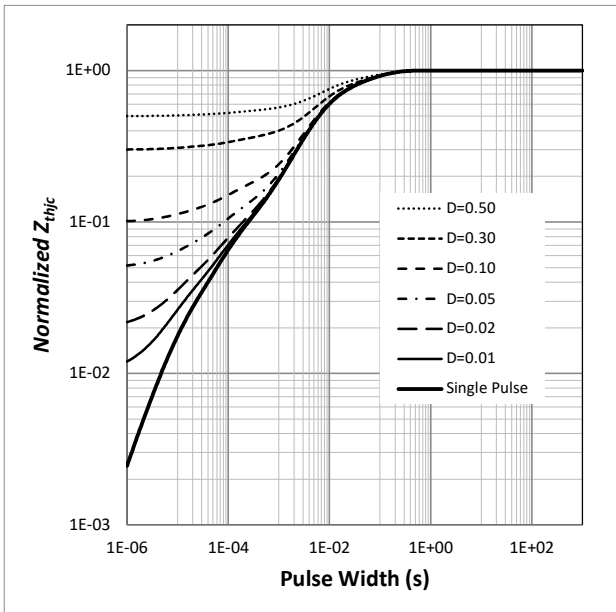

Fig. 9 Transient Thermal Impedance

1200V SiC Schottky Diode

Amp+™

GP3D020A120U

Package Dimensions TO-247-3L

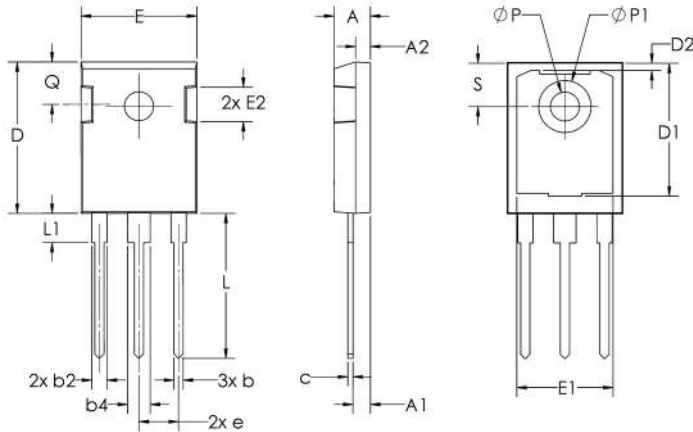

Sym	Millimeters		Inches	
	Min	Max	Min	Max
A	4.70	5.31	0.185	0.209
A1	2.21	2.59	0.087	0.102
A2	1.50	2.49	0.059	0.098
b	0.99	1.40	0.039	0.055
b2	1.65	2.39	0.065	0.094
b4	2.59	3.43	0.102	0.135
c	0.38	0.89	0.015	0.035
D	20.80	21.46	0.819	0.845
D1	13.08	17.65	0.515	0.695
D2	0.51	1.35	0.020	0.053
E	15.49	16.26	0.610	0.640
E1	13.46	14.16	0.530	0.557
E2	3.43	5.49	0.135	0.216
e	5.44 BSC		0.214 BSC	
L	19.81	20.32	0.780	0.800
L1	4.10	4.50	0.161	0.177
ØP	3.56	3.66	0.140	0.144
ØP1	7.06	7.39	0.278	0.291
Q	5.39	6.20	0.212	0.244
S	6.04	6.30	0.238	0.248

Notes

RoHS Compliance

The levels of RoHS restricted materials in this product are below the maximum concentration values (also referred to as the threshold limits) permitted for such substances, or are used in an exempted application, in accordance with EU Directive 2011/65/EC (RoHS2), as implemented March, 2013. RoHS Declarations for this product can be obtained from the Product Documentation sections of www.SemiQ.com.

REACH Compliance

REACH substances of high concern (SVHC) information is available for this product. Since the European Chemicals Agency (ECHA) has published notice of their intent to frequently revise the SVHC listing for the foreseeable future, please contact our office at SemiQ Headquarters in Lake Forest, California to insure you get the most up-to-date REACH SVHC Declaration. REACH banned substance information (REACH Article 67) is also available upon request.

SemiQ Inc., reserves the right to make changes to the product specifications and data in this document without notice. SemiQ products are sold pursuant to SemiQ's terms and conditions of sale in place at the time of order acknowledgement.

This product has not been designed or tested for use in, and is not intended for use in, applications implanted into the human body nor in applications in which failure of the product could lead to death, personal injury or property damage, including but not limited to equipment used in the operation of nuclear facilities, life-support machines, cardiac defibrillators or similar emergency medical equipment, aircraft navigation or communication or control systems, or air traffic control.

SemiQ makes no warranty, representation or guarantee regarding the suitability of its products for any particular purpose, nor does SemiQ assume any liability arising out of the application or use of any product or circuit, and specifically disclaims any and all liability, including without limitation special, consequential or incidental damages. Buyer is responsible for its products and applications using SemiQ products.

To obtain additional technical information or to place an order for this product, please contact us. The information in this datasheet is provided by SemiQ. SemiQ reserves the right to make changes, corrections, modifications, and improvements of datasheet without notice.