

# RF Power Field Effect Transistors

## N-Channel Enhancement-Mode Lateral MOSFETs

Designed for broadband commercial and industrial applications with frequencies up to 500 MHz. The high gain and broadband performance of these devices make them ideal for large-signal, common-source amplifier applications in 28 volt base station equipment.

- Typical Single-Carrier N-CDMA Performance @ 465 MHz:  $V_{DD} = 28$  Volts,  $I_{DQ} = 1100$  mA,  $P_{out} = 25$  Watts Avg., IS-95 CDMA (Pilot, Sync, Paging, Traffic Codes 8 Through 13). Channel Bandwidth = 1.2288 MHz. PAR = 9.8 dB @ 0.01% Probability on CCDF.  
 Power Gain — 23 dB  
 Drain Efficiency — 30.2%  
 ACPR @ 750 kHz Offset — -47.6 dBc in 30 kHz Bandwidth
- Capable of Handling 10:1 VSWR, @ 28 Vdc, 465 MHz, 125 Watts CW Output Power

### Features

- Characterized with Series Equivalent Large-Signal Impedance Parameters
- Internally Matched for Ease of Use
- Qualified Up to a Maximum of 32  $V_{DD}$  Operation
- Integrated ESD Protection
- 200°C Capable Plastic Package
- RoHS Compliant
- In Tape and Reel. R1 Suffix = 500 Units per 44 mm, 13 inch Reel.

**MRF5S4125NR1**  
**MRF5S4125NBR1**

**450-480 MHz, 25 W AVG., 28 V**  
**SINGLE N-CDMA**  
**LATERAL N-CHANNEL**  
**RF POWER MOSFETs**

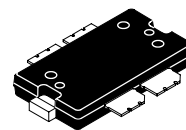

**CASE 1486-03, STYLE 1**  
**TO-270 WB-4**  
**MRF5S4125NR1**

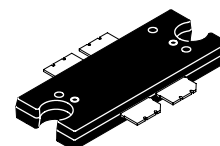

**CASE 1484-04, STYLE 1**  
**TO-272 WB-4**  
**MRF5S4125NBR1**

**Table 1. Maximum Ratings**

Rating	Symbol	Value	Unit
Drain-Source Voltage	$V_{DSS}$	-0.5, +65	Vdc
Gate-Source Voltage	$V_{GS}$	-0.5, +15	Vdc
Storage Temperature Range	$T_{stg}$	-65 to +150	°C
Operating Junction Temperature (1,2)	$T_J$	200	°C

**Table 2. Thermal Characteristics**

Characteristic	Symbol	Value (2,3)	Unit
Thermal Resistance, Junction to Case	$R_{\theta JC}$		°C/W
Case Temperature 90°C, 125 W CW		0.33	
Case Temperature 90°C, 25 W CW		0.43	

1. Continuous use at maximum temperature will affect MTTF.
2. MTTF calculator available at <http://www.freescale.com/rf>. Select Tools/Software/Application Software/Calculators to access the MTTF calculators by product.
3. Refer to AN1955, *Thermal Measurement Methodology of RF Power Amplifiers*. Go to <http://www.freescale.com/rf>. Select Documentation/Application Notes - AN1955.

LIFETIME BUY

LAST ORDER 1 JUL 11 LAST SHIP 30 JUN 12

**Table 3. ESD Protection Characteristics**

Test Methodology	Class
Human Body Model (per JESD22-A114)	1B (Minimum)
Machine Model (per EIA/JESD22-A115)	A (Minimum)
Charge Device Model (per JESD22-C101)	IV (Minimum)

**Table 4. Moisture Sensitivity Level**

Test Methodology	Rating	Package Peak Temperature	Unit
Per JESD 22-A113, IPC/JEDEC J-STD-020	3	260	°C

**Table 5. Electrical Characteristics** ( $T_C = 25^\circ\text{C}$  unless otherwise noted)

Characteristic	Symbol	Min	Typ	Max	Unit
----------------	--------	-----	-----	-----	------

**Off Characteristics**

Zero Gate Voltage Drain Leakage Current ( $V_{DS} = 65\text{ Vdc}$ , $V_{GS} = 0\text{ Vdc}$ )	$I_{DSS}$	—	—	10	$\mu\text{Adc}$
Zero Gate Voltage Drain Leakage Current ( $V_{DS} = 28\text{ Vdc}$ , $V_{GS} = 0\text{ Vdc}$ )	$I_{DSS}$	—	—	1	$\mu\text{Adc}$
Gate-Source Leakage Current ( $V_{GS} = 5\text{ Vdc}$ , $V_{DS} = 0\text{ Vdc}$ )	$I_{GSS}$	—	—	10	$\mu\text{Adc}$

**On Characteristics**

Gate Threshold Voltage ( $V_{DS} = 10\text{ Vdc}$ , $I_D = 400\ \mu\text{Adc}$ )	$V_{GS(th)}$	2	3	4	Vdc
Gate Quiescent Voltage ( $V_{DS} = 28\text{ Vdc}$ , $I_D = 1100\text{ mAdc}$ , Measured in Functional Test)	$V_{GS(Q)}$	3.5	4.25	5	Vdc
Drain-Source On-Voltage ( $V_{GS} = 10\text{ Vdc}$ , $I_D = 1.5\text{ Adc}$ )	$V_{DS(on)}$	0.05	0.175	0.3	Vdc

**Dynamic Characteristics (1)**

Reverse Transfer Capacitance ( $V_{DS} = 28\text{ Vdc} \pm 30\text{ mV(rms)ac}$ @ 1 MHz, $V_{GS} = 0\text{ Vdc}$ )	$C_{rss}$	—	2.41	—	pF
Output Capacitance ( $V_{DS} = 28\text{ Vdc} \pm 30\text{ mV(rms)ac}$ @ 1 MHz, $V_{GS} = 0\text{ Vdc}$ )	$C_{oss}$	—	74.61	—	pF

**Functional Tests** (In Freescale Test Fixture, 50 ohm system)  $V_{DD} = 28\text{ Vdc}$ ,  $I_{DQ} = 1100\text{ mA}$ ,  $P_{out} = 25\text{ W Avg}$ . N-CDMA,  $f = 465\text{ MHz}$ , Single-Carrier N-CDMA, 1.2288 MHz Channel Bandwidth Carrier. ACPR measured in 30 kHz Channel Bandwidth @  $\pm 750\text{ kHz}$  Offset. PAR = 9.8 dB @ 0.01% Probability on CCDF.

Power Gain	$G_{ps}$	22	23	25	dB
Drain Efficiency	$\eta_D$	28	30.2	—	%
Adjacent Channel Power Ratio	ACPR	—	-47.6	-45	dBc
Input Return Loss	IRL	—	-15	-9	dB

1. Part internally input matched.

LIFETIME BUY

LAST ORDER 1 JUL 11 LAST SHIP 30 JUN 12

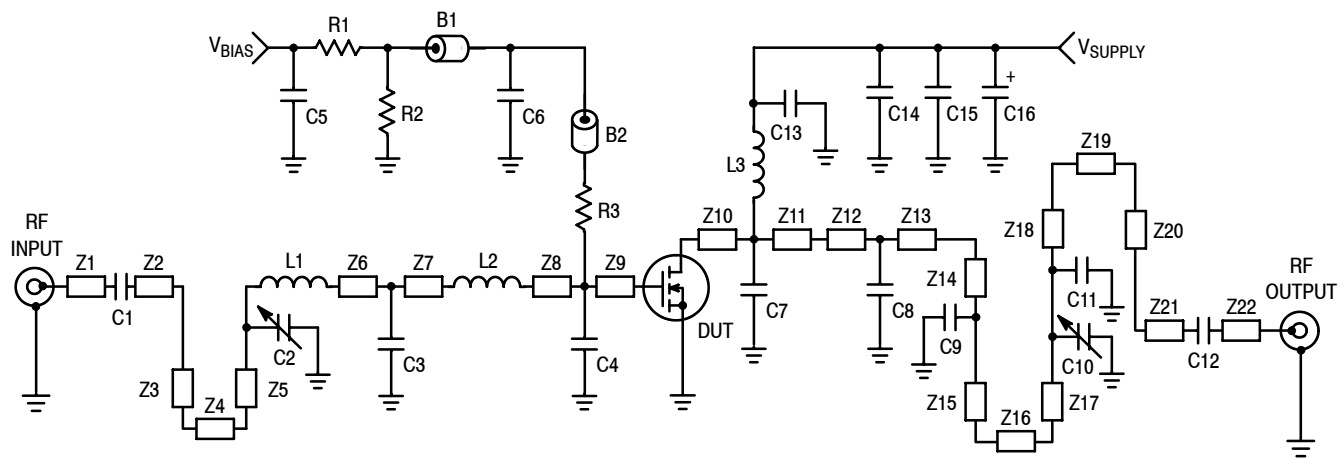

Z1	0.186" x 0.084" Microstrip	Z13	0.063" x 0.084" Microstrip
Z2	0.206" x 0.084" Microstrip	Z14	0.315" x 0.084" Microstrip
Z3	1.171" x 0.084" Microstrip	Z15	0.473" x 0.084" Microstrip
Z4	0.275" x 0.084" Microstrip	Z16	0.522" x 0.084" Microstrip
Z5	0.985" x 0.084" Microstrip	Z17	0.448" x 0.084" Microstrip
Z6, Z7	0.130" x 0.084" Microstrip	Z18	0.628" x 0.084" Microstrip
Z8	0.131" x 0.084" Microstrip	Z19	0.291" x 0.084" Microstrip
Z9	0.675" x 0.504" Microstrip	Z20	0.318" x 0.084" Microstrip
Z10	0.397" x 0.656" Microstrip	Z21	0.202" x 0.084" Microstrip
Z11	0.071" x 0.084" Microstrip	Z22	0.190" x 0.084" Microstrip
Z12	0.008" x 0.084" Microstrip	PCB	Arlon AD250, 0.030", $\epsilon_r = 2.5$

**Figure 1. MRF5S4125NR1(NBR1) Test Circuit Schematic**

**Table 6. MRF5S4125NR1(NBR1) Test Circuit Component Designations and Values**

Part	Description	Part Number	Manufacturer
B1, B2	Ferrite Beads, Short	2743019447	Fair-Rite
C1, C6, C12, C13	120 pF Chip Capacitors	ATC600B121BT250XT	ATC
C2, C10	0.8–8.0 pF, Variable Capacitors, Gigatrim	27291SL	Johanson
C3, C9	20 pF Chip Capacitors	ATC600B200BT250XT	ATC
C4	8.2 pF Chip Capacitor	ATC600B8R2BT250XT	ATC
C5, C14, C15	10 $\mu$ F, 50 V Chip Capacitors	GRM55DR61H106KA88L	Murata
C7	27 pF Chip Capacitor	ATC600B270BT250XT	ATC
C8	47 pF Chip Capacitor	ATC600B470BT250XT	ATC
C11	3.3 pF Chip Capacitor	ATC600B3R3BT250XT	ATC
C16	22 $\mu$ F, 35 V Tantalum Capacitor	T491X226K035A5	Kemet
L1, L2	1.6 nH Inductors	0906-2	Coilcraft
L3	27 nH Inductor	1812SMS-27N_L	Coilcraft
R1	1000 $\Omega$ , 1/4 W Chip Resistor	CRCW12061001FKTA	Vishay
R2	10 k $\Omega$ , 1/4 W Chip Resistor	CRCW12061002FKTA	Vishay
R3	100 $\Omega$ , 1/4 W Chip Resistor	CRCW1206100RFKTA	Vishay

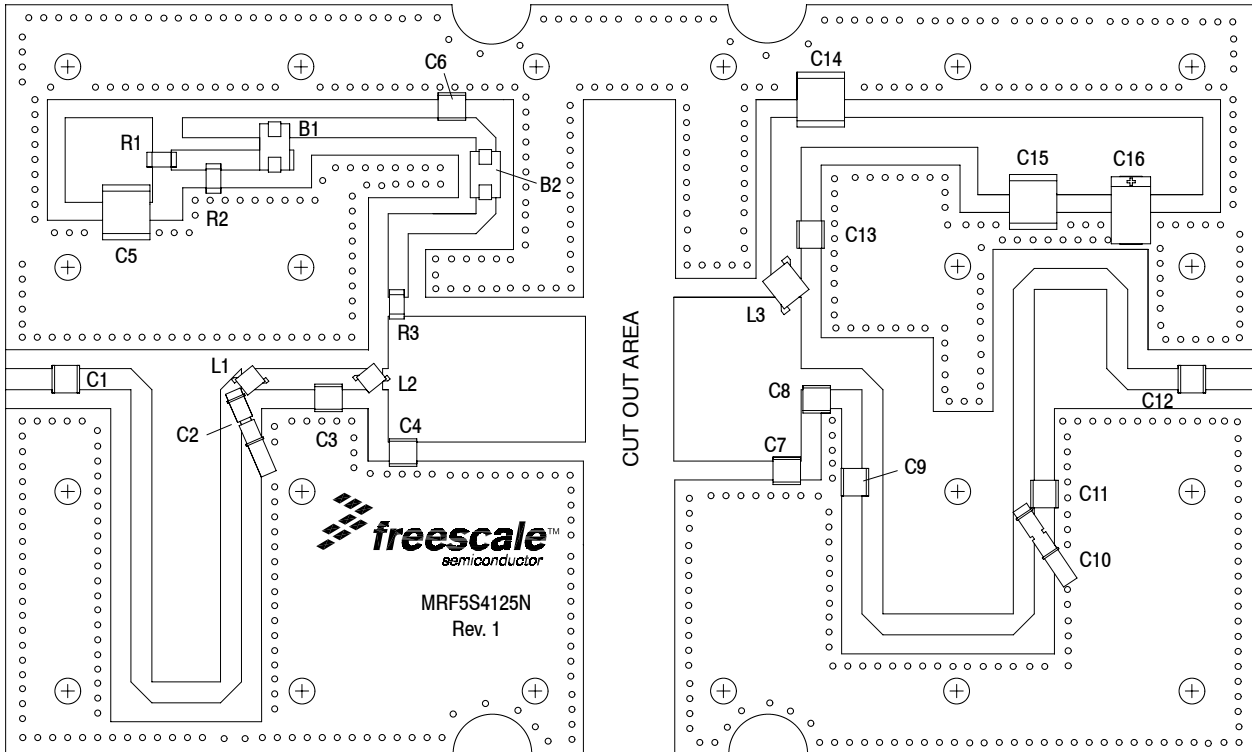

Figure 2. MRF5S4125NR1(NBR1) Test Circuit Component Layout

### TYPICAL CHARACTERISTICS

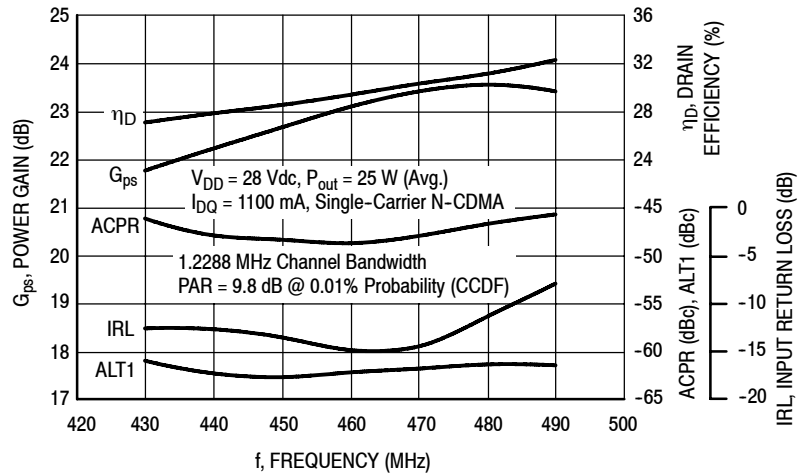

Figure 3. Single-Carrier N-CDMA Broadband Performance @  $P_{out} = 25$  Watts Avg.

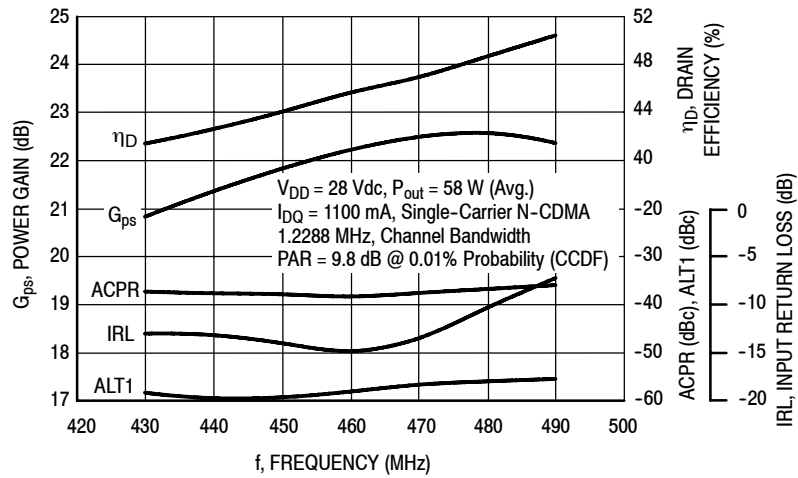

Figure 4. Single-Carrier N-CDMA Broadband Performance @  $P_{out} = 58$  Watts Avg.

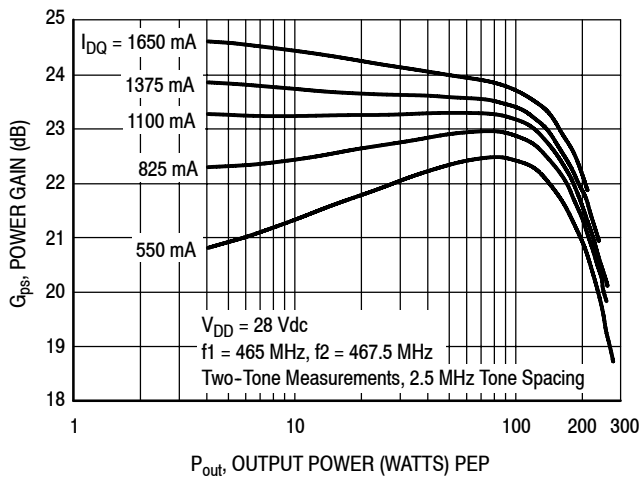

Figure 5. Two-Tone Power Gain versus Output Power

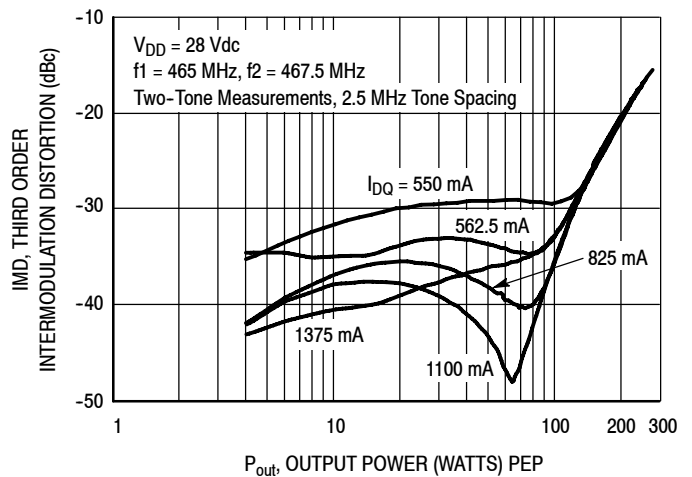
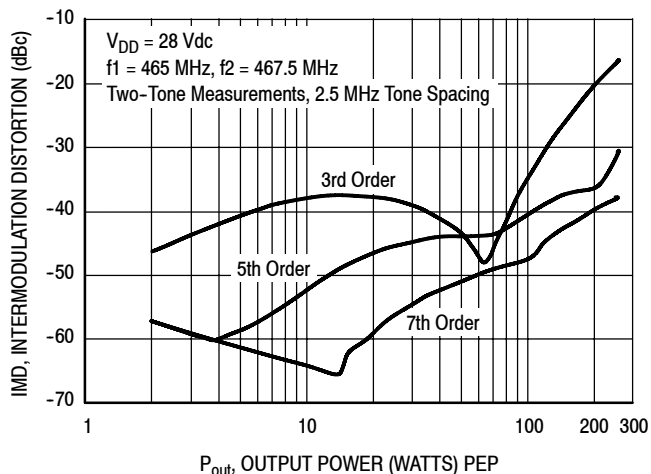

Figure 6. Third Order Intermodulation Distortion versus Output Power

LIFETIME BUY

LAST ORDER 1 JUL 11 LAST SHIP 30 JUN 12

### TYPICAL CHARACTERISTICS



**Figure 7. Intermodulation Distortion Products versus Output Power**

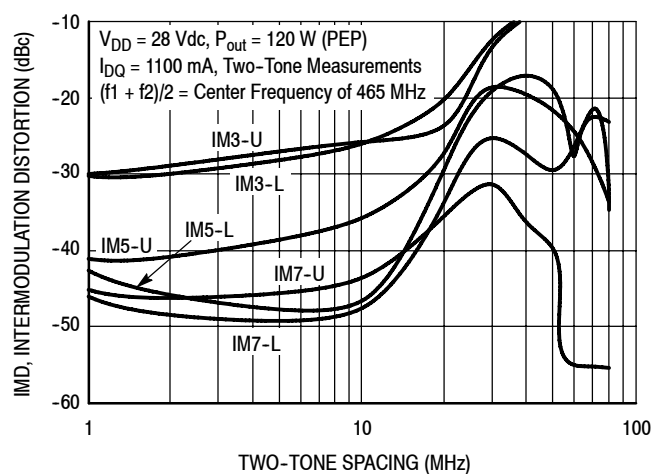

**Figure 8. Intermodulation Distortion Products versus Tone Spacing**

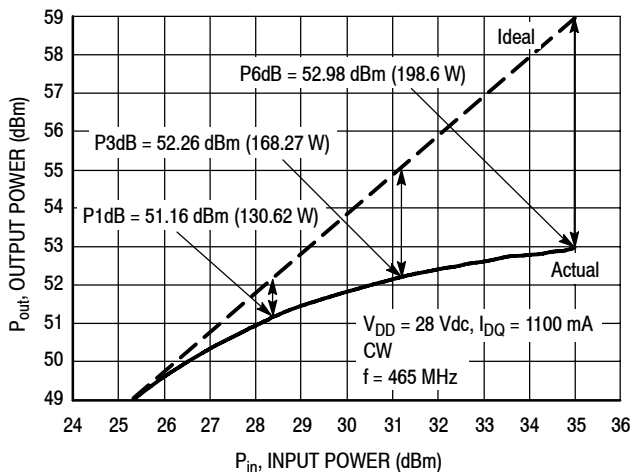

**Figure 9. Pulsed CW Output Power versus Input Power**

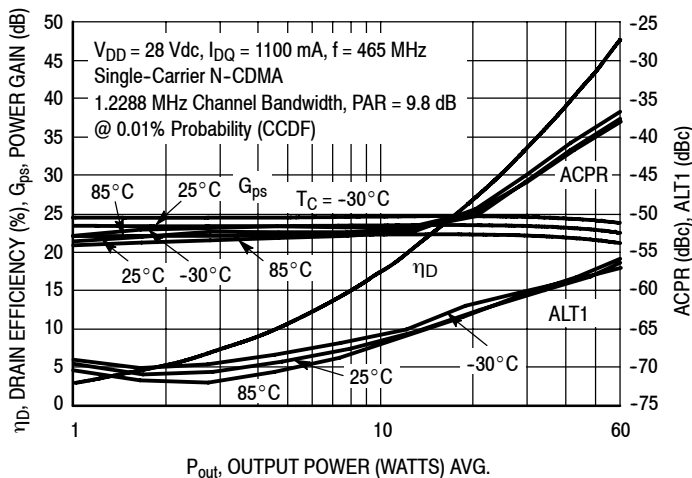
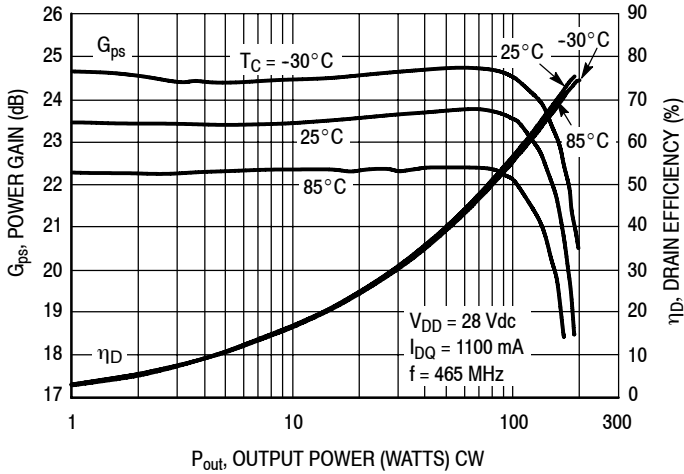

**Figure 10. Single-Carrier N-CDMA ACPR, ALT1, Power Gain and Drain Efficiency versus Output Power**

LIFETIME BUY

LAST ORDER 1 JUL 11 LAST SHIP 30 JUN 12

### TYPICAL CHARACTERISTICS



**Figure 11. Power Gain and Drain Efficiency versus CW Output Power**

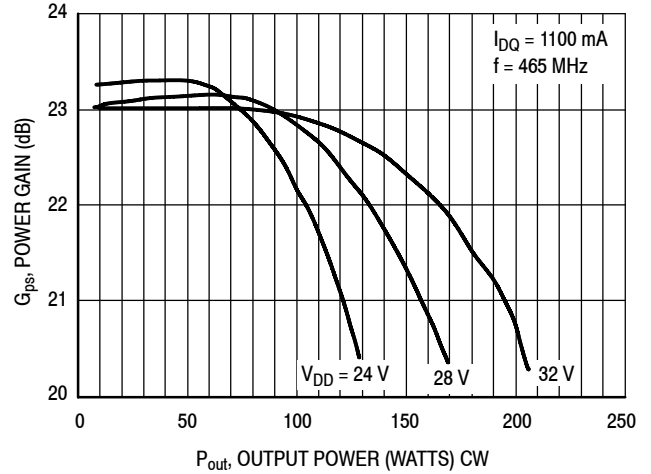

**Figure 12. Power Gain versus Output Power**

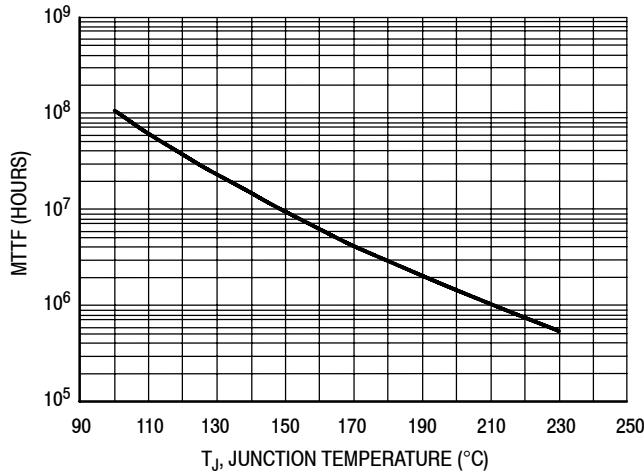

This above graph displays calculated MTTF in hours when the device is operated at  $V_{DD} = 28$  Vdc,  $P_{out} = 25$  W Avg., and  $\eta_D = 30.2\%$ .

MTTF calculator available at <http://www.freescale.com/rf>. Select Tools/Software/Application Software/Calculators to access the MTTF calculators by product.

**Figure 13. MTTF versus Junction Temperature**

LIFETIME BUY

LAST ORDER 1 JUL 11 LAST SHIP 30 JUN 12

### N-CDMA TEST SIGNAL

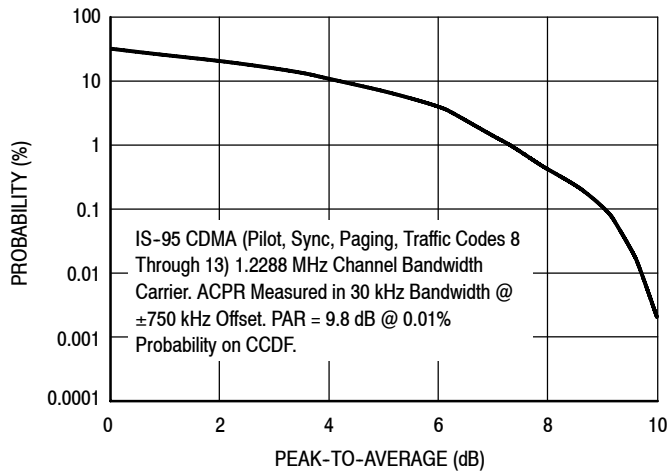

**Figure 14. Single-Carrier CCDF N-CDMA**

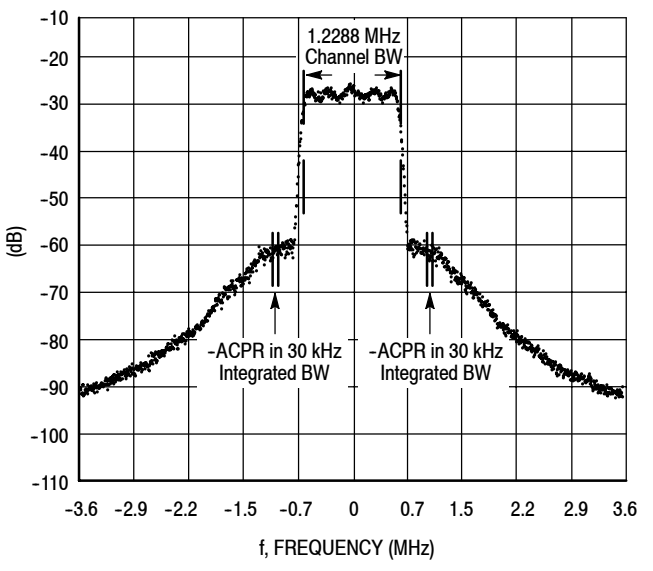
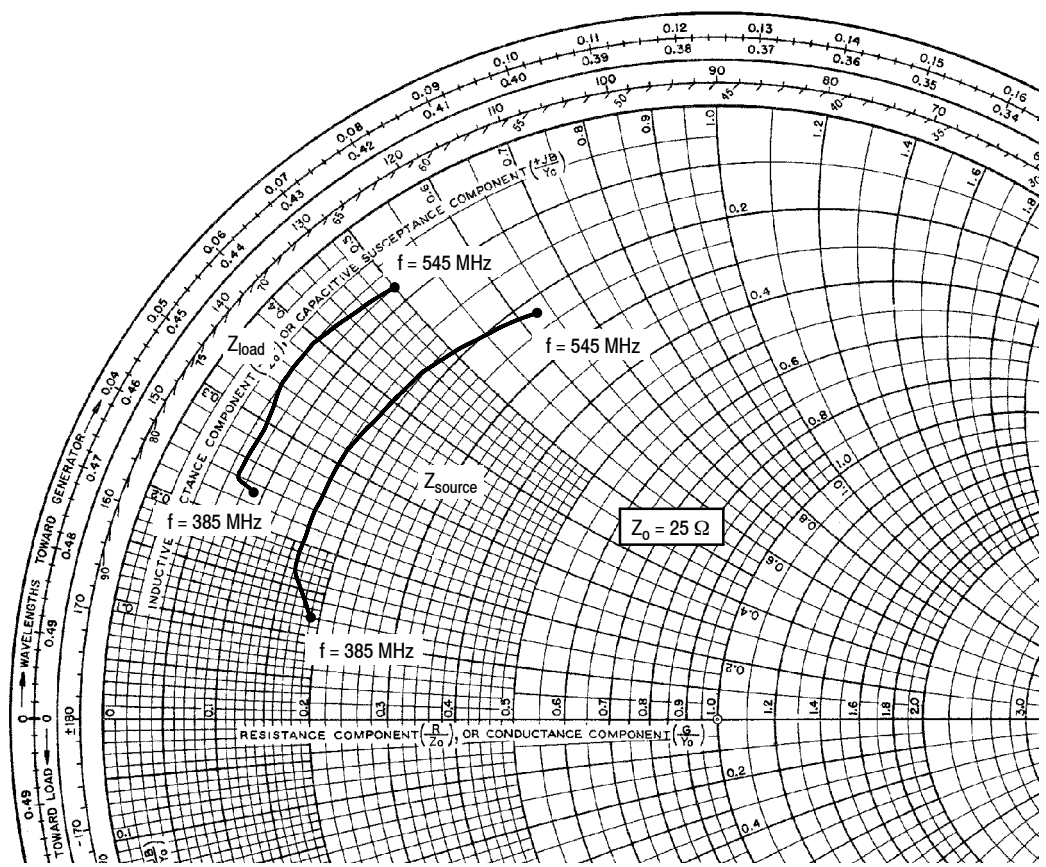

**Figure 15. Single-Carrier N-CDMA Spectrum**

LIFETIME BUY

LAST ORDER 1 JUL 11 LAST SHIP 30 JUN 12





$V_{DD} = 28 \text{ Vdc}$ ,  $I_{DQ} = 1100 \text{ mA}$ ,  $P_{out} = 25 \text{ W Avg.}$

f MHz	$Z_{source}$ $\Omega$	$Z_{load}$ $\Omega$
385	$4.735 + j2.917$	$2.229 + j5.627$
405	$4.073 + j4.202$	$1.809 + j6.123$
425	$3.987 + j5.466$	$1.842 + j6.684$
445	$3.909 + j6.743$	$1.767 + j7.187$
465	$4.094 + j7.661$	$1.822 + j7.338$
485	$4.128 + j9.483$	$1.566 + j8.397$
505	$4.446 + j11.620$	$1.525 + j9.787$
525	$4.921 + j13.710$	$1.769 + j11.120$
545	$5.437 + j15.838$	$2.023 + j12.467$

$Z_{source}$  = Test circuit impedance as measured from gate to ground.

$Z_{load}$  = Test circuit impedance as measured from drain to ground.

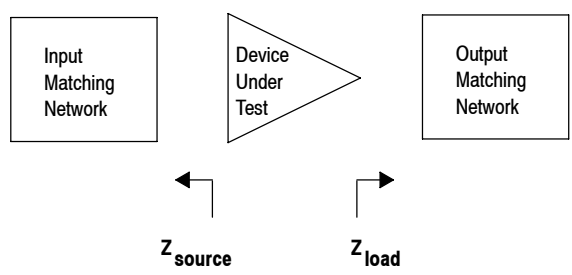
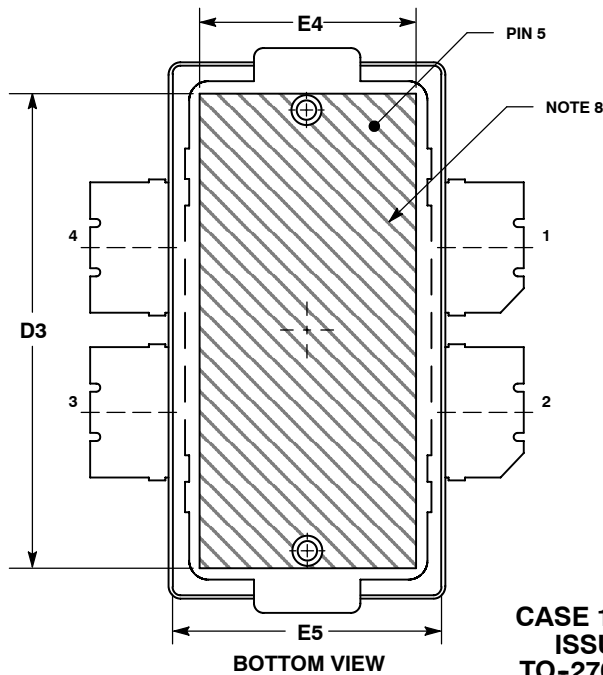
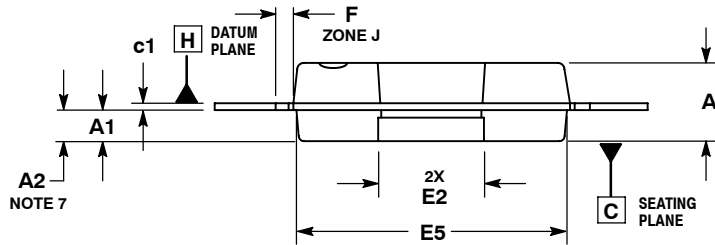
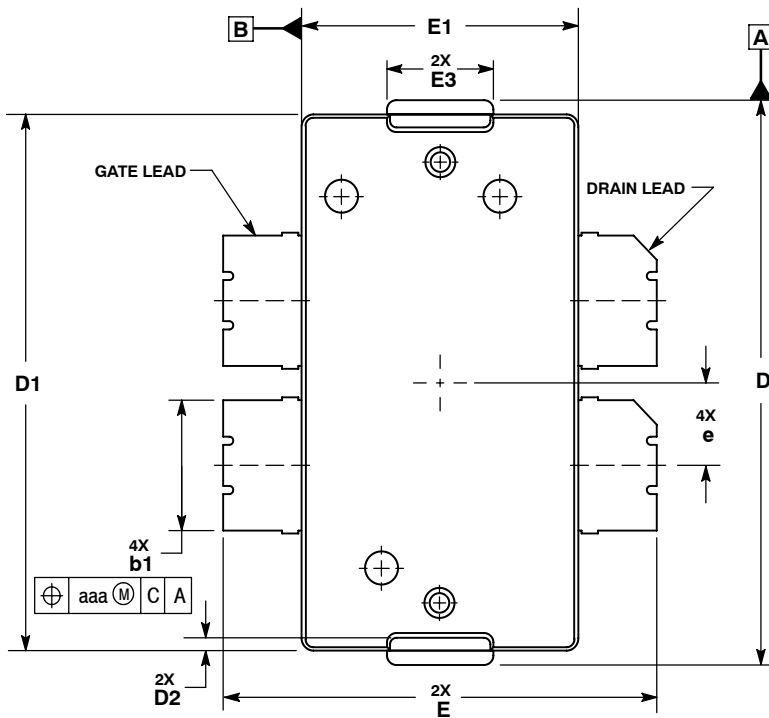

Figure 16. Series Equivalent Source and Load Impedance

### PACKAGE DIMENSIONS



**CASE 1486-03  
ISSUE C  
TO-270 WB-4  
PLASTIC  
MRF5S4125NR1**

**NOTES:**

1. CONTROLLING DIMENSION: INCH.
2. INTERPRET DIMENSIONS AND TOLERANCES PER ASME Y14.5M-1994.
3. DATUM PLANE -H- IS LOCATED AT THE TOP OF LEAD AND IS COINCIDENT WITH THE LEAD WHERE THE LEAD EXITS THE PLASTIC BODY AT THE TOP OF THE PARTING LINE.
4. DIMENSIONS "D" AND "E1" DO NOT INCLUDE MOLD PROTRUSION. ALLOWABLE PROTRUSION IS .006 PER SIDE. DIMENSIONS "D" AND "E1" DO INCLUDE MOLD MISMATCH AND ARE DETERMINED AT DATUM PLANE -H-.
5. DIMENSION "b1" DOES NOT INCLUDE DAMBAR PROTRUSION. ALLOWABLE DAMBAR PROTRUSION SHALL BE .005 TOTAL IN EXCESS OF THE "b1" DIMENSION AT MAXIMUM MATERIAL CONDITION.
6. DATUMS -A- AND -B- TO BE DETERMINED AT DATUM PLANE -H-.
7. DIMENSION A2 APPLIES WITHIN ZONE "J" ONLY.
8. HATCHING REPRESENTS THE EXPOSED AREA OF THE HEAT SLUG.

DIM	INCHES		MILLIMETERS	
	MIN	MAX	MIN	MAX
A	.100	.104	2.54	2.64
A1	.039	.043	0.99	1.09
A2	.040	.042	1.02	1.07
D	.712	.720	18.08	18.29
D1	.688	.692	17.48	17.58
D2	.011	.019	0.28	0.48
D3	.600	---	15.24	---
E	.551	.559	14	14.2
E1	.353	.357	8.97	9.07
E2	.132	.140	3.35	3.56
E3	.124	.132	3.15	3.35
E4	.270	---	6.86	---
E5	.346	.350	8.79	8.89
F	.025 BSC		0.64 BSC	
b1	.164	.170	4.17	4.32
c1	.007	.011	0.18	0.28
e	.106 BSC		2.69 BSC	
aaa	.004		0.10	

**STYLE 1:**

- PIN 1. DRAIN
2. DRAIN
3. GATE
4. GATE
5. SOURCE

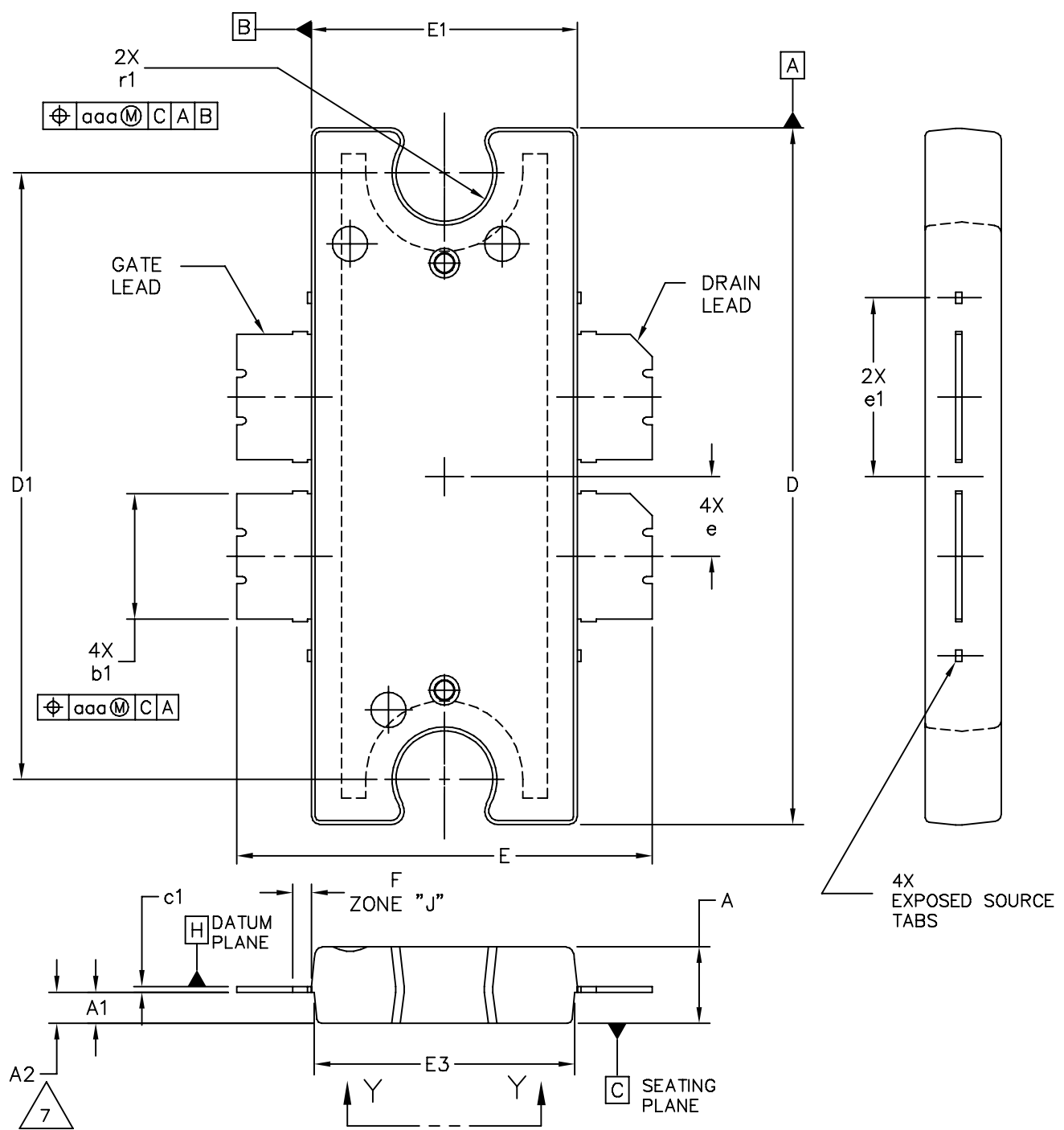

© FREESCALE SEMICONDUCTOR, INC. ALL RIGHTS RESERVED.		<b>MECHANICAL OUTLINE</b>		PRINT VERSION NOT TO SCALE	
TITLE:  TO-272 4 LEAD, WIDE BODY			DOCUMENT NO: 98ASA10575D		REV: D
			CASE NUMBER: 1484-04		05 APR 2006
			STANDARD: NON-JEDEC		

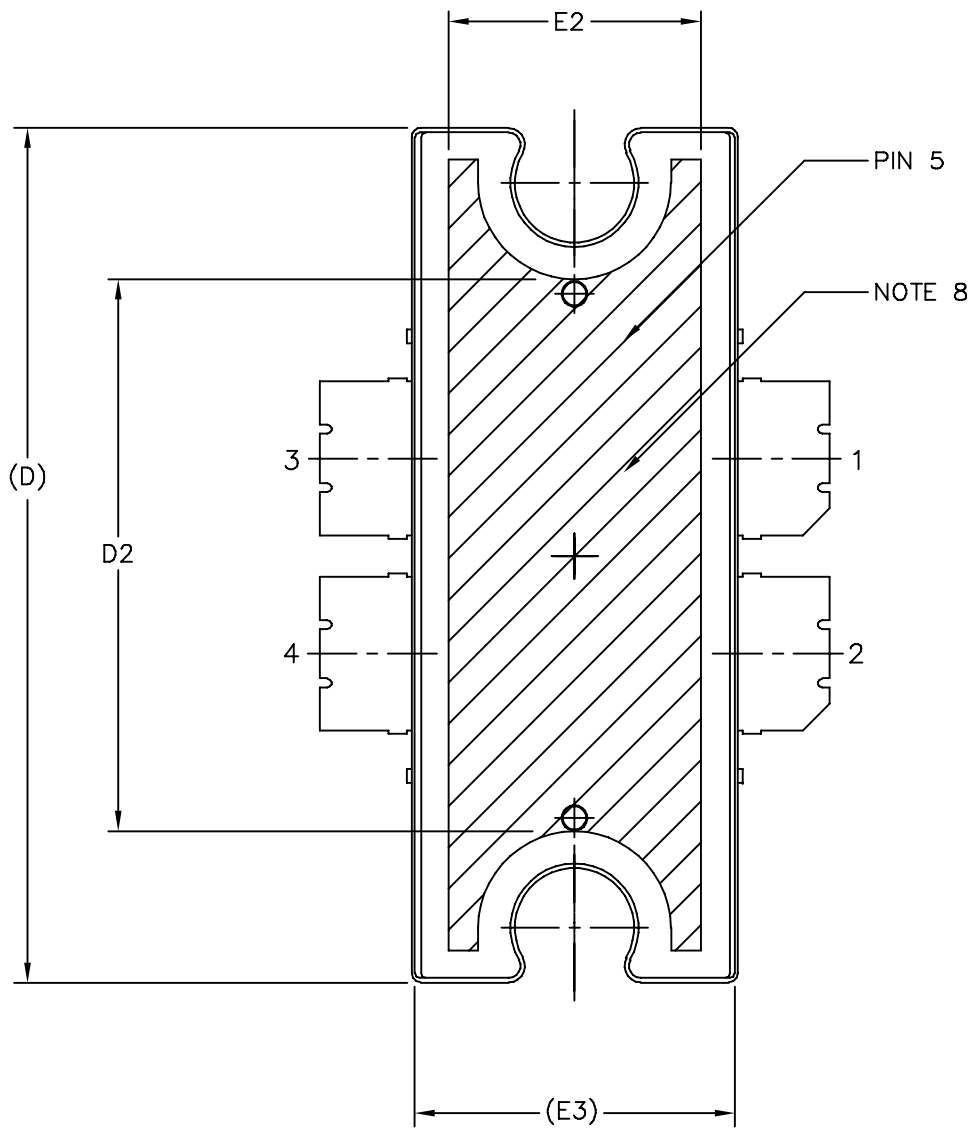

© FREESCALE SEMICONDUCTOR, INC. ALL RIGHTS RESERVED.	<b>MECHANICAL OUTLINE</b>	PRINT VERSION NOT TO SCALE	
TITLE: TO-272 4 LEAD, WIDE BODY	DOCUMENT NO: 98ASA10575D	REV: D	
	CASE NUMBER: 1484-04	05 APR 2006	
	STANDARD: NON-JEDEC		

NOTES:

1. CONTROLLING DIMENSION: INCH
2. INTERPRET DIMENSIONS AND TOLERANCES PER ASME Y14.5M-1994.
3. DATUM PLANE H IS LOCATED AT THE TOP OF LEAD AND IS COINCIDENT WITH THE LEAD WHERE THE LEAD EXITS THE PLASTIC BODY AT THE TOP OF THE PARTING LINE.
4. DIMENSIONS "D" AND "E1" DO NOT INCLUDE MOLD PROTRUSION. ALLOWABLE PROTRUSION IS .006 PER SIDE. DIMENSIONS "D" AND "E1" DO INCLUDE MOLD MISMATCH AND ARE DETERMINED AT DATUM PLANE H.
5. DIMENSIONS "b1" DOES NOT INCLUDE DAMBAR PROTRUSION. ALLOWABLE DAMBAR PROTRUSION SHALL BE .005 TOTAL IN EXCESS OF THE "b1" DIMENSION AT MAXIMUM MATERIAL CONDITION.
6. DATUM A AND B TO BE DETERMINED AT DATUM PLANE H.
7. DIMENSION A2 APPLIES WITHIN ZONE "J" ONLY.
8. HATCHING REPRESENTS EXPOSED AREA OF THE HEAT SLUG. HATCHED AREA SHOWN IS ON THE SAME PLANE.

STYLE 1:

PIN 1 - DRAIN      PIN 2 - DRAIN  
 PIN 3 - GATE        PIN 4 - GATE  
 PIN 5 - SOURCE

DIM	INCH		MILLIMETER		DIM	INCH		MILLIMETER	
	MIN	MAX	MIN	MAX		MIN	MAX	MIN	MAX
A	.100	.104	2.54	2.64	b1	.164	.170	4.17	4.32
A1	.039	.043	0.99	1.09	c1	.007	.011	.18	.28
A2	.040	.042	1.02	1.07	r1	.063	.068	1.60	1.73
D	.928	.932	23.57	23.67	e	.106 BSC		2.69 BSC	
D1	.810 BSC		20.57 BSC		e1	.239 INFO ONLY		6.07 INFO ONLY	
D2	.600	---	15.24	---	aaa	.004		.10	
E	.551	.559	14	14.2					
E1	.353	.357	8.97	9.07					
E2	.270	---	6.86	---					
E3	.346	.350	8.79	8.89					
F	.025 BSC		0.64 BSC						

© FREESCALE SEMICONDUCTOR, INC. ALL RIGHTS RESERVED.		<b>MECHANICAL OUTLINE</b>		PRINT VERSION NOT TO SCALE	
TITLE:  TO-272 4 LEAD WIDE BODY			DOCUMENT NO: 98ASA10575D		REV: D
			CASE NUMBER: 1484-04		05 APR 2006
			STANDARD: NON-JEDEC		

## PRODUCT DOCUMENTATION

Refer to the following documents to aid your design process.

### Application Notes

- AN1907: Solder Reflow Attach Method for High Power RF Devices in Plastic Packages
- AN1955: Thermal Measurement Methodology of RF Power Amplifiers
- AN3263: Bolt Down Mounting Method for High Power RF Transistors and RFICs in Over-Molded Plastic Packages

### Engineering Bulletins

- EB212: Using Data Sheet Impedances for RF LDMOS Devices

## REVISION HISTORY

The following table summarizes revisions to this document.

Revision	Date	Description
0	Jan. 2007	• Initial Release of Data Sheet

LIFETIME BUY

LAST ORDER 1 JUL 11 LAST SHIP 30 JUN 12

## **How to Reach Us:**

### **Home Page:**

[www.freescale.com](http://www.freescale.com)

### **Web Support:**

<http://www.freescale.com/support>

### **USA/Europe or Locations Not Listed:**

Freescale Semiconductor, Inc.  
 Technical Information Center, EL516  
 2100 East Elliot Road  
 Tempe, Arizona 85284  
 +1-800-521-6274 or +1-480-768-2130  
[www.freescale.com/support](http://www.freescale.com/support)

### **Europe, Middle East, and Africa:**

Freescale Halbleiter Deutschland GmbH  
 Technical Information Center  
 Schatzbogen 7  
 81829 Muenchen, Germany  
 +44 1296 380 456 (English)  
 +46 8 52200080 (English)  
 +49 89 92103 559 (German)  
 +33 1 69 35 48 48 (French)  
[www.freescale.com/support](http://www.freescale.com/support)

### **Japan:**

Freescale Semiconductor Japan Ltd.  
 Headquarters  
 ARCO Tower 15F  
 1-8-1, Shimo-Meguro, Meguro-ku,  
 Tokyo 153-0064  
 Japan  
 0120 191014 or +81 3 5437 9125  
[support.japan@freescale.com](mailto:support.japan@freescale.com)

### **Asia/Pacific:**

Freescale Semiconductor Hong Kong Ltd.  
 Technical Information Center  
 2 Dai King Street  
 Tai Po Industrial Estate  
 Tai Po, N.T., Hong Kong  
 +800 2666 8080  
[support.asia@freescale.com](mailto:support.asia@freescale.com)

### **For Literature Requests Only:**

Freescale Semiconductor Literature Distribution Center  
 P.O. Box 5405  
 Denver, Colorado 80217  
 1-800-441-2447 or 303-675-2140  
 Fax: 303-675-2150  
[LDCForFreescaleSemiconductor@hibbertgroup.com](mailto:LDCForFreescaleSemiconductor@hibbertgroup.com)

Information in this document is provided solely to enable system and software implementers to use Freescale Semiconductor products. There are no express or implied copyright licenses granted hereunder to design or fabricate any integrated circuits or integrated circuits based on the information in this document.

Freescale Semiconductor reserves the right to make changes without further notice to any products herein. Freescale Semiconductor makes no warranty, representation or guarantee regarding the suitability of its products for any particular purpose, nor does Freescale Semiconductor assume any liability arising out of the application or use of any product or circuit, and specifically disclaims any and all liability, including without limitation consequential or incidental damages. "Typical" parameters that may be provided in Freescale Semiconductor data sheets and/or specifications can and do vary in different applications and actual performance may vary over time. All operating parameters, including "Typicals", must be validated for each customer application by customer's technical experts. Freescale Semiconductor does not convey any license under its patent rights nor the rights of others. Freescale Semiconductor products are not designed, intended, or authorized for use as components in systems intended for surgical implant into the body, or other applications intended to support or sustain life, or for any other application in which the failure of the Freescale Semiconductor product could create a situation where personal injury or death may occur. Should Buyer purchase or use Freescale Semiconductor products for any such unintended or unauthorized application, Buyer shall indemnify and hold Freescale Semiconductor and its officers, employees, subsidiaries, affiliates, and distributors harmless against all claims, costs, damages, and expenses, and reasonable attorney fees arising out of, directly or indirectly, any claim of personal injury or death associated with such unintended or unauthorized use, even if such claim alleges that Freescale Semiconductor was negligent regarding the design or manufacture of the part.

Freescale™ and the Freescale logo are trademarks of Freescale Semiconductor, Inc. All other product or service names are the property of their respective owners.

© Freescale Semiconductor, Inc. 2007. All rights reserved.