

170183-1 ✓ ACTIVE

FASTON | FASTON 250

TE Internal #: 170183-1

Quick Disconnects, Receptacle, 22 – 18 AWG Wire Size, .32 – .82 mm² Wire Size, Mating Tab Width 6.35 mm [.25 in], Straight, Brass, FASTON 250

[View on TE.com >](#)



Terminals & Splices > Quick Disconnects



Quick Disconnect Terminal Type: **Receptacle**

Wire Size: .32 – .82 mm²

Mating Tab Width: 6.35 mm [.25 in]

Mating Tab Thickness: .81 mm [.032 in]

Features

Product Type Features

Insertion Force	Normal
-----------------	--------

Configuration Features

Connection Capacity	Single
Compatible With Wire & Cable Type	Discrete Wire

Contact Features

Quick Disconnect Terminal Type	Receptacle
Mating Tab Width	6.35 mm [.25 in]
Mating Tab Thickness	.81 mm [.032 in]
Terminal Orientation	Straight
Contact Base Material	Brass
Terminal Plating Material	Unplated
Crimp Type	F-Crimp
Barrel Type	Open

Termination Features

--	--



Product Terminates To	Wire & Cable
-----------------------	--------------

Mechanical Attachment

Extraction Force	24.5 Newton
------------------	-------------

Wire Insulation Support	With
-------------------------	------

Mating Retention Type	Dimple
-----------------------	--------

Dimensions

Terminal Material Thickness	.41 mm[.016 in]
-----------------------------	-----------------

Product Length	19 mm[.748 in]
----------------	----------------

Compatible Insulation Diameter Range	2.3 – 3.3 mm[.09 – .13 in]
--------------------------------------	----------------------------

Wire Size	.32 – .82 mm ²
-----------	---------------------------

Usage Conditions

Insulation Option	Uninsulated
-------------------	-------------

Operating Temperature Range	-40 – 110 °C[-40 – 230 °F]
-----------------------------	----------------------------

Industry Standards

Agency/Standard	CSA, UL
-----------------	---------

Packaging Features

Packaging Quantity	5000
--------------------	------

Packaging Method	Strip/Reel
------------------	------------

Other

Line	Premier
------	---------

Product Compliance

[For compliance documentation, visit the product page on TE.com>](#)

EU RoHS Directive 2011/65/EU	Compliant
------------------------------	-----------

EU ELV Directive 2000/53/EC	Compliant
-----------------------------	-----------

China RoHS 2 Directive MIIT Order No 32, 2016	No Restricted Materials Above Threshold
---	---

EU REACH Regulation (EC) No. 1907/2006	Current ECHA Candidate List: JUNE 2023 (235) Candidate List Declared Against: JAN 2023 (233) Does not contain REACH SVHC
--	--

Halogen Content	Low Halogen - Br, Cl, F, I < 900 ppm per homogenous material. Also BFR/CFR/PVC Free
-----------------	---

Solder Process Capability

Not applicable for solder process capability

Product Compliance Disclaimer

This information is provided based on reasonable inquiry of our suppliers and represents our current actual knowledge based on the information they provided. This information is subject to change. The part numbers that TE has identified as EU RoHS compliant have a maximum concentration of 0.1% by weight in homogenous materials for lead, hexavalent chromium, mercury, PBB, PBDE, DBP, BBP, DEHP, DIBP, and 0.01% for cadmium, or qualify for an exemption to these limits as defined in the Annexes of Directive 2011/65/EU (RoHS2). Finished electrical and electronic equipment products will be CE marked as required by Directive 2011/65/EU. Components may not be CE marked. Additionally, the part numbers that TE has identified as EU ELV compliant have a maximum concentration of 0.1% by weight in homogenous materials for lead, hexavalent chromium, and mercury, and 0.01% for cadmium, or qualify for an exemption to these limits as defined in the Annexes of Directive 2000/53/EC (ELV). Regarding the REACH Regulation, the information TE provides on SVHC in articles for this part number is based on the latest European Chemicals Agency (ECHA) 'Guidance on requirements for substances in articles' posted at this URL: <https://echa.europa.eu/guidance-documents/guidance-on-reach>

Compatible Parts



TE Part # 735209-2
250 FASTON REC 22-18 AWG TPBR



TE Part # 90166-1
DAHT 250 FASTON REC 22-18 ASSY



TE Part # 735209-1
250 FASTON REC 22-18 AWG BR



TE Part # 63648-1
250 FASTON FLAG REC 20-14 AWG BR



TE Part # 91514-1
CCII FASTON 250 REC 22-18 ASSY



TE Part # 170181-4
205 FASTON,REC.,22-18 AWG,BR



TE Part # 2-2150064-1
OCEAN_2.0_Applicator-E-090F130F



TE Part # 2-2150064-2
OCEAN_2.0_Applicator-E-090F130F



TE Part # 2150064-1
OCEAN_2.0_Applicator-E-090F130F



TE Part # 2150064-2
OCEAN_2.0_Applicator-E-090F130F



TE Part # 7-2150064-1
OCEAN_2.0_Applicator-E-090F130F



TE Part # 7-2150064-2
OCEAN_2.0_Applicator-E-090F130F



Also in the Series | **FASTON 250**

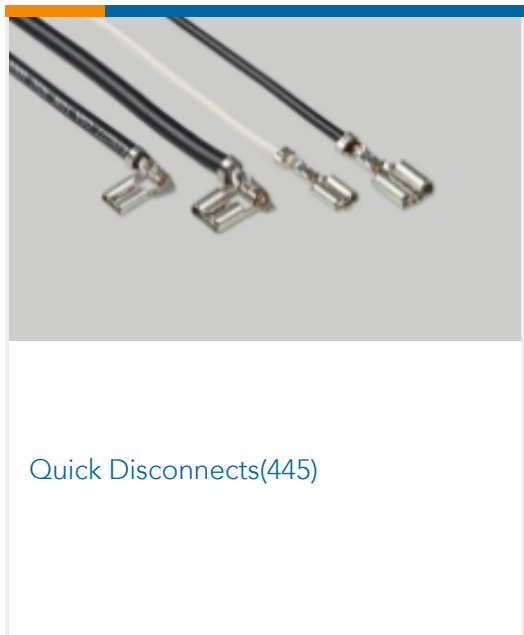
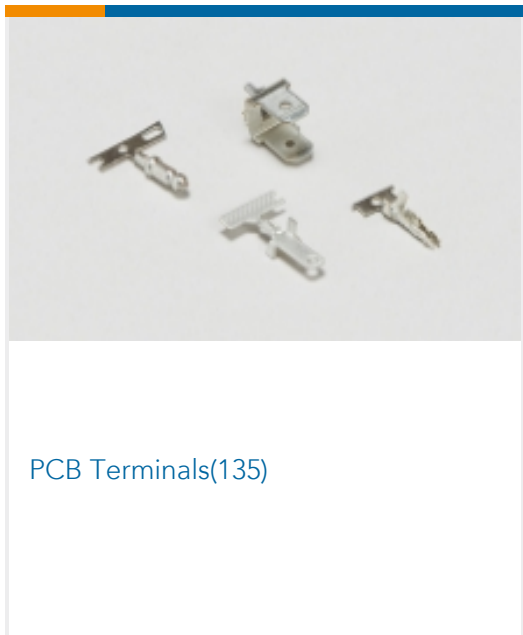
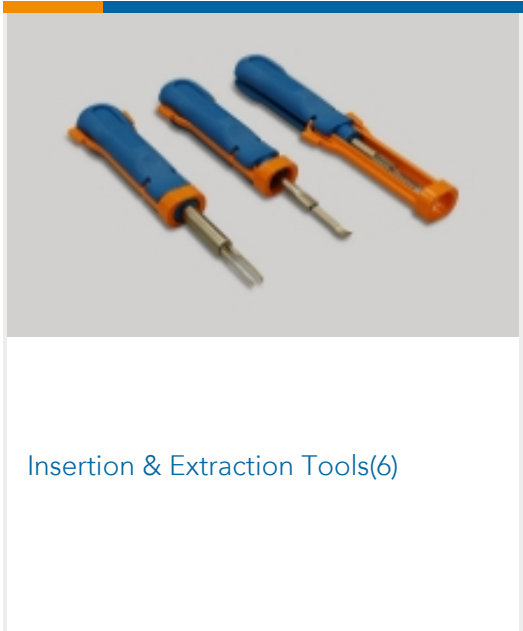
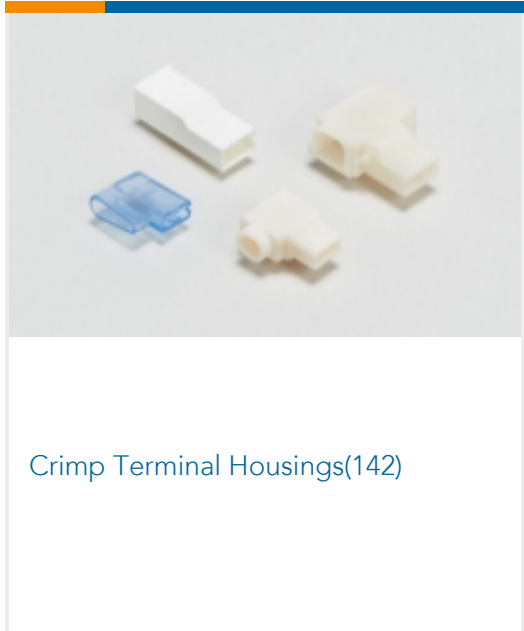
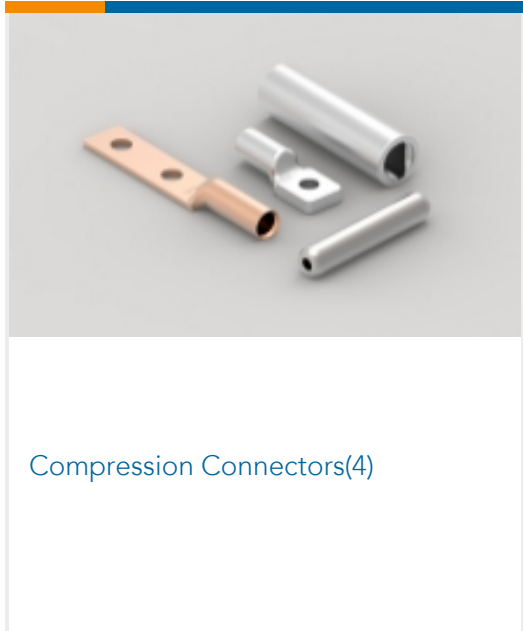

Customers Also Bought

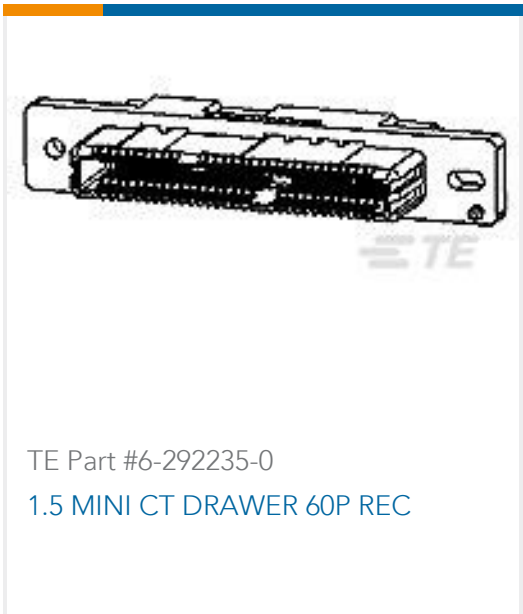

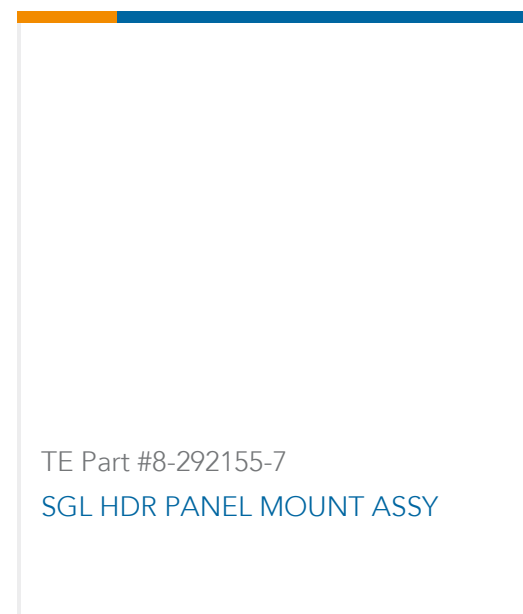

Documents

Product Drawings

250 FASTON,REC.,22-18 AWG,BR

English

CAD Files

3D PDF

3D

Customer View Model

ENG_CVM_CVM_170183-1_R.2d_dxf.zip

English

Customer View Model

ENG_CVM_CVM_170183-1_R.3d_igs.zip

English

Customer View Model

ENG_CVM_CVM_170183-1_R.3d_stp.zip

English

By downloading the CAD file I accept and agree to the [Terms and Conditions](#) of use.

Product Specifications

Application Specification

English

Application Specification

English

Product Environmental Compliance

MD_170183-1_09072016220_dmtec

English

MD_170183-1_09072016220_dmtec

English