

# PolarHV™ HiPerFET IXFC 30N60P Power MOSFET IXFR 30N60P

## Electrically Isolated Back Surface

N-Channel Enhancement Mode  
Fast Recovery Diode  
Avalanche Rated

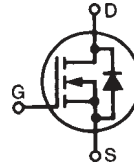

$$\begin{aligned} V_{DSS} &= 600 \text{ V} \\ I_{D25} &= 15 \text{ A} \\ R_{DS(on)} &\leq 250 \text{ m}\Omega \\ t_{rr} &\leq 250 \text{ ns} \end{aligned}$$

Symbol	Test Conditions	Maximum Ratings	
$V_{DSS}$	$T_J = 25^\circ\text{C}$ to $150^\circ\text{C}$	600	V
$V_{DGR}$	$T_J = 25^\circ\text{C}$ to $150^\circ\text{C}$ ; $R_{GS} = 1 \text{ M}\Omega$	600	V
$V_{GSS}$	Continuous	$\pm 30$	V
$V_{GSM}$	Transient	$\pm 40$	V
$I_{D25}$	$T_C = 25^\circ\text{C}$	15	A
$I_{DM}$	$T_C = 25^\circ\text{C}$ , pulse width limited by $T_{JM}$	80	A
$I_{AR}$	$T_C = 25^\circ\text{C}$	30	A
$E_{AR}$	$T_C = 25^\circ\text{C}$	50	mJ
$E_{AS}$	$T_C = 25^\circ\text{C}$	1.5	J
$dv/dt$	$I_S \leq I_{DM}$ , $di/dt \leq 100 \text{ A}/\mu\text{s}$ , $V_{DD} \leq V_{DSS}$ , $T_J \leq 150^\circ\text{C}$ , $R_G = 3 \Omega$	10	V/ns
$P_D$	$T_C = 25^\circ\text{C}$	166	W
$T_J$		-55 ... +150	$^\circ\text{C}$
$T_{JM}$		150	$^\circ\text{C}$
$T_{stg}$		-55 ... +150	$^\circ\text{C}$
$T_L$	1.6 mm (0.062 in.) from case for 10 s	300	$^\circ\text{C}$
$V_{ISOL}$	50/60 Hz, RMS, $t = 1$ minute, leads-to-tab	2500	V~
$F_C$	Mounting Force	(IXFC) 11..65 / 2.5..15 (IXFR) 20..120 / 4.5..25	N/lb N/lb
<b>Weight</b>	ISOPLUS220	2	g
	ISOPLUS247	5	g

ISOPLUS220™ (IXFC)  
E153432

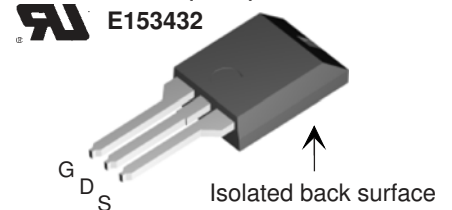

ISOPLUS247™ (IXFR)  
E153432

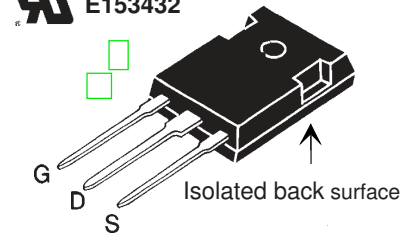

G = Gate  
S = Source

D = Drain

### Features

- Silicon chip on Direct-Copper-Bond substrate
- High power dissipation
- Isolated mounting surface
- 2500V electrical isolation
- Low drain to tab capacitance (<30pF)

### Applications

- DC-DC converters
- Battery chargers
- Switched-mode and resonant-mode power supplies
- DC choppers
- AC motor control

### Advantages

- Easy assembly
- Space savings
- High power density

Symbol	Test Conditions ( $T_J = 25^\circ\text{C}$ , unless otherwise specified)	Characteristic Values		
		Min.	Typ.	Max.
$BV_{DSS}$	$V_{GS} = 0 \text{ V}$ , $I_D = 250 \mu\text{A}$	600		V
$V_{GS(th)}$	$V_{DS} = V_{GS}$ , $I_D = 4 \text{ mA}$	3.0		5.0 V
$I_{GSS}$	$V_{GS} = \pm 30 \text{ V}$ , $V_{DS} = 0$			$\pm 100 \text{ nA}$
$I_{DSS}$	$V_{DS} = V_{DSS}$ $V_{GS} = 0 \text{ V}$ $T_J = 125^\circ\text{C}$			25 $\mu\text{A}$ 500 $\mu\text{A}$
$R_{DS(on)}$	$V_{GS} = 10 \text{ V}$ , $I_D = 15 \text{ A}$ Pulse test, $t \leq 300 \mu\text{s}$ , duty cycle $d \leq 2\%$			250 $\text{m}\Omega$

Symbol	Test Conditions	Characteristic Values		
		(T <sub>J</sub> = 25°C unless otherwise specified)		
		Min.	Typ.	Max.
<b>g<sub>fs</sub></b>	V <sub>DS</sub> = 20 V; I <sub>D</sub> = 15 A, pulse test	15	27	S
<b>C<sub>iss</sub></b>	V <sub>GS</sub> = 0 V, V <sub>DS</sub> = 25 V, f = 1 MHz		3820	pF
<b>C<sub>oss</sub></b>			360	pF
<b>C<sub>rss</sub></b>			28	pF
<b>t<sub>d(on)</sub></b>	V <sub>GS</sub> = 10 V, V <sub>DS</sub> = V <sub>DSS</sub> , I <sub>D</sub> = 15 A R <sub>G</sub> = 3 Ω (External)		22	ns
<b>t<sub>r</sub></b>			20	ns
<b>t<sub>d(off)</sub></b>			75	ns
<b>t<sub>f</sub></b>			25	ns
<b>Q<sub>g(on)</sub></b>	V <sub>GS</sub> = 10 V, V <sub>DS</sub> = 0.5 V <sub>DSS</sub> , I <sub>D</sub> = 15 A		85	nC
<b>Q<sub>gs</sub></b>			26	nC
<b>Q<sub>gd</sub></b>			28	nC
<b>R<sub>thJC</sub></b>			0.75	°C/W
<b>R<sub>thCS</sub></b>		0.21		°C/W

### Source-Drain Diode

Symbol	Test Conditions	Characteristic Values		
		(T <sub>J</sub> = 25°C unless otherwise specified)		
		Min.	Typ.	Max.
<b>I<sub>S</sub></b>	V <sub>GS</sub> = 0 V			30 A
<b>I<sub>SM</sub></b>	Repetitive			80 A
<b>V<sub>SD</sub></b>	I <sub>F</sub> = I <sub>S</sub> , V <sub>GS</sub> = 0 V, Pulse test, t ≤ 300 μs, duty cycle d ≤ 2 %			1.5 V
<b>t<sub>rr</sub></b>	I <sub>F</sub> = 25 A, -di/dt = 100 A/μs V <sub>R</sub> = 100 V; V <sub>GS</sub> = 0 V			200 ns
<b>I<sub>RM</sub></b>			8	A
<b>Q<sub>RM</sub></b>			0.6	μC

### ISOPLUS220 (IXFC) Outline

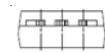
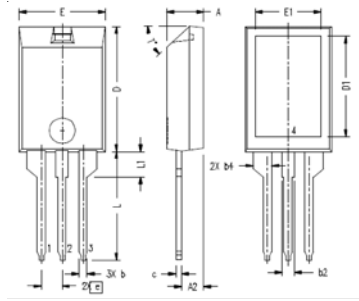

Note:  
Bottom heatsink (Pin 4) is electrically isolated from Pin 1, 2, or 3.

SYM	INCHES		MILLIMETERS	
	MIN	MAX	MIN	MAX
A	.157	.197	4.00	5.00
A2	.098	.118	2.50	3.00
b	.035	.051	0.90	1.30
b2	.049	.065	1.25	1.65
b4	.093	.100	2.35	2.55
c	.028	.039	0.70	1.00
D	.591	.630	15.00	16.00
D1	.472	.512	12.00	13.00
E	.394	.433	10.00	11.00
E1	.295	.335	7.50	8.50
e	.100 BASIC		2.55 BASIC	
L	.512	.571	13.00	14.50
L1	.118	.138	3.00	3.50
T*			42.5*	47.5*

IXYS CO 0177 R0

### ISOPLUS247 (IXFR) Outline

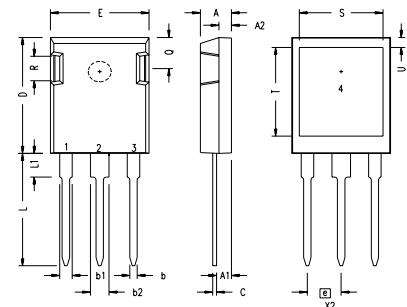

SYM	INCHES		MILLIMETERS	
	MIN	MAX	MIN	MAX
A	.190	.205	4.83	5.21
A1	.090	.100	2.29	2.54
A2	.075	.085	1.91	2.16
b	.045	.055	1.14	1.40
b1	.075	.084	1.91	2.13
b2	.115	.123	2.92	3.12
C	.024	.031	0.61	0.80
D	.819	.840	20.80	21.34
E	.620	.635	15.75	16.13
e	.215 BSC		5.45 BSC	
L	.780	.800	19.81	20.32
L1	.150	.170	3.81	4.32
Q	.220	.244	5.59	6.20
R	.170	.190	4.32	4.83
S	.520	.540	13.21	13.72
T	.620	.640	15.75	16.26
U	.065	.080	1.65	2.03

- 1 - GATE
- 2 - DRAIN (COLLECTOR)
- 3 - SOURCE (EMITTER)
- 4 - NO CONNECTION

NOTE: This drawing will meet all dimensions requirement of JEDEC outline TO-247AD except screw hole.

IXYS reserves the right to change limits, test conditions, and dimensions.

IXYS MOSFETs and IGBTs are covered by	4,835,592	4,931,844	5,049,961	5,237,481	6,162,665	6,404,065 B1	6,683,344	6,727,585
one or more of the following U.S. patents:	4,850,072	5,017,508	5,063,307	5,381,025	6,259,123 B1	6,534,343	6,710,405 B2	6,759,692
	4,881,106	5,034,796	5,187,117	5,486,715	6,306,728 B1	6,583,505	6,710,463	6,771,478 B2

**Fig. 1. Output Characteristics**  
@ 25°C

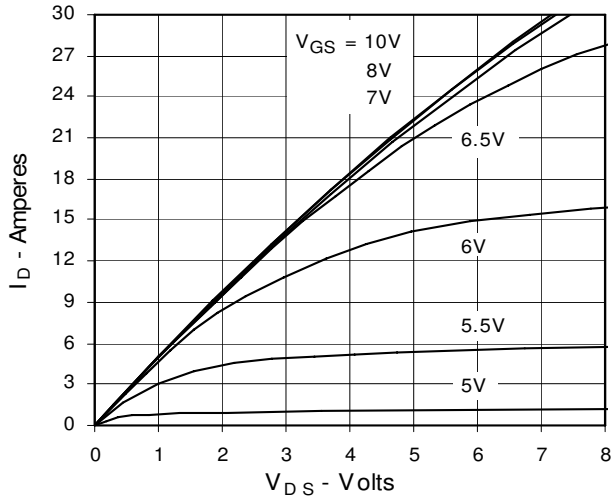

**Fig. 2. Extended Output Characteristics**  
@ 25°C

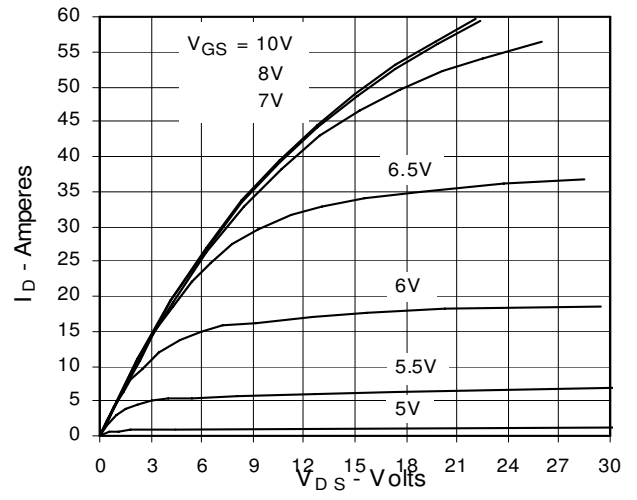

**Fig. 3. Output Characteristics**  
@ 125°C

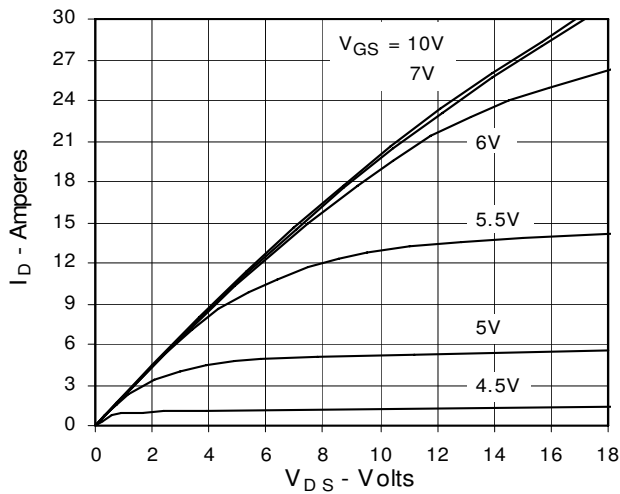

**Fig. 4.  $R_{DS(on)}$  Normalized to  $I_D = 15A$  Value vs. Junction Temperature**

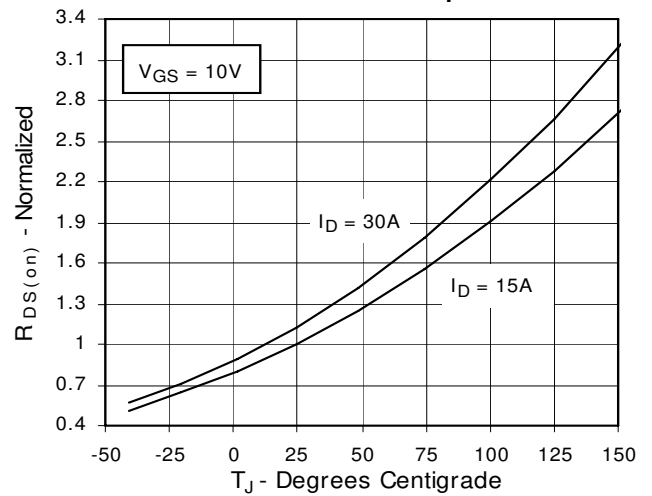

**Fig. 5.  $R_{DS(on)}$  Normalized to  $I_D = 15A$  Value vs. Drain Current**

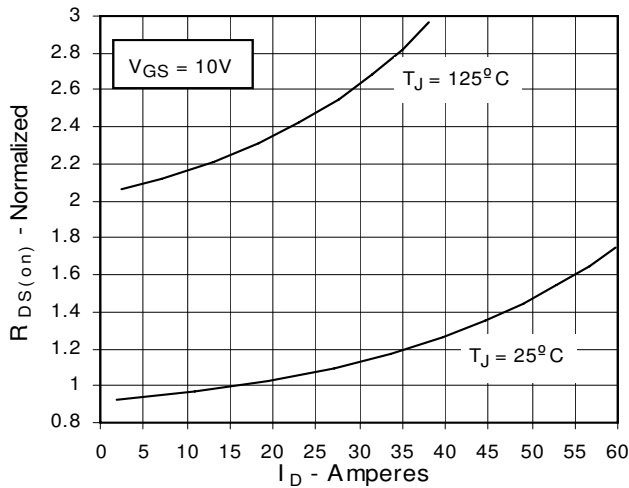

**Fig. 6. Drain Current vs. Case Temperature**

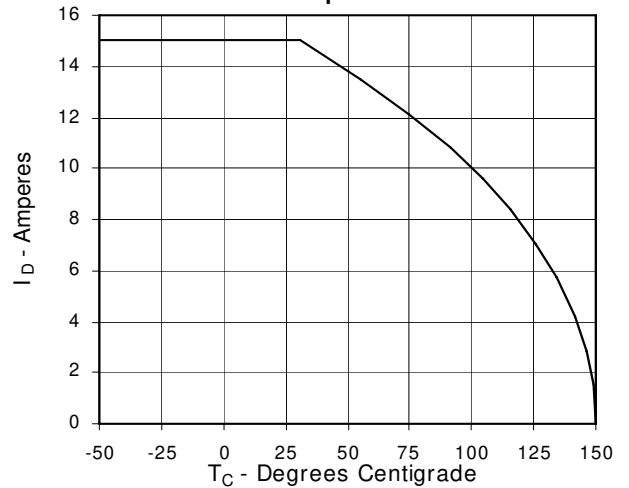

**Fig. 7. Input Admittance**

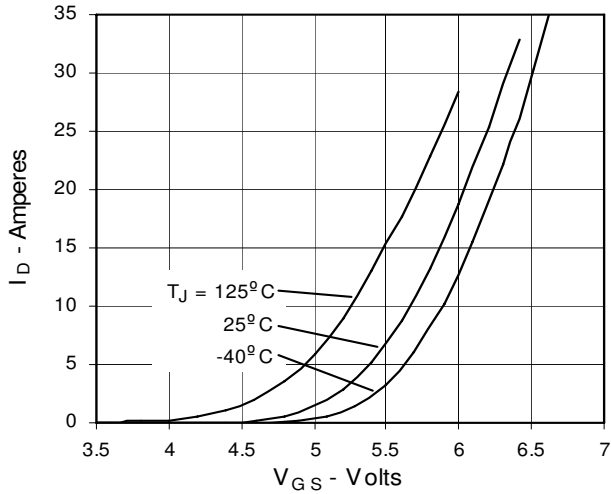

**Fig. 8. Transconductance**

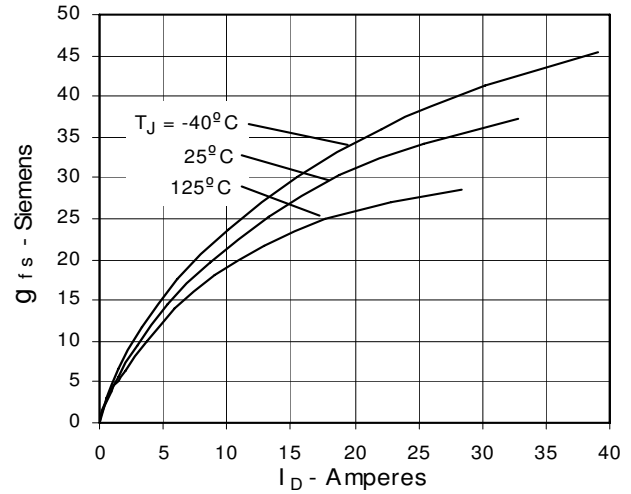

**Fig. 9. Source Current vs. Source-To-Drain Voltage**

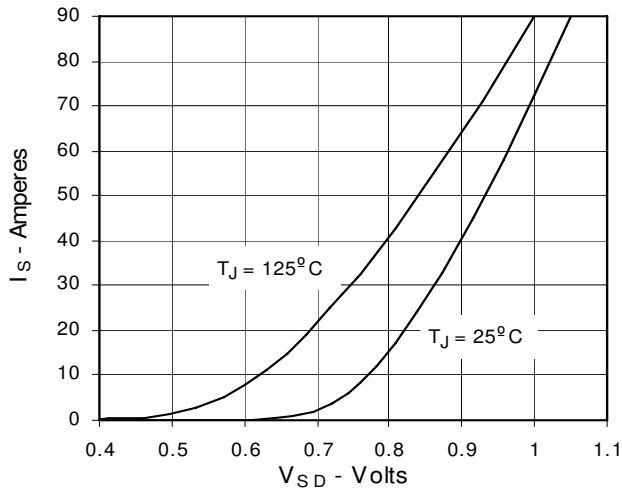

**Fig. 10. Gate Charge**

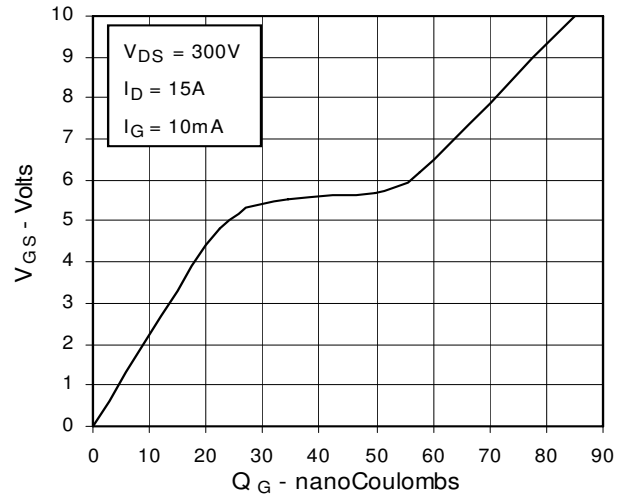

**Fig. 11. Capacitance**

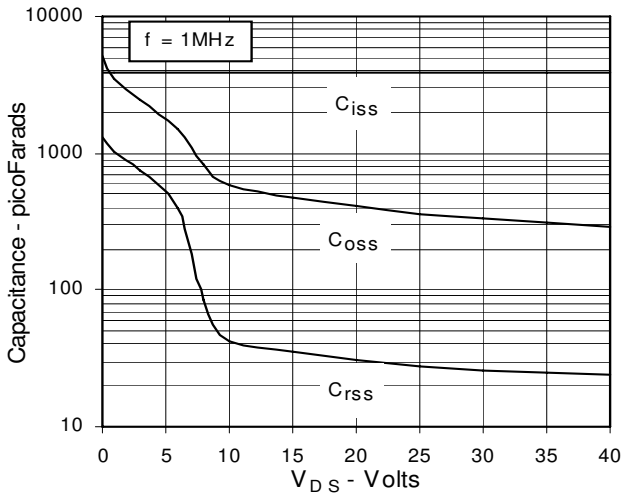

**Fig. 12. Maximum Transient Thermal Resistance**

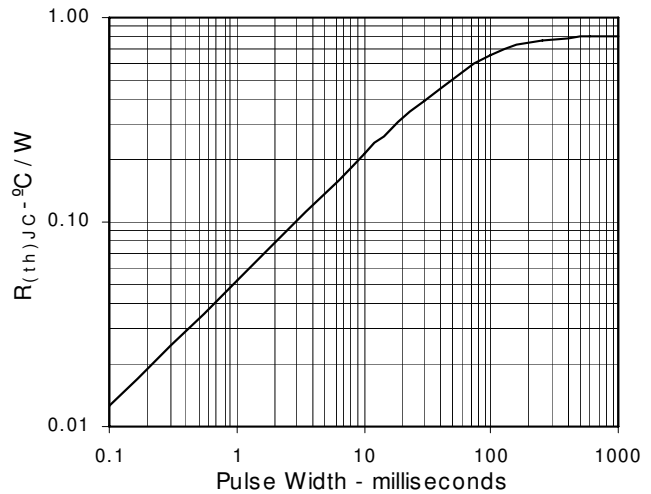



---

Disclaimer Notice - Information furnished is believed to be accurate and reliable. However, users should independently evaluate the suitability of and test each product selected for their own applications. Littelfuse products are not designed for, and may not be used in, all applications. Read complete Disclaimer Notice at [www.littelfuse.com/disclaimer-electronics](http://www.littelfuse.com/disclaimer-electronics).