

PKM4613NH Fully regulated DC-DC Converters
 Input 36-75 V, Output up to 50 A / 600 W

28701-BMR669 07 Rev G

June 2023

© Flex

Key Features

- Industry standard Quarter-brick
 57.9 x 36.8 x 11.4 mm (2.28 x 1.45 x 0.45 inch)
- Telecom standard input range 36-75 Vin
- Deliver up to 600W maximum output power
- Fully tightly regulated output voltage
- High efficiency, typical 96.2 % at 50% load
- 2250V input to output functional isolation
- 1500V basic insulation
- Wide operating temperature range -30°C to 90°C
- Input overvoltage suppression
- Soft-start for handling of high capacitance loads
- More than 3.34 million hours MTBF



General Characteristics

- Optional baseplate
- Optional single output pins
- Hiccup OCP, OTP, OVP and under voltage lockout

Safety Approvals



Design for Environment



Meets requirements in high-temperature lead-free soldering processes.

Contents

Ordering Information	2
General Information	2
Safety Specification	3
Absolute Maximum Ratings	4
Electrical Specification	
12 V, 50 A / 600 W	PKM 4613 NH PI 5
EMC Specification	11
Operating Information	12
Thermal Consideration	16
Connections	18
Mechanical Information	19
Soldering Information	22
Delivery Information	22
Product Qualification Specification	26

Technical Specification

PKM4613NH Fully regulated DC-DC Converters
Input 36-75 V, Output up to 50 A / 600 W

28701-BMR669 07 Rev G

June 2023

© Flex

Ordering Information

Product program	Output
PKM 4613NH PI	12 V @ 50 A

Product number and Packaging

PKM 4613NH n ₁ n ₂ n ₃ n ₄ n ₅					
Options	n ₁	n ₂	n ₃	n ₄	n ₅
Mounting option	o				
Baseplate		o			
Power pinning			o		
Lead length				o	
Delivery package					o

Options	Description
n ₁	PI Through hole
n ₂	Open frame* HS Baseplate
n ₃	Double power pin* SP Single power pin
n ₄	5.33 mm* LA 3.69 mm LB 4.57 mm LC 2.79 mm
n ₅	* Default as Foam tray, support wave soldering 1 Dry pack soft tray, support pin in paste 2 Dry pack hard tray, support pin in paste

* Standard variant (i.e. no option selected).
For example, the through hole version product with baseplate, single power pin with short lead length is PKM4613NHPIHSSPLA.

General Information

Reliability

The failure rate (λ) and mean time between failures (MTBF = $1/\lambda$) is calculated at max output power and an operating ambient temperature (T_A) of +40°C. Flex Power Modules uses Telcordia SR-332 Issue 2 Method 1 to calculate the mean steady-state failure rate and standard deviation (σ).

Telcordia SR-332 Issue 2 also provides techniques to estimate the upper confidence levels of failure rates based on the mean and standard deviation.

Mean steady-state failure	Std. deviation, σ
299 nFailures/h	36 nFailures/h

MTBF (mean value) for the PKM-NH series = 3.34 Mh.
MTBF at 90% confidence level = 2.89 Mh

Compatibility with RoHS requirements

The products are compatible with the relevant clauses and requirements of the RoHS directive 2011/65/EU and 2015/863 and have a maximum concentration value of 0.1% by weight in homogeneous materials for lead, mercury, hexavalent chromium, PBB, PBDE, DEHP, BBP, DBP, DIBP and of 0.01% by weight in homogeneous materials for cadmium.

Exemptions in the RoHS directive utilized in Flex Power products are found in the Statement of Compliance document.

Flex Power fulfills and will continuously fulfill all its obligations under regulation (EC) No 1907/2006 concerning the registration, evaluation, authorization and restriction of chemicals (REACH) as they enter into force and is through product materials declarations preparing for the obligations to communicate information on substances in the products.

Quality Statement

The products are designed and manufactured in an industrial environment where quality systems and methods like ISO 9000, Six Sigma, and SPC are intensively in use to boost the continuous improvements strategy. Infant mortality or early failures in the products are screened out and they are subjected to an ATE-based final test. Conservative design rules, design reviews and product qualifications, plus the high competence of an engaged work force, contribute to the high quality of the products.

Warranty

Warranty period and conditions are defined in Flex Power General Terms and Conditions of Sale.

Limitation of Liability

Flex Power does not make any other warranties, expressed or implied including any warranty of merchantability or fitness for a particular purpose (including, but not limited to, use in life support applications, where malfunctions of product can cause injury to a person's health or life).

© Flex 2023

The information and specifications in this technical specification is believed to be correct at the time of publication. However, no liability is accepted for inaccuracies, printing errors or for any consequences thereof. Flex Power reserves the right to change the contents of this technical specification at any time without prior notice.

Technical Specification

PKM4613NH Fully regulated DC-DC Converters Input 36-75 V, Output up to 50 A / 600 W	28701-BMR669 07 Rev G	June 2023
	© Flex	

Safety Specification**General information**

Flex Power DC/DC converters and DC/DC regulators are designed in accordance with the safety standards IEC 62368-1, EN 62368-1 and UL 62368-1 *Audio/video, information and communication technology equipment - Part 1: Safety requirements*

IEC/EN/UL 62368-1 contains requirements to prevent injury or damage due to the following hazards:

- Electrical shock
- Electrically-caused fire
- Injury caused by hazardous substances
- Mechanically-caused injury
- Skin burn
- Radiation-caused injury

On-board DC/DC converters, Power interface modules and DC/DC regulators are defined as component power supplies. As components they cannot fully comply with the provisions of any safety requirements without "conditions of acceptability". Clearance between conductors and between conductive parts of the component power supply and conductors on the board in the final product must meet the applicable safety requirements. Certain conditions of acceptability apply for component power supplies with limited stand-off (see Mechanical Information for further information). It is the responsibility of the installer to ensure that the final product housing these components complies with the requirements of all applicable safety standards and regulations for the final product.

Component power supplies for general use shall comply with the requirements in IEC/EN/UL 62368-1. Product related standards, e.g. IEEE 802.3af *Power over Ethernet*, and ETS-300132-2 *Power interface at the input to telecom equipment, operated by direct current (dc)* are based on IEC/EN/UL 60950-1 with regards to safety.

Flex Power DC/DC converters, Power interface modules and DC/DC regulators are UL 62368-1 recognized and certified in accordance with EN 62368-1. The flammability rating for all construction parts of the products meet requirements for V-0 class material according to IEC 60695-11-10, *Fire hazard testing, test flames – 50 W* horizontal and vertical flame test methods.

Isolated DC/DC converters

The product may provide basic or functional insulation between input and output according to IEC/EN/UL 62368-1 (see Safety Certificate), different conditions shall be met if the output of a basic or a functional insulated product shall be considered as ES1 energy source.

For basic insulated products (see Safety Certificate) the output is considered as ES1 energy source if one of the

following conditions is met:

- The input source provides supplementary or double or reinforced insulation from the AC mains according to IEC/EN/UL 62368-1.
- The input source provides functional or basic insulation from the AC mains and the product's output is reliably connected to protective earth according to IEC/EN/UL 62368-1.

For functional insulated products (see Safety Certificate) the output is considered as ES1 energy source if one of the following conditions is met:

- The input source provides double or reinforced insulation from the AC mains according to IEC/EN/UL 62368-1.
- The input source provides basic or supplementary insulation from the AC mains and the product's output is reliably connected to protective earth according to IEC/EN/UL 62368-1.
- The input source is reliably connected to protective earth and provides basic or supplementary insulation according to IEC/EN/UL 62368-1 and the maximum input source voltage is 60 Vdc.

Galvanic isolation between input and output is verified in an electric strength test and the isolation voltage (V_{iso}) meets the voltage strength requirement for basic insulation according to IEC/EN/UL 62368-1.

It is recommended to use a slow blow fuse at the input of each DC/DC converter. If an input filter is used in the circuit the fuse should be placed in front of the input filter. In the rare event of a component problem that imposes a short circuit on the input source, this fuse will provide the following functions:

- Isolate the fault from the input power source so as not to affect the operation of other parts of the system
- Protect the distribution wiring from excessive current and power loss thus preventing hazardous overheating

Technical Specification

PKM4613NH Fully regulated DC-DC Converters
 Input 36-75 V, Output up to 50 A / 600 W

28701-BMR669 07 Rev G June 2023

© Flex

Absolute Maximum Ratings

Characteristics		min	typ	max	Unit
T_{P1}	Operating Temperature (see Thermal Consideration section)	-40		+125	°C
T_S	Storage temperature	-55		+125	°C
V_I	Input voltage	-0.5		+80	V
C_{out}	Output capacitance	470			µF
C_{out_ESR}	Output capacitance ESR	10		80	mOhm
V_{iso}	Isolation voltage (input to output qualification test voltage)			2250	Vdc
V_{iso}	Isolation voltage (input to baseplate qualification test voltage)			1500	Vdc
V_{iso}	Isolation voltage (baseplate to output qualification test voltage)			750	Vdc
V_{tr}	Input voltage transient, according to ETSI EN 300 132-2 and Telcordia GR-1089-CORE			100	V
V_{RC}	Remote Control pin voltage (see Operating Information section)	Positive logic option		6	V
		Negative logic option	-0.5		6

Stress in excess of Absolute Maximum Ratings may cause permanent damage. Absolute Maximum Ratings, sometimes referred to as no destruction limits, are normally tested with one parameter at a time exceeding the limits in the Electrical Specification. If exposed to stress above these limits, function and performance may degrade in an unspecified manner.

Fundamental Circuit Diagram

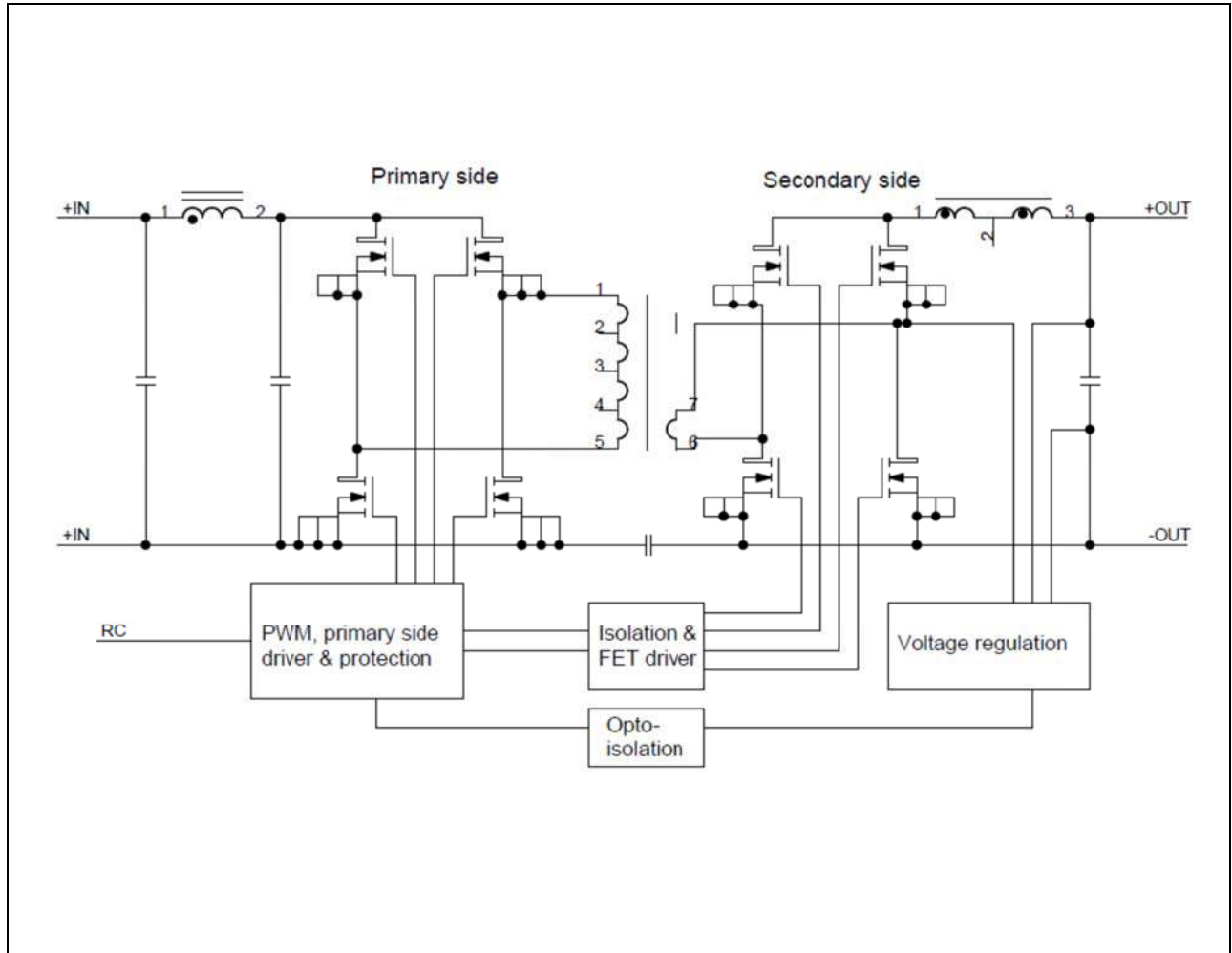

Technical Specification

PKM4613NH Fully regulated DC-DC Converters
Input 36-75 V, Output up to 50 A / 600 W

28701-BMR669 07 Rev G

June 2023

© Flex

Electrical Specification
12 V, 50 A / 600 W

PKM 4613NH PI

$T_{P1} = -30$ to $+90^{\circ}\text{C}$, $V_I = 36$ to 75 V, unless otherwise specified under Conditions.

Typical values given at: $T_{P1} = +25^{\circ}\text{C}$, $V_I = 53$ V, $I_O = \text{max}$, unless otherwise specified under Conditions.

Additional $C_{in} = 470$ μF , $C_{out} = 2200$ μF . See Operating Information section for selection of capacitor types.

Characteristics		Conditions	min	typ	max	Unit
V_I	Input voltage range		36		75	V
V_{loff}	Turn-off input voltage	Decreasing input voltage	29	31	33	V
V_{lon}	Turn-on input voltage	Increasing input voltage	32	34	36	V
C_I	Internal input capacitance	$V_I = 53$ V		15		μF
P_O	Output power	$V_I = 43-75$ V	0		600	W
η	Efficiency	50% of max I_O		96.2		%
		max I_O		96.2		
		50% of max I_O , $V_I = 48$ V		96.5		
		max I_O , $V_I = 48$ V		96.3		
P_d	Power Dissipation	max I_O		24		W
P_{II}	Input idling power	$I_O = 0$ A, $V_I = 53$ V		6.8		W
P_{RC}	Input standby power	$V_I = 53$ V (turned off with RC)		0.3		W
f_s	Switching frequency (Ripple f_s)	0-100 % of max I_O	375	400	425	kHz

V_{OI}	Output voltage initial setting	$T_{P1} = +25^{\circ}\text{C}$, $V_I = 53$ V, $I_O = 50$ A		12		V
	Output voltage tolerance band	0-100% of max I_O , $V_I = 43-75$ V	11.64		12.36	V
	Input to output voltage ratio, V_{in}/V_{out}	$T_{P1} = +25^{\circ}\text{C}$, 0-100% of max I_O , $V_I = 36-42$ V	3.41	3.51	3.61	
	Idling voltage	$I_O = 0$ A		12		V
	Line regulation	max I_O , $V_I = 43-75$ V		3	30	mV
	Load regulation	$V_I = 53$ V, 0-100% of max I_O		3	15	mV
V_{tr}	Load transient voltage deviation	$V_I = 53$ V, Load step 25-75-25% of max I_O , $di/dt = 1$ A/ μs		± 250	350	mV
t_{tr}	Load transient recovery time			100		μs
t_r	Ramp-up time (from 10-90% of V_{OI})	0-100% of max I_O		5	9	ms
t_s	Start-up time (from V_I connection to 90% of V_{OI})			6	10	ms
t_f	V_I shut-down fall time (from V_I off to 10% of V_O)	max I_O		2		ms
		$I_O = 0$ A		165		s
t_{RC}	RC start-up time	max I_O		6		ms
	RC shut-down fall time (from RC off to 10% of V_O)	max I_O		2		ms
		$I_O = 0$ A		200		s
I_O	Output current		0		50	A
I_{lim}	Current limit threshold	$T_{P1} < \text{max } T_{P1}$		65		A
I_{sc}	Short circuit current	$T_{P1} = 25^{\circ}\text{C}$		7		A
C_{out}	Recommended Capacitive Load, See Note 1	$T_{P1} = -30^{\circ}\text{C} - 90^{\circ}\text{C}$	2200		15000	μF
C_{out}	Recommended Capacitive Load, See Note 2	$T_{P1} = -10^{\circ}\text{C} - 90^{\circ}\text{C}$	470		15000	μF
C_{out_ESR}	See Note 3		10		80	m Ω
V_{Oac}	Output ripple & noise	See ripple & noise section, V_{OI}		200	500	mVp-p
OVP _{in}	Input Overvoltage Protection	0-100% of max I_O	100	105		V
OVP	Over voltage protection			14.5		V
RC	Sink current	See operating information	0.5			mA
	Source current	RC pin connected to -IN			0.51	mA
	Trigger level	See operating information	1	2		V
	Response time				0.5	ms

Technical Specification

PKM4613NH Fully regulated DC-DC Converters
Input 36-75 V, Output up to 50 A / 600 W

28701-BMR669 07 Rev G

June 2023

© Flex

Note 1: Restrictions in start up current at high output capacitance, see graph "Maximum start-up current vs. Output capacitance". The module shall not be used without input and output capacitors.
 Note 2: May lead to OVP during start-up under -10C degree. The module shall not be used without input and output capacitors.
 Note 3: ESR is highly temperature dependent for some types of capacitors e.g. aluminum electrolyte capacitors will freeze in cold environment.

Typical Characteristics
12 V, 50 A / 600 W

PKM 4613NH PI

Efficiency

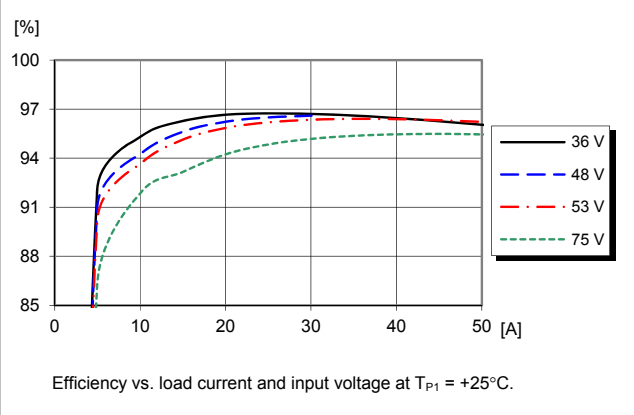

Power Dissipation

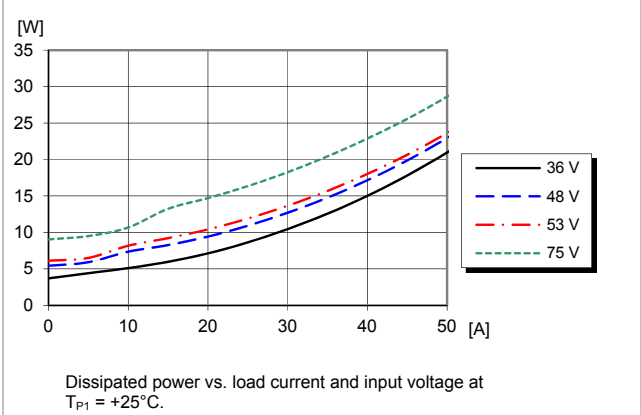

Output Characteristics

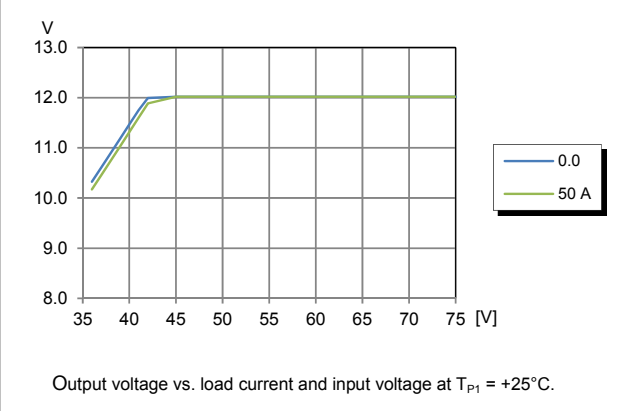

Output Characteristics, $V_I = 36 - 43\text{V}$

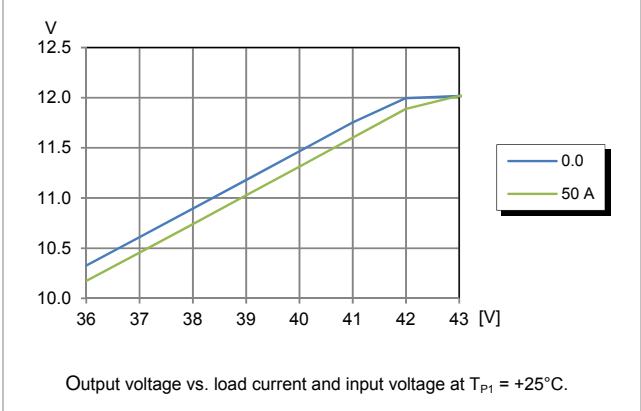

Current Limit Characteristics

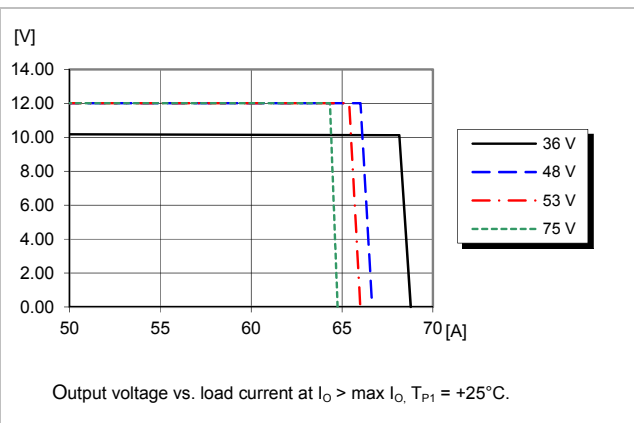

Available Power

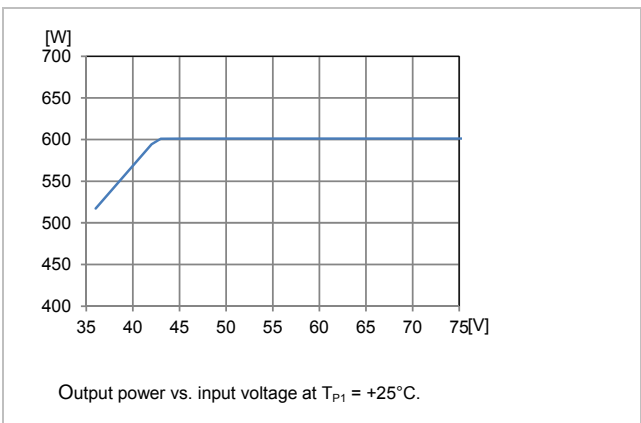

Technical Specification

PKM4613NH Fully regulated DC-DC Converters
 Input 36-75 V, Output up to 50 A / 600 W

28701-BMR669 07 Rev G

June 2023

© Flex

Typical Characteristics
 12 V, 50 A / 600 W

PKM 4613NH PI

Start-up

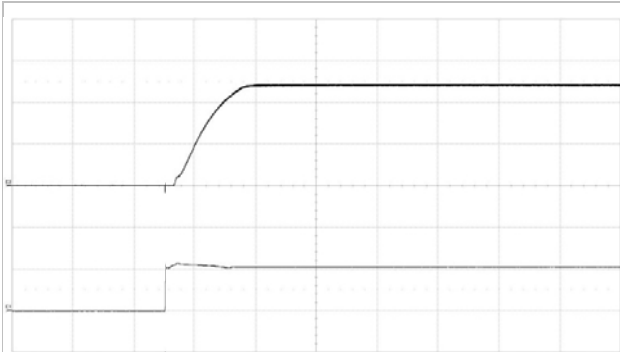

Start-up enabled by connecting V_I at:
 $T_{P1} = +25^\circ\text{C}$, $V_I = 53\text{ V}$, $C_{out} = 2.2\text{ mF}$
 $I_O = 50\text{ A}$ resistive load.

Top trace: output voltage (5 V/div.).
 Bottom trace: input voltage (50 V/div.).
 Time scale: (5 ms/div.).

Shut-down

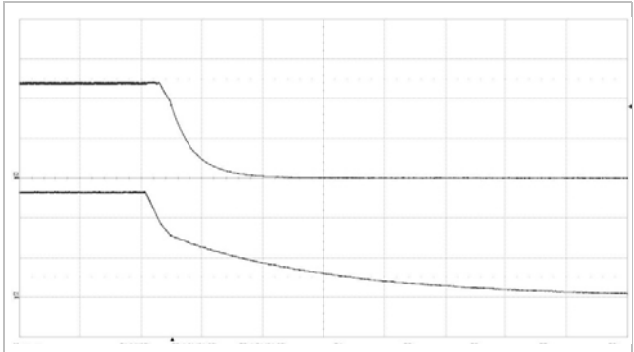

Shut-down enabled by disconnecting V_I at:
 $T_{P1} = +25^\circ\text{C}$, $V_I = 53\text{ V}$, $C_{out} = 2.2\text{ mF}$
 $I_O = 50\text{ A}$ resistive load.

Top trace: output voltage (5 V/div.).
 Bottom trace: input voltage (20 V/div.).
 Time scale: (2 ms/div.).

Output Ripple & Noise

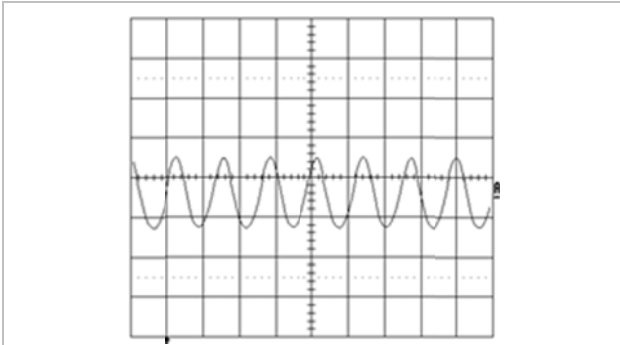

Output voltage ripple at:
 $T_{P1} = +25^\circ\text{C}$, $V_I = 53\text{ V}$, $C_{out} = 2.2\text{ mF}$
 $I_O = 50\text{ A}$ resistive load.

Trace: output voltage (100 mV/div.).
 Time scale: (2 μs/div.).

Output Load Transient Response



Output voltage response to load current step-change (12.5-37.5-12.5 A) at:
 $T_{P1} = +25^\circ\text{C}$, $V_I = 53\text{ V}$, $C_{out} = 2.2\text{ mF}$

Top trace: output voltage (500 mV/div.).
 Bottom trace: load current (20 A/div.).
 Time scale: (0.2 ms/div.).

Maximum start-up current vs. Output capacitance

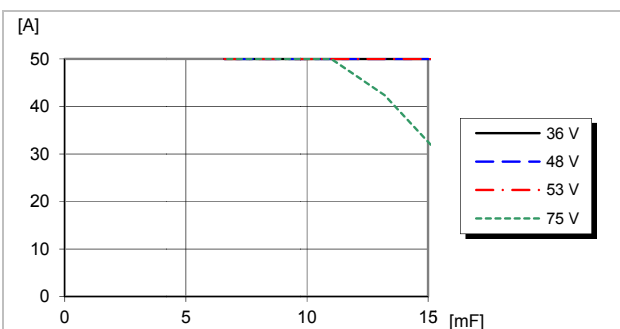

Maximum start-up current vs output capacitance with resistive load at
 $T_{P1} = +25^\circ\text{C}$

Technical Specification

PKM4613NH Fully regulated DC-DC Converters
 Input 36-75 V, Output up to 50 A / 600 W

28701-BMR669 07 Rev G

June 2023

© Flex

Start up in cold

Vin 36V, -30°C

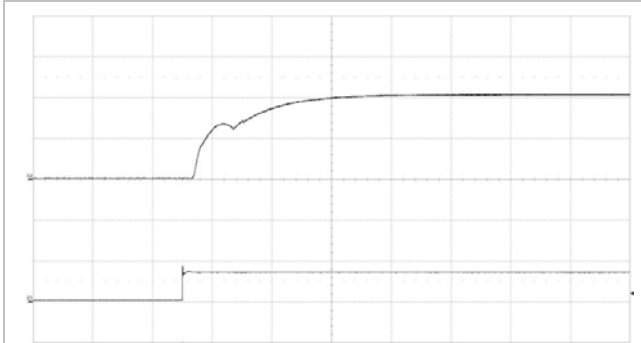

Start-up enabled by connecting V_I at:
 $T_{P1} = -30^\circ\text{C}$, $V_I = 36\text{ V}$, $C_{out} = 2.2\text{mF}$
 $I_O = 0\text{ A}$.

Top trace: output voltage (5 V/div.).
 Bottom trace: input voltage (50 V/div.).
 Time scale: (5 ms/div.).

PKM 4613NH PI

Vin 36V, -10°C

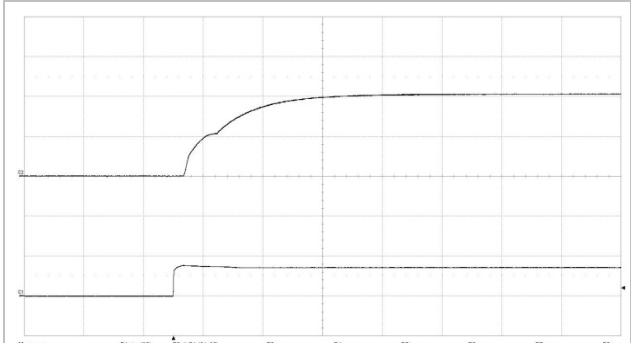

Start-up enabled by connecting V_I at:
 $T_{P1} = -10^\circ\text{C}$, $V_I = 36\text{ V}$, $C_{out} = 2.2\text{mF}$
 $I_O = 0\text{ A}$.

Top trace: output voltage (5 V/div.).
 Bottom trace: input voltage (50 V/div.).
 Time scale: (5 ms/div.).

Vin 53V, -30°C

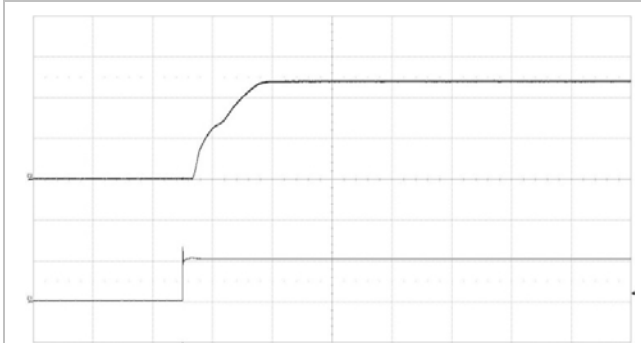

Start-up enabled by connecting V_I at:
 $T_{P1} = -30^\circ\text{C}$, $V_I = 53\text{ V}$, $C_{out} = 2.2\text{mF}$
 $I_O = 0\text{ A}$.

Top trace: output voltage (5 V/div.).
 Bottom trace: input voltage (50 V/div.).
 Time scale: (5 ms/div.).

Vin 53V, -10°C

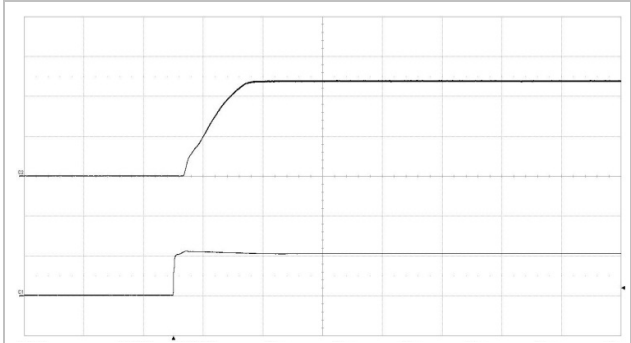

Start-up enabled by connecting V_I at:
 $T_{P1} = -10^\circ\text{C}$, $V_I = 53\text{ V}$, $C_{out} = 2.2\text{mF}$
 $I_O = 0\text{ A}$.

Top trace: output voltage (5 V/div.).
 Bottom trace: input voltage (50 V/div.).
 Time scale: (5 ms/div.).

Vin 75V, -30°C

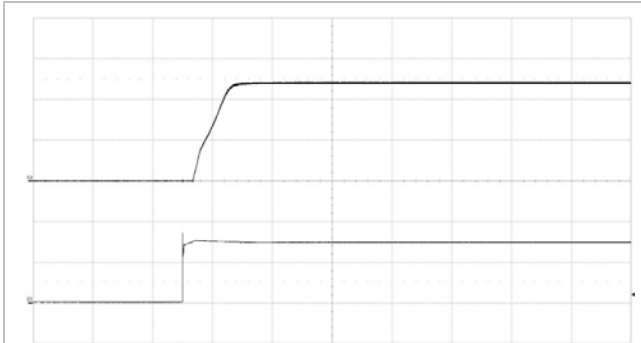

Start-up enabled by connecting V_I at:
 $T_{P1} = -30^\circ\text{C}$, $V_I = 75\text{ V}$, $C_{out} = 2.2\text{mF}$
 $I_O = 0\text{ A}$.

Top trace: output voltage (5 V/div.).
 Bottom trace: input voltage (50 V/div.).
 Time scale: (5 ms/div.).

Vin 75V, -10°C

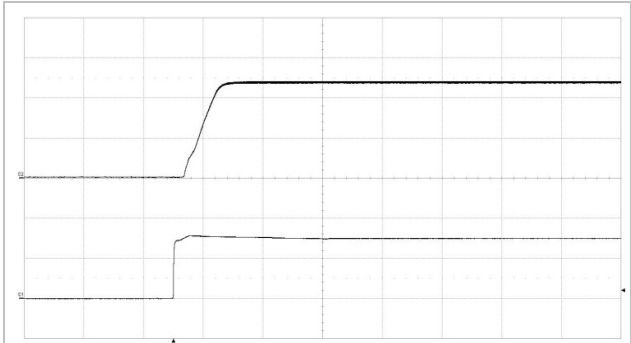

Start-up enabled by connecting V_I at:
 $T_{P1} = -10^\circ\text{C}$, $V_I = 75\text{ V}$, $C_{out} = 2.2\text{mF}$
 $I_O = 0\text{ A}$.

Top trace: output voltage (5 V/div.).
 Bottom trace: input voltage (50 V/div.).
 Time scale: (5 ms/div.).

PKM4613NH Fully regulated DC-DC Converters
 Input 36-75 V, Output up to 50 A / 600 W

28701-BMR669 07 Rev G

June 2023

© Flex

Typical Characteristics
 12 V, 50 A / 600 W

PKM 4613NH PI

Output Power Derating – Single pin and base plate
 (PKM4613 NH PI HS SP)

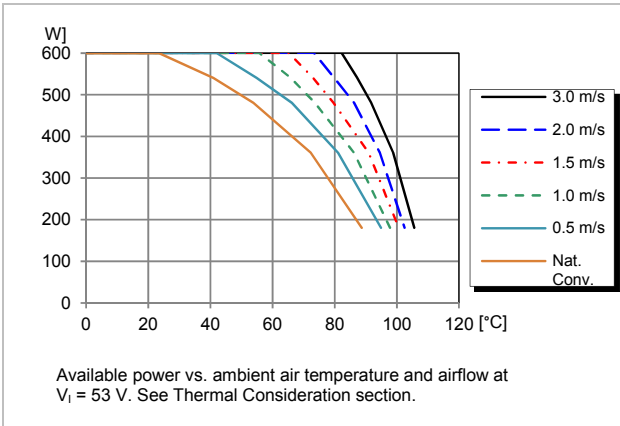

Thermal Resistance – Single pin and base plate
 (PKM4613 NH PI HS SP)

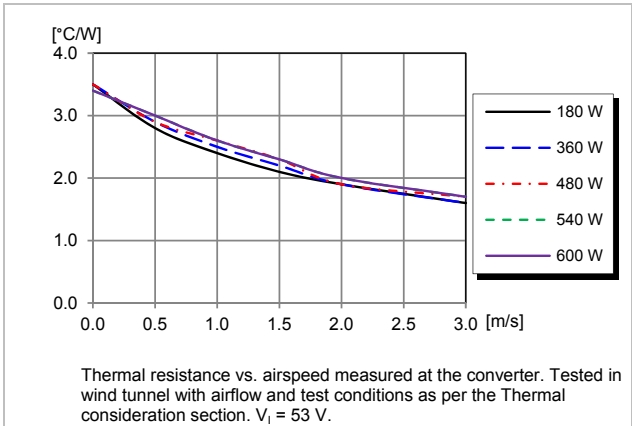

Output Power Derating – Dual pin open frame
 (PKM4613 NH PI HS)

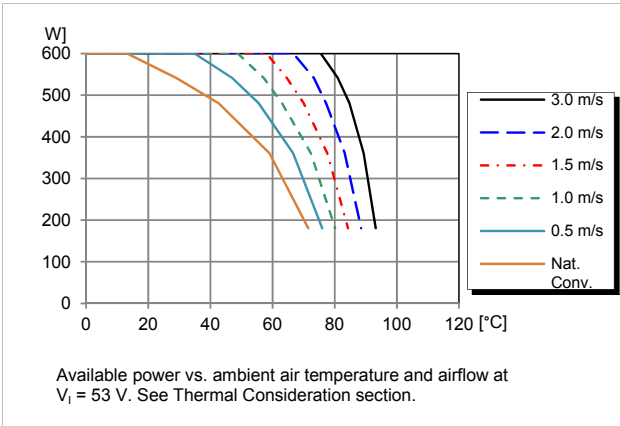

Thermal Resistance – Dual pin open frame
 (PKM4613 NH PI HS)

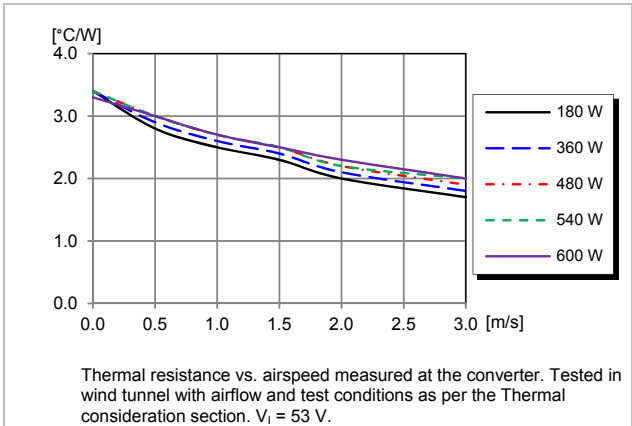

Output Power Derating – Dual pin and base plate
 (PKM4613 NH PI HS)

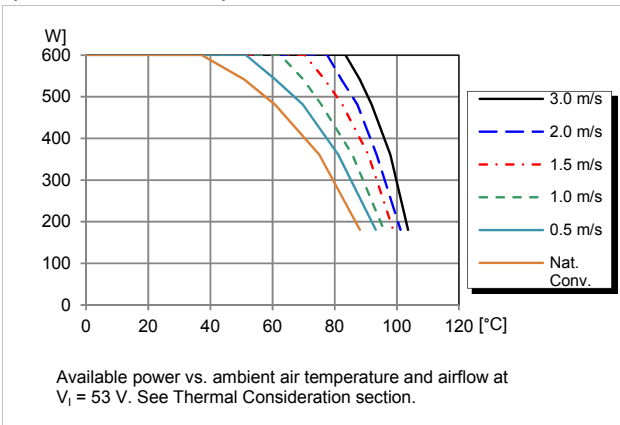

Thermal Resistance – Dual pin and base plate
 (PKM4613 NH PI HS)

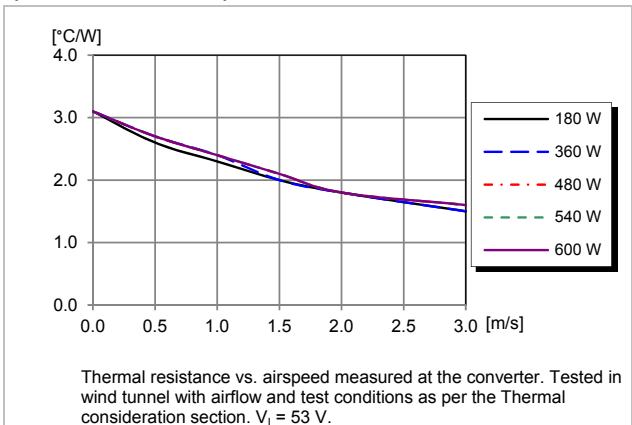

Technical Specification

PKM4613NH Fully regulated DC-DC Converters
 Input 36-75 V, Output up to 50 A / 600 W

28701-BMR669 07 Rev G

June 2023

© Flex

**Output Power Derating – Dual pin, baseplate and 1/2" heat sink
 (PKM4613 NH PI HS + 1/2" heat sink)**

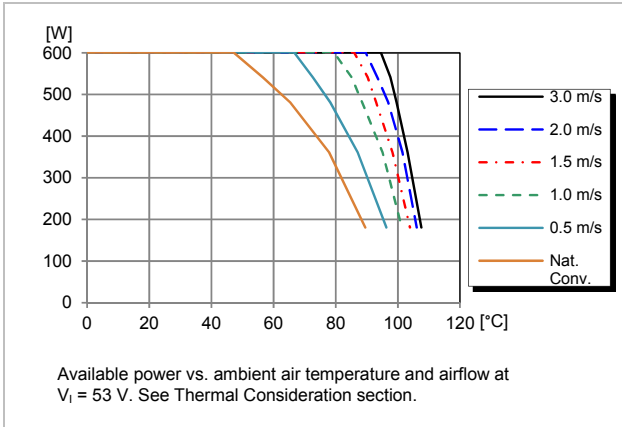

**Thermal Resistance – Dual pin, baseplate and 1/2" heat sink
 (PKM4613 NH PI HS + 1/2" heat sink)**

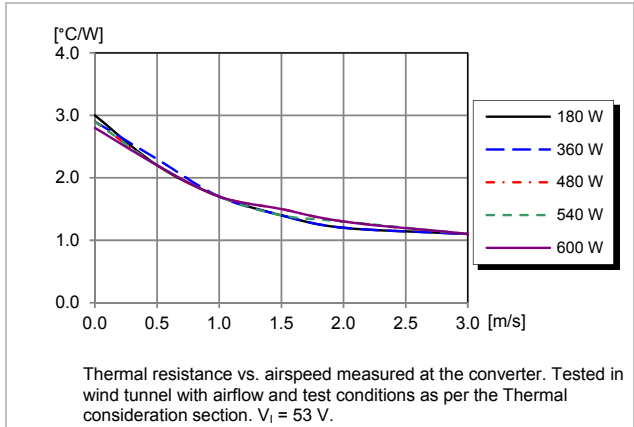

Technical Specification

PKM4613NH Fully regulated DC-DC Converters
 Input 36-75 V, Output up to 50 A / 600 W

28701-BMR669 07 Rev G

June 2023

© Flex

EMC Specification

Conducted EMI measured according to EN55022, CISPR 22 and FCC part 15J (see test set-up). See Design Note 009 for further information. The fundamental ripple frequency is 400 kHz at $V_I = 53 V$ and max I_O .

Conducted EMI Input terminal value (typ)

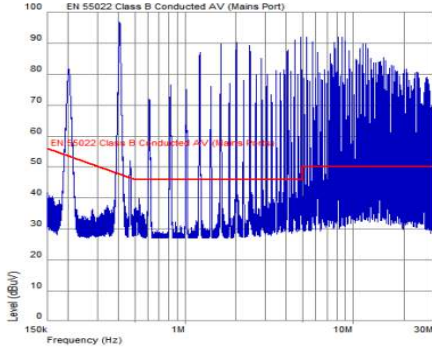

EMI without filter

Optional external filter for class B

Suggested external input filter in order to meet class B in EN 55022, CISPR 22 and FCC part 15J.

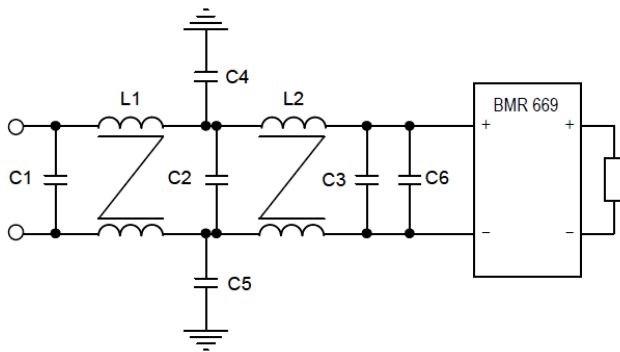

Filter components:

- C1, C2, = 5 μF
- C3 = 15 μF 100V; KRM55WR72A156MH01K (Murata)
- C6 = 470 μF 100 V; UPJ2A471MHD (Nichicon)
- C4, C5 = 20 nF, 1500V
- L1, L2 = 0.47mH

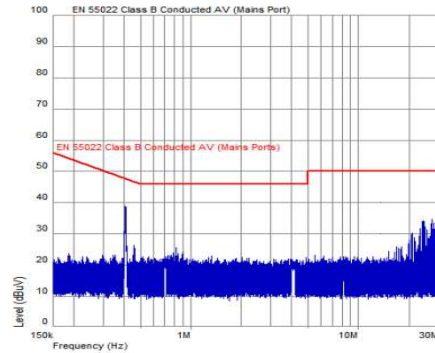

EMI with filter

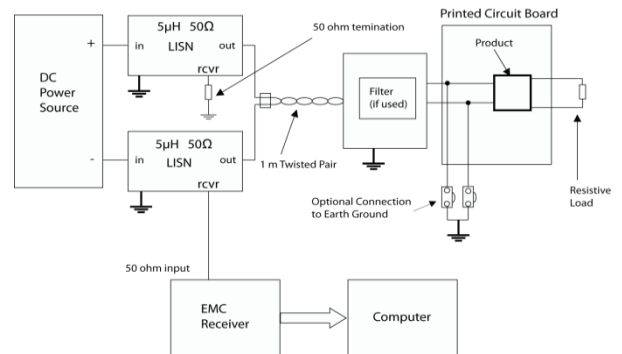

Test set-up

Layout recommendations

The radiated EMI performance of the product will depend on the PCB layout and ground layer design. It is also important to consider the stand-off of the product. If a ground layer is used, it should be connected to the output of the product and the equipment ground or chassis.

A ground layer will increase the stray capacitance in the PCB and improve the high frequency EMC performance.

Technical Specification

PKM4613NH Fully regulated DC-DC Converters
Input 36-75 V, Output up to 50 A / 600 W

28701-BMR669 07 Rev G

June 2023

© Flex

Output ripple and noise

Output ripple and noise measured according to figure below. See Design Note 022 for detailed information.

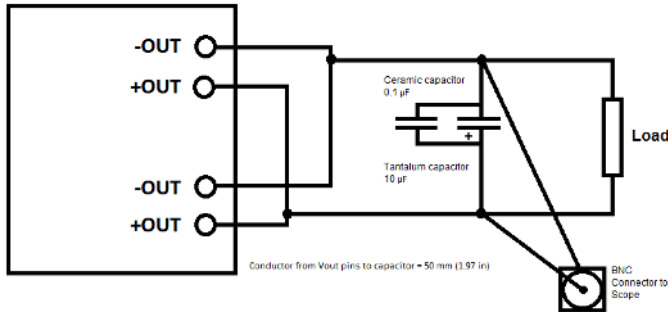

Output ripple and noise test setup

Operating information

Product Overview

The product is a crossover product that competes with the power-levels of a fixed-ratio or semi regulated product and with most of the features from a fully regulated DC/DC design still in place.

Input Voltage

The long term operational input voltage range 36 to 75 Vdc meets the requirements of the European Telecom Standard ETS 300 132-2 for normal input voltage range in -48 Vdc systems -40.5 to -57.0 V and the transitional period -60 Vdc systems, -50.0 to -72.0 V with some degradation in power.

Window of normal operations

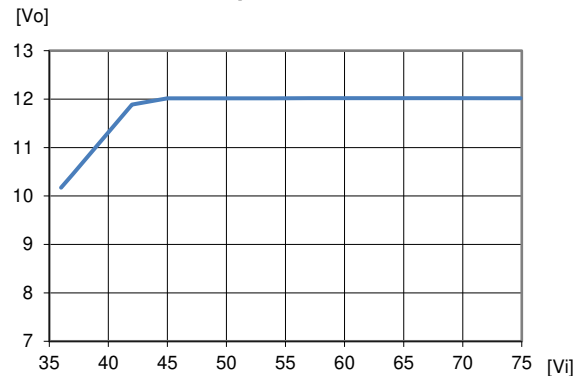

Between 43 and 75 Vin the product operates just like a normally regulated product. It handles load and line transients well and keeps a constant output voltage as well as a constant maximum power.

Below 43 Vin the output voltage starts to track the input voltage with a fixed proportion, keeping a duty-cycle guard band for regulation and runs all the way down to 36 Vin.

Available Power Graph

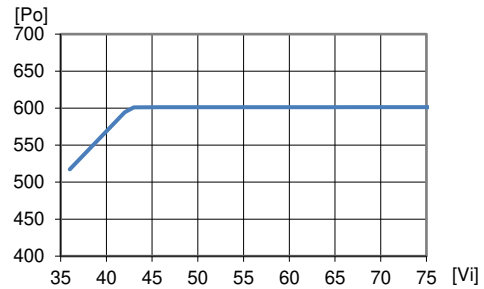

To enable a high power capability at low input voltages the input under voltage lockout is set to start the product when the input voltage reaches the typical value found in the Electrical Specification.

Input transient

Short duration transient disturbances can occur on the DC distribution and input of the product when a short circuit fault occurs on the equipment side of a protective device (fuse or circuit breaker). The voltage level, duration and energy of the disturbance are dependent on the particular DC distribution network characteristics and can be sufficient to damage the product unless measures are taken to suppress or absorb this energy. The transient voltage can be limited by capacitors and other energy absorbing devices like transient voltage suppression diodes connected across the positive and negative input conductors at a number of strategic points in the distribution network. The end-user must secure that the transient voltage will not exceed the value stated in the Absolute maximum ratings. ETSI TR 100 283 examines the parameters of DC distribution networks and provides guidelines for controlling the transient and reduce its harmful effect. The Hybrid Regulation Ratio implemented in this product ensures effective attenuation of input voltage transients. See section "Input voltage transient suppression" for further details.

Turn-on/off Input Voltage

The products monitor the input voltage and will turn on and turn off at predetermined levels that are stated in the Electrical Specification for the specific product.

The minimum hysteresis between turn on and turn off input voltage is 3 V helps avoiding start-up oscillations and repeated restarts that could occur otherwise.

Remote Control (RC)

The products are fitted with a remote control function referenced to the primary negative input connection (-In), with negative and positive logic options available. The RC function allows the product to be turned on/off by an external device like a semiconductor, or a mechanical switch placed close to the product. The RC pin has an internal pull up resistor of 10 kΩ to +5 V. The threshold level has a hysteresis and the function is designed to be robust to noise.

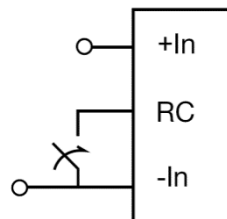

Technical Specification

PKM4613NH Fully regulated DC-DC Converters
Input 36-75 V, Output up to 50 A / 600 W

28701-BMR669 07 Rev G

June 2023

© Flex

The external device must provide a minimum required sink current to guarantee a voltage not higher than the maximum voltage on the RC pin (see Electrical characteristics table). When the RC pin is left open, the voltage generated on the RC pin is 5 V.

The standard product is provided with “negative logic” RC and will be off until the RC pin is connected to -In. To turn off the product the RC pin should be left open. To power up the product automatically, without the need for control signals or a switch, the RC pin can be wired directly to -In.

The second option is “positive logic” RC, which can be ordered by adding the suffix “P” to the end of the part number. When the RC pin is left open, the product starts up automatically when the input voltage is applied. Turn off is achieved by connecting the RC pin to -In. The product will restart automatically when this connection is opened.

The RC function incorporates a short delay in order to not trigger on glitches. Typically this filter has a settling time of 0.1-0.5 ms. This setup significantly reduces the risk for noise causing the converter to shutdown or power up accidentally.

See Design Note 021 for detailed information.

Input and Output Impedance

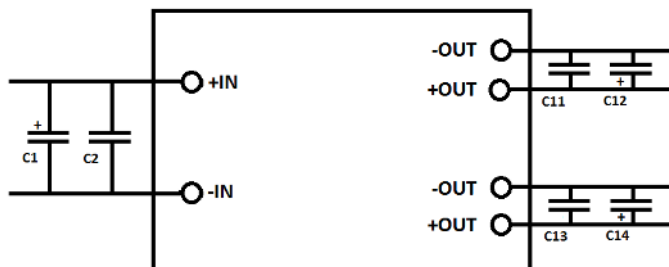

Recommended de-coupling setup

C1 = 470 μ F 100 V; UPJ2A471MHD from Nichicon or similar.
C2 = 15 μ F 100 V; KRM55WR72A156MH01K from Murata or similar close to the pins.
C11, C13 = 10 μ F 16 V; GRM31CR71C106K from Murata or similar close to the pins.
C12, C14 = 470 μ F 16 V; 16SEPC470M from Panasonic or similar in parallel with 1000 μ F 16 V;
UPJ1C102MHD from Nichicon or similar.

The components used in the recommended de-coupling setup are typical components and could be replaced with components from different manufacturers with similar characteristics. The ceramic capacitors will handle high frequency noise from switching and the OS-CON will secure de-coupling capacitance if $T_{amb} < -10^{\circ}\text{C}$.

The impedance of both the input source and the load will interact with the impedance of the product.

The application must be designed to meet the criteriaeas of both ESR and capacitance for all T_{amb} temperatures. This means that it may not be sufficient to mount a capacitor rated within the tolerances of minimum capacitance and ESR limits if these values derate due to temperature.

Input Decoupling Capacitors

It is important that the input source has low characteristic impedance. Recommended source impedance is below 100 m Ω over the T_{amb} temperature range or input oscillations may occur at start-up or at a high load current surge. Minimum external capacitance for the input is 470 μ F if it is of the electrolytic type to cater for the impedance over the temperature range. Modern stacked ceramics provide high capacitance with low ESR over a wide range of temperatures and might be considered.

Recommended input capacitors connected in parallel as follows:

470 μ F 100 V; UPJ2A471MHD from Nichicon or similar, 15 μ F 100 V stacked ceramics; KRM55WR72A156MH01K from Murata or similar.

This means that the input capacitor value may need to be substantially larger than specified minimum capacitance, if the ESR of the impedance increase, to maintain a stable input at low temperatures.

Output Decoupling Capacitors

When powering loads with significant dynamic current requirements, the voltage regulation at the point of load can be improved by addition of decoupling capacitors close to the load. The most effective technique is to locate very low ESR capacitors as close to the load as possible and, if needed, the bulk of capacitance with low ESR close to the converter output.

OS-CON type of capacitor has very low ESR and very good performance in both warm and cold conditions and therefore this type is recommended to place as near the point of load as possible for de-coupling the load.

Ceramic type of capacitor has also very low ESR and they are cheap in comparison to OS-CON. Drawbacks are derating due to bias voltage and temperature.

The use of very low ESR capacitors is restricted due to the high Q- value and stable operation is guaranteed with a verified ESR value of >10 m Ω across the output connections. If the application cannot guarantee the ESR condition it is possible to dampen the Q- value by adding an appropriate resistor in series with the capacitance or by mounting the very low ESR close to the point of load and thereby include the conductor resistance in the loop.

For ceramic capacitors it is not recommended to use more than 1 mF (rated capacitance) close to the converter output connections.

As an example it is not recommended to mount more than two (2) Panasonic SEPC 470 μ F 16 V (OS-CON) in parallel close to the converter output connections as using several parallel capacitors will lower the effective ESR.

The recommended type of capacitance to place near the converter output connections is a low ESR aluminium electrolyte in parallel with a ceramic capacitor according to the picture under “Input and Output Impedance”. It is recommended

Technical Specification

PKM4613NH Fully regulated DC-DC Converters
Input 36-75 V, Output up to 50 A / 600 W

28701-BMR669 07 Rev G

June 2023

© Flex

that this type of capacitance is used as bulk in high capacitive load application. The aluminium electrolyte works well with the converter but it is important to choose proper temperature classification as this has impact on the expected life span. Cold conditions have great impact on ESR value for the aluminium electrolyte; if cold environment is expected this must be considered and a component with ESR rated for low temperatures is preferred to secure performance.

The ceramic capacitors will handle high-frequency dynamic load changes while the electrolytic capacitors are used to handle low frequency dynamic load changes. It is equally important to use low resistance and low inductance PCB layouts and cabling.

External decoupling capacitors will become part of the product's control loop. The control loop is optimized for a wide range of external capacitance and the maximum recommended value that could be used without any additional analysis is found in the Electrical Specification.

The end user must secure that the used capacitance is within specified limits described under External Decoupling Capacitors for all ambient temperatures as this highly impact ESR performance and capacitance.

Recommended output capacitors connected in parallel per output branch as follows:

470 μ F 16 V; 16SEPC470M from Panasonic or similar,
1000 μ F 16 V; UPJ1C102MHD from Nichicon or similar.

For further information please contact your local Ericsson Power Modules representative.

Hybrid Regulated Ratio (HRR)

The product uses two regulation modes. The regulated ratio mode let the regulator track the V_{in} with a fixed proportion, still with a guard band for load and transient regulation. The hybrid regulated mode swaps seamlessly from a ratio regulated mode to a normally regulated mode above a certain input voltage. See Output Characteristics in the Electrical Specification.

HRR uses a fast adaption system and a slow adaption system to react to both fast and slow input voltage changes to provide an input voltage feed-forward function. The fast adaption system prevents the converter to change output voltage very rapid. It filters sudden input voltage changes. The slow adaption system does not let fast input voltage transients through in the regulated ratio mode, it just slowly adapts to the new input voltage. When the input voltage changes the tracking system needs up to 3 ms to fully respond.

In the normally regulated mode the tracking will be saturated and the converter regulates towards a precision reference voltage instead making it almost unsusceptible to transients.

Controlled low external output capacitor charge current at input voltage step

Due to the slow adaption system the HRR product efficiently reduces those charge currents for the external capacitors during an input voltage transient or level shift.

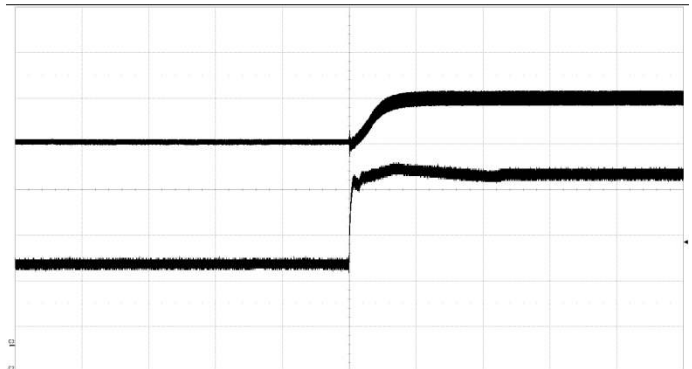

HRR product output at input voltage step 36-75 V, 1 ms/div
Bottom trace – input voltage change 36-75 V, 20 V/div
Top trace – resulting output voltage change, 1 V/div

Input voltage transient suppression

The hybrid regulated product effectively suppress input voltage transients. This applies to both short duration transients and step-like level shifts of the input voltage.

The amplitude of the output transients resulting of short duration transient at the input voltage will be less than 1V.

In case of a step-like level shift of the input voltage, the output voltage will rise to a new regulated ratio output voltage, described in Window of operation, or to 12V depending of the final value of the input voltage step. The hybrid regulated ratio prevents overshoots and undershoots in association with this transition. These capabilities significantly reduce the requirements on input transient response of Point of Load regulators fed from this product.

Parallel Operation, without Droop Load Share function

Two or more products may be paralleled for redundancy if the total power is less than $(n-1) \cdot P_{O\ max}$. External current sharing circuits must be used.

See Design Note 006 for detailed information.

Over Temperature Protection (OTP)

The products are protected from thermal overload by an internal over temperature shutdown circuit.

When T_{P1} as defined in thermal consideration section exceeds 135°C the product will shut down. The product will make continuous attempts to start (non-latching mode).

Over Voltage Protection (OVP)

The products have output over voltage protection that will shut down the product in over voltage conditions. The product will resume normal operation automatically after removal of the over voltage condition. The OVP setpoint can be found in the Electrical Specification.

The input over voltage protection will stop the switching and the output will be left as is when the converter reach the input voltage specified in the Electrical Specification. The converter will resume normal operation when V_{in} drop below the voltage specified in the Electrical Specification.

Over Current Protection (OCP)

The products include current limiting circuitry for protection at

Technical Specification

PKM4613NH Fully regulated DC-DC Converters
Input 36-75 V, Output up to 50 A / 600 W

28701-BMR669 07 Rev G

June 2023

© Flex

continuous overload. It is made up of one real-time (peak) current monitor that constitutes a power limiter and another part which detects longer overloads and enters a delayed hiccup. At output currents in excess of maximum output current (max I_o) the output voltage decrease towards zero and the current increase. If the overload persist the converter will after ~1.6 ms enter hiccup, disable the output and then make continuous restart attempts after a first timeout period, creating a delayed hiccup. The delay is set to a significantly longer time than the activation time (~200:1) in order to create low rms-currents in a fault condition. The timer and OCP setpoint are set to not trig on capacitive load during start-up, or cut-in during input voltage transients. The product will resume normal operation after removal of the overload. The load distribution should be designed for the maximum output OCP current specified in the Electrical Specification.

Pre-bias Start-up

The product has a Pre-bias start up functionality and will not sink current during start up if a Pre-bias source is present at the output terminals.

To guarantee a correct pre-bias start-up a minimum load of 20 mA is needed at any time output voltage is above 7V. When output voltage is above 7V the start-up time will be dependent of load and capacitance. Typical applications with PoL's loading the module will generally provide the minimum loading to insure standard ramp rates for start-up.

At shutdown, OVP or OTP, the product will directly shut off the synchronous rectification to avoid reverse current.

The product will not start-up if the output voltage is higher than the OVP-level specified in the Electrical Specification.

Soft Start

The soft start function ramps up the output voltage. The main purpose is to control the charging current to the external output capacitors. The ramp-up is however pretty fast so there is a significant inrush current at the maximum capacitive load. The inrush current could lower the input rail, if the input impedance is too high. See the Input and Output impedance section. If the input voltage drops below 35 V the converter stops and makes new start-attempts when the input voltage bounces back up.

Boosted hold-up applications

These products support hold up solutions with boosted hold-up capacitors that is hot-swapped to the input voltage rail at power-off of the original feed. Ericsson offers Power Input Module, PIM 4820B with such functionality.

If the input capacitance to the converter is small, the input voltage drops faster than 5 V/ms in the Regulated Ratio range below 45 V, the product will take some time to get back in regulated ratio mode again when the voltage returns and this leads to an overshoot. The smaller the input capacitor the higher the hot insertion point for the boosted capacitor should be. Use the range as close to the maximum input voltage, 72 V, as possible instead of just 60 V. A proper setting will result in a smooth output voltage without overshoot. Using too low input voltage cut-over levels might result in a slight overshoot at the output due to the longer adaption time in the regulated ratio mode (below 50 V). If a glitch is acceptable, it should be kept

below the OVP activation level, typically 15 V.

PIM modules from Ericsson Power Modules shall be set to their highest set point, 44 V, and the boost level shall be adjusted to reach to 72 V in the application. I.e. the level needs to be adjusted to more than 72 V, approximately to 75 V. Consult the technical specification for the PIM-product regarding PIM-setting possibilities and features.

For further information please contact your local Ericsson Power Modules representative.

Boosted Hold-up function; Idling

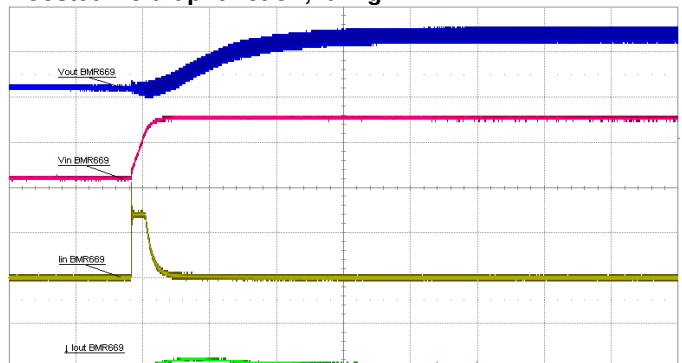

Blue line – output voltage 1 V/div

Red line – input voltage change 54-44-72 V, 20 V/div

Yellow line –input current supplied from the HU- capacitor, 50 A/div

Green line – output current, 50 A/div

2 ms/div

HRR product output at boosted hold up voltage step 54-44-72 V

Ericsson evaluation board ROA 128 5151 R1A with HU capacitor 3x470 μF +3300 μF with a PIM 4820B PD R3A mounted on used as PIM.

HRR product decoupled with minimum recommended input and output capacitance specified in the Electrical Specification.

Ericsson evaluation board ROA 128 5077 R2A produce a rail with 7 pcs BMR 464 0002/001 R3B in parallel as current sharing an electrical load to represent a 0 W load for the HRR.

Boosted Hold-up function; Po = 756 W

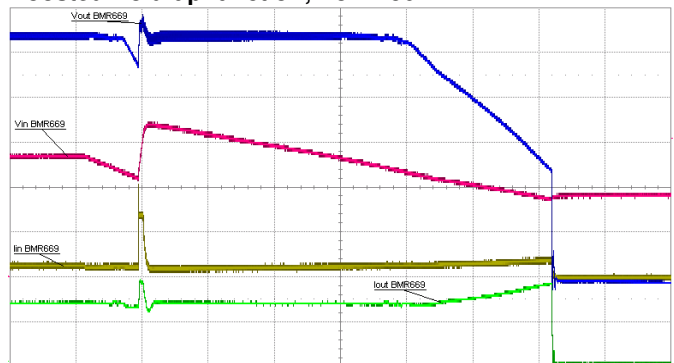

Blue line – output voltage peak at 11.3 V, 1 V/div

Red line – input voltage change 54-44-72 V, 20 V/div

Yellow line –input current supplied from the HU- capacitor, 50 A/div

Green line – output current, 50 A/div

2 ms/div

HRR product output at boosted hold up voltage step 54-44-72 V

Ericsson evaluation board ROA 128 5151 R1A with HU capacitor 3x470 μF +3300 μF with a PIM 4820B PD R3A mounted on used as PIM.

Technical Specification

PKM4613NH Fully regulated DC-DC Converters Input 36-75 V, Output up to 50 A / 600 W	28701-BMR669 07 Rev G	June 2023
	© Flex	

HRR product decoupled with minimum recommended input and output capacitance specified in the Electrical Specification.
Ericsson evaluation board ROA 128 5077 R2A produce a rail with 7 pcs BMR 464 0002/001 R3B in parallel as current sharing an electrical load to represent a 756 W load for the HRR.

Isolation

The open frame products have 2250 V input to output functional isolation. Leaving the baseplate free-floating means that the 2250 V input to output isolation voltage is kept. Steady-state the voltage across the isolation barrier is not higher than the input voltage, maximum 75 V, and the output voltage together.

In order to keep the 2250 V functional isolation voltage between the product and the host board the keep away areas for components and traces must be followed according to the Mechanical Information section or the clearance must be increased to at least 1.5 mm or insulated with approved isolation material according to the desired isolation voltage level. The minimum stand-off is 0.5 mm and the corresponding functional isolation voltage is 1500 V. See the Mechanical Information section for more information.

Baseplate grounding

Variants with baseplate have the baseplate floating. The baseplate can be grounded externally via the threaded holes in the baseplate. In the latter case the isolation voltage is reduced and qualified values are stated in the Absolute Maximum Ratings.

Possibility to order variants with the baseplate grounded either to +In or –Out might be added to the program.

Thermal Consideration**General**

The products are designed to operate in different thermal environments and sufficient cooling must be provided to ensure reliable operation.

For products mounted on a PCB without a heat sink attached, cooling is achieved mainly by conduction, from the pins to the host board, and convection, which is dependant on the airflow across the product. Increased airflow enhances the cooling of the product. The Output Power Derating graph found in the Typical Characteristics section for each model provides the available output power vs. ambient air temperature and air velocity at 53 Vin.

To enhance the thermal transfer the products are available with a baseplate as well as dual output pins. The products respond well on cooling methods due to its low internal thermal resistance.

Convection cooling

The products power density is up to 405 W/cubic inch leaving a limited area for convection cooling and the heat generated is significant at high load. Just air flow is not sufficient for the product to deliver full power at high ambient temperatures. In the section Typical characteristics, Output Power derating – Different cooling, the benefits of base plate and heat sink is

clearly visualized. The absolute best performance can be obtained by using the highest heat sink possible that allows the most air to be forced through and thereby increase cooling.

Conduction cooling

The thermal design is made to ease the transfer of heat from the product via both the input and the output power pins. The optional baseplate can be connected to a cold wall. See the Typical Characteristics section for graphs.

Dual output pins

Products with dual output pins have from 2 and up to 20°C better thermal derating than single pin products.

As well as decreasing the power losses in the pins, dual pins will spread both the current and the heat better on the host board reducing the stress on the solder joints. For backward compability and designs using less than 500 W output power the single pin products can be used with up to 5 °C worse derating.

See Typical Characteristics section for more details.

Layout considerations

Recommended host board footprint and plated through hole dimensions are defined by best practices to combine low resistance current/power distribution, standard mounting assembly techniques and relevant tolerances. When deviations in e.g. through plated hole sizes are applicable by end user, alternative techniques as wash away spacers, tailored fixtures or gap pads can be used by manufacturers to secure product form factor and functionality.

Inappropriate assembly techniques can stress the interconnection leads of the module and reduce the thermal coupling between e.g. the module's base plate and cold wall.

Special care should be paid to the current distribution flow within the host board by appropriate amount of copper layers/traces/interconnecting vias.

If the pins are connected to a plane in the host board this will become an efficient heat sink and significantly increase the maximum power before maximum temperature is reached. The outer layer on the host board should have a large number of vias close to the outside of the pins' shoulders in order to improve current and heat spreading between the host board and the product. The current and heat bottleneck is often close to the pin and it might be good to use extra PCB layers to connect to the pin and let the vias around the standoff spread the power to the power planes. For further information please contact your local Ericsson Power Modules representative.

Technical Specification

PKM4613NH Fully regulated DC-DC Converters
 Input 36-75 V, Output up to 50 A / 600 W

28701-BMR669 07 Rev G

June 2023

© Flex

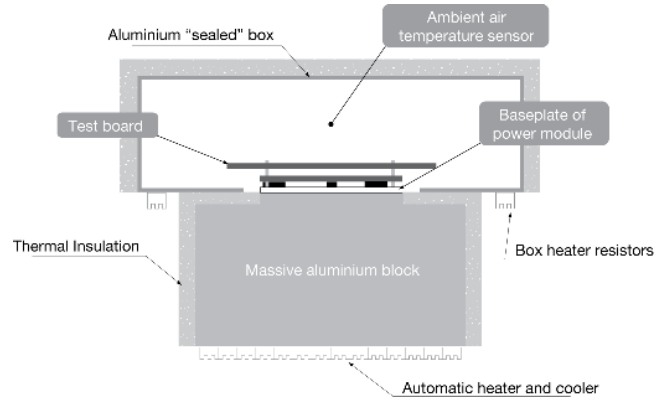
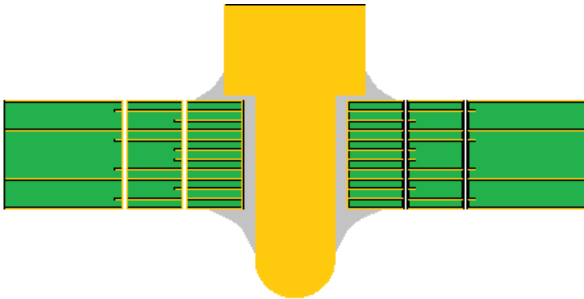

Baseplate

The baseplate itself improves the performance by smoothening out the local hotspots on the converter. The other advantage is that it is an efficient way to dissipate heat from the product. Connected to a heatsink or a coldwall higher power can be delivered at high ambient temperatures. This also opens up for the use of advanced cooling technologies such as heatpipes or liquid cooling. See the Typical Characteristics section for graphs on different cooling and pinning options.

The product is tested on a 254 x 254 mm, 35 µm (1 oz), 16-layer test board mounted vertically in a wind tunnel with a cross-section of 608 x 203 mm.

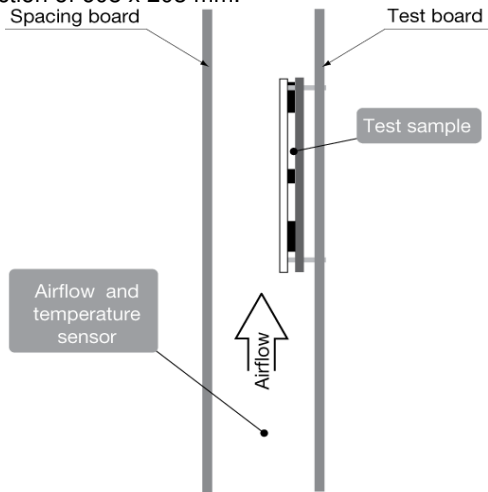

For products with base plate used in a sealed box/cold wall application, cooling is achieved mainly by conduction through the cold wall. The Output Current Derating graphs are found in the Output section for each model. The product is tested in a sealed box test set up with ambient temperatures 85°C at different output power conditions. See Design Note 028 for further details.

Definition of product operating temperature

The product operating temperatures is used to monitor the temperature of the product, and proper thermal conditions can be verified by measuring the temperature at positions P1, P2, P3 and P4. The temperature at these positions (T_{P1}, T_{P2}, T_{P3}, T_{P4}) should not exceed the maximum temperatures in the table below. The number of measurement points may vary with different thermal design and topology. Temperatures above maximum T_{P1}, T_{P2}, T_{P3} and T_{P4}, measured at the reference points P1, P2, P3 and P4 are not allowed and may cause permanent damage.

Position	Description	Max Temp.
P1	Pcb prim	T _{P1} =125° C
P2	M300	T _{P2} =125° C
P3	T203	T _{P3} =125° C
P4	N305	T _{P4} =125° C

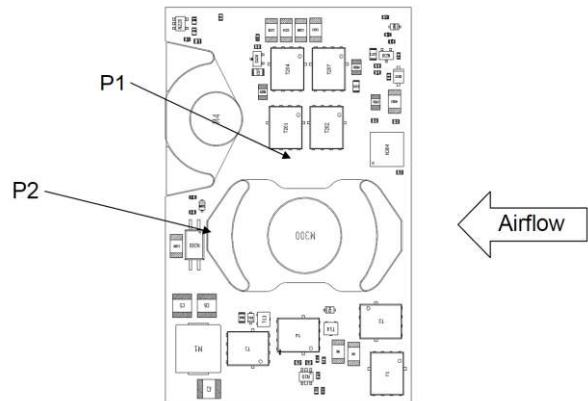

Open frame reference points

Technical Specification

PKM4613NH Fully regulated DC-DC Converters
Input 36-75 V, Output up to 50 A / 600 W

28701-BMR669 07 Rev G

June 2023

© Flex

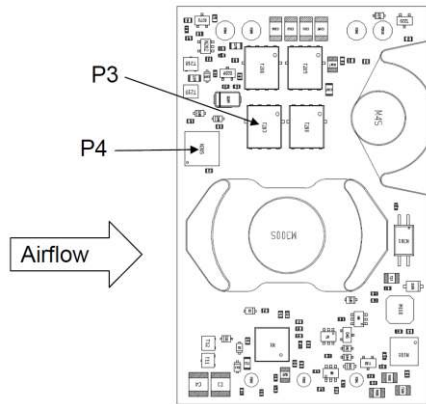

Reference points on a product equipped with a baseplate

Ambient Temperature Calculation

For products with baseplate the maximum allowed ambient temperature can be calculated by using the thermal resistance.

1. The power loss is calculated by using the formula

$$\left(\frac{1}{\eta} - 1\right) * \text{output power} = \text{power losses } (P_d)$$

η = efficiency of product, e.g. 96.4% = 0.964

2. Find the thermal resistance (R_{th}) in the Thermal Resistance graph found in the Output section for each model. **Note that the thermal resistance can be significantly reduced if a heat sink is mounted on the top of the base plate.**

Calculate the temperature increase (ΔT).

$$\Delta T = R_{th} * P_d$$

3. Max allowed ambient temperature is:

$$\text{Max } T_{P1} - \Delta T.$$

E.g. PKM 4717NH PI, open frame at 1m/s:

$$1. \left(\left(\frac{1}{0.964}\right) - 1\right) * 756 W = 28.2 W$$

$$2. 28.2W * 2.9^\circ C/W = 81.8^\circ C$$

$$3. 125^\circ C - 81.8^\circ C = \text{max ambient temperature is } 43.2^\circ C$$

4. The thermal performance can be significantly improved by mounting a heat sink on top of the base plate.

The thermal resistance between base plate and heat sink, $R_{th, b-h}$ is calculated as:

$$R_{th, b-h} = \frac{(T_{base\ plate} - T_{heat\ sink})}{R_{th}}$$

The actual temperature will be dependent on several factors such as the PCB size, number of layers and direction of airflow.

Connections

The picture shows the bottom view of the module.

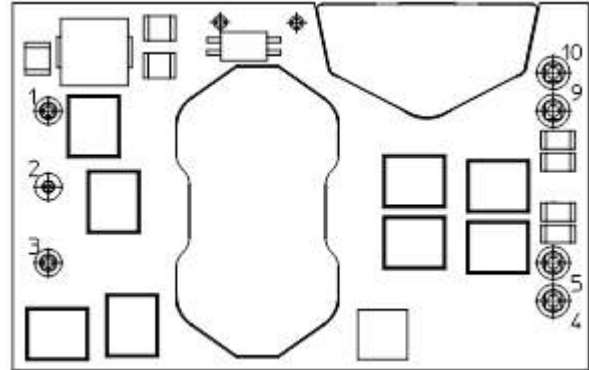

Pin	Designation	Function
1	+In	Positive Input
2	RC	Remote Control
3	-In	Negative Input
4	+Out	Positive Output
5	-Out	Negative Output
9	+Out	Positive output
10	-Out	Negative output

Optionally pins 4 and 10 can be omitted but for thermal reasons and optimal current distribution this is not recommended. See Typical Characteristics for thermal information.

Technical Specification

PKM4613NH Fully regulated DC-DC Converters
Input 36-75 V, Output up to 50 A / 600 W

28701-BMR669 07 Rev G

June 2023

© Flex

Mechanical Information - Hole Mount, Open Frame Version

Height Max 11.4 [0.448]

Lead length See table 1

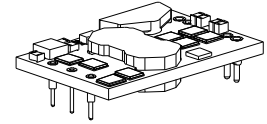
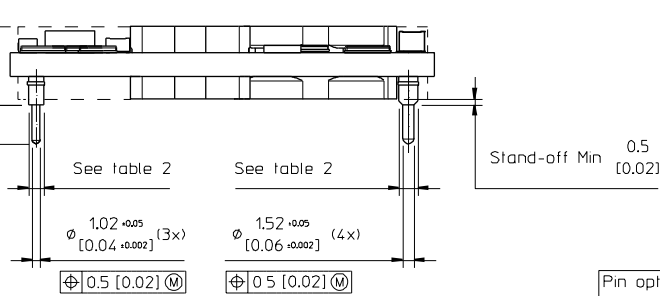

TOP VIEW
Pin positions according to recommended footprint
57.93 ±0.50 [2.28 ±0.02]

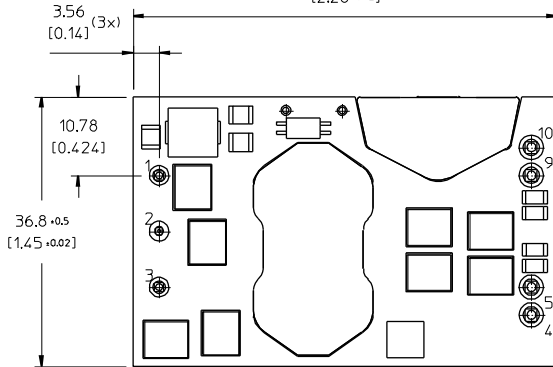

RECOMMENDED FOOTPRINT - TOP VIEW
61.3 [2.415]

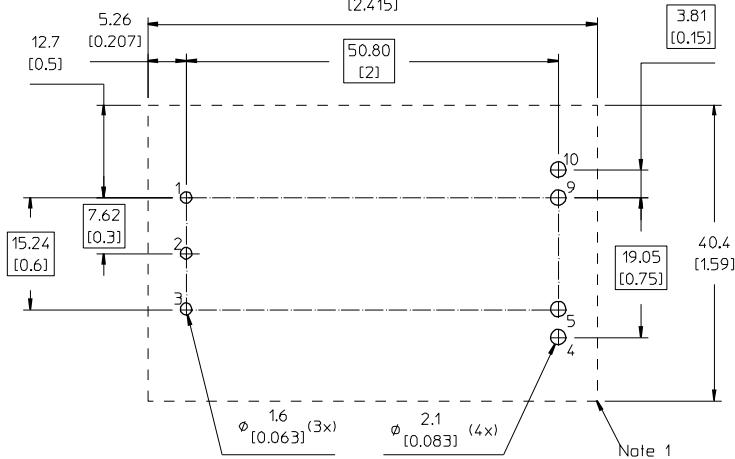

Note 1

Pin options	Standard	Wide shoulder
Footprint	Single/Dual pin out	Single pin out
Pins 1,3	∅2.03[0.08"]	∅2.54 [0.10"]
Pins 5,9	∅2.54[0.10"]	∅3.05 [0.12"]
Pins 4,10	∅2.54[0.10"]	N/A

Table 2

	Lead length
Standard	5.33 [0.210]
LA	3.69 [0.145]
LB	4.57 [0.180]
LC	2.79 [0.110]

Table 1

Pins
Pin 1, 3, 4, 5, 9 & 10 Material: Copper alloy
Pin 2 Material: Brass alloy
Pin positions 4 & 10 are optional
Plating: Min Au 0.1 μm over 1-3 μm Ni

Note 1: Recommended keep away area for user components to withstand input to output isolation voltage according to absolute maximum ratings.

Footprint

Single pin out - Pins 4 & 10 not used
Dual pin out - Pin 4 & 10 used
Recommended hole dimensions are only for reference. It's end users' decision based on different situations like productions process, substrate thickness, etc

Weight: Typical 54 g

All dimensions in mm [inch].

Tolerances unless specified

x.x mm ±0.50 mm [0.02], x.xx mm ±0.25 mm [0.01] (not applied on footprint or typical values)



Technical Specification

PKM4613NH Fully regulated DC-DC Converters
Input 36-75 V, Output up to 50 A / 600 W

28701-BMR669 07 Rev G

June 2023

© Flex

Mechanical Information- Hole Mount, Base Plate Version

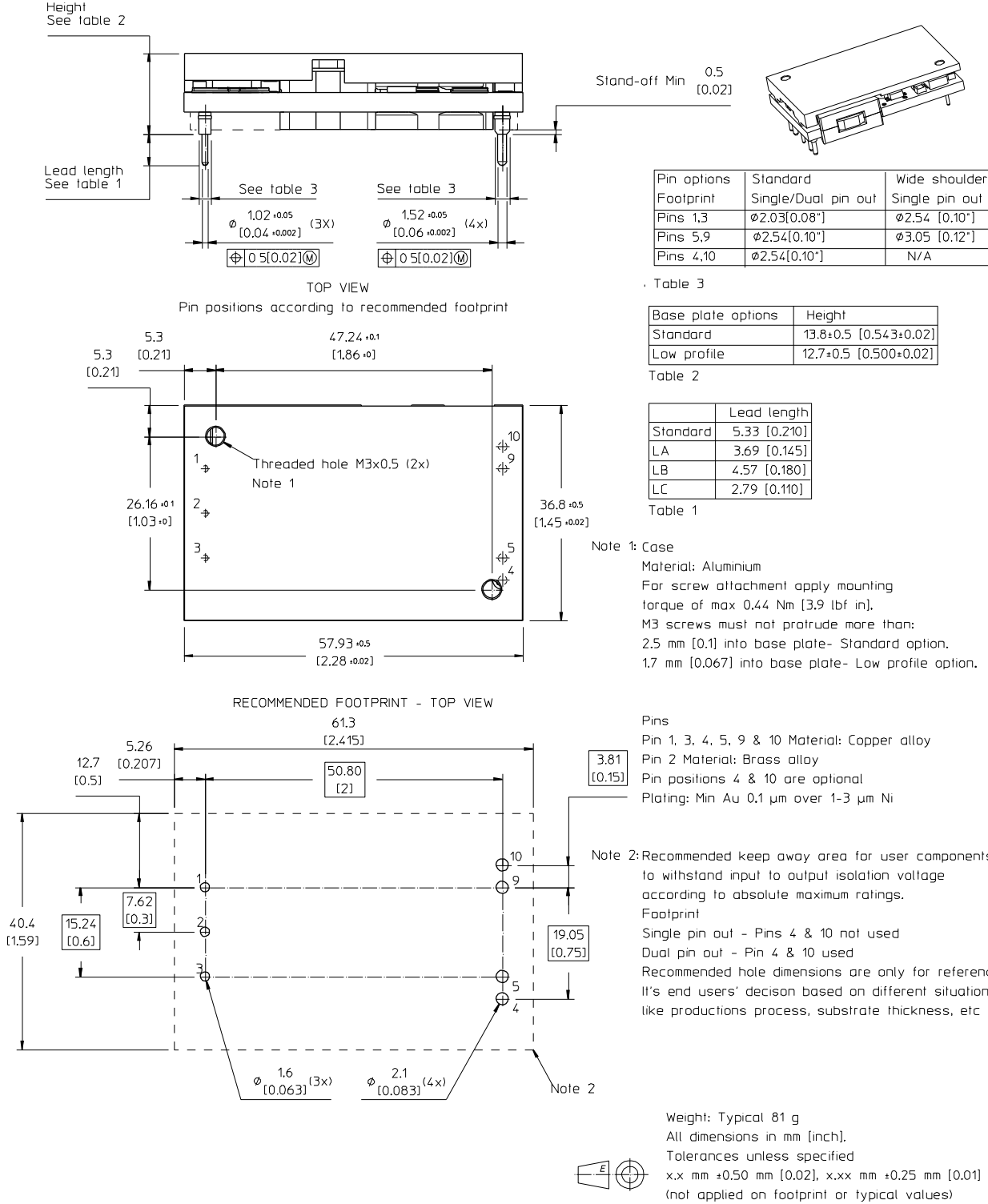

All component placements – whether shown as physical components or symbolical outline – are for reference only and are subject to change throughout the product's life cycle, unless explicitly described and dimensioned in this drawing.

Technical Specification

PKM4613NH Fully regulated DC-DC Converters
 Input 36-75 V, Output up to 50 A / 600 W

28701-BMR669 07 Rev G

June 2023

© Flex

Mechanical Information- Layout information

Top view - Layout restrictions

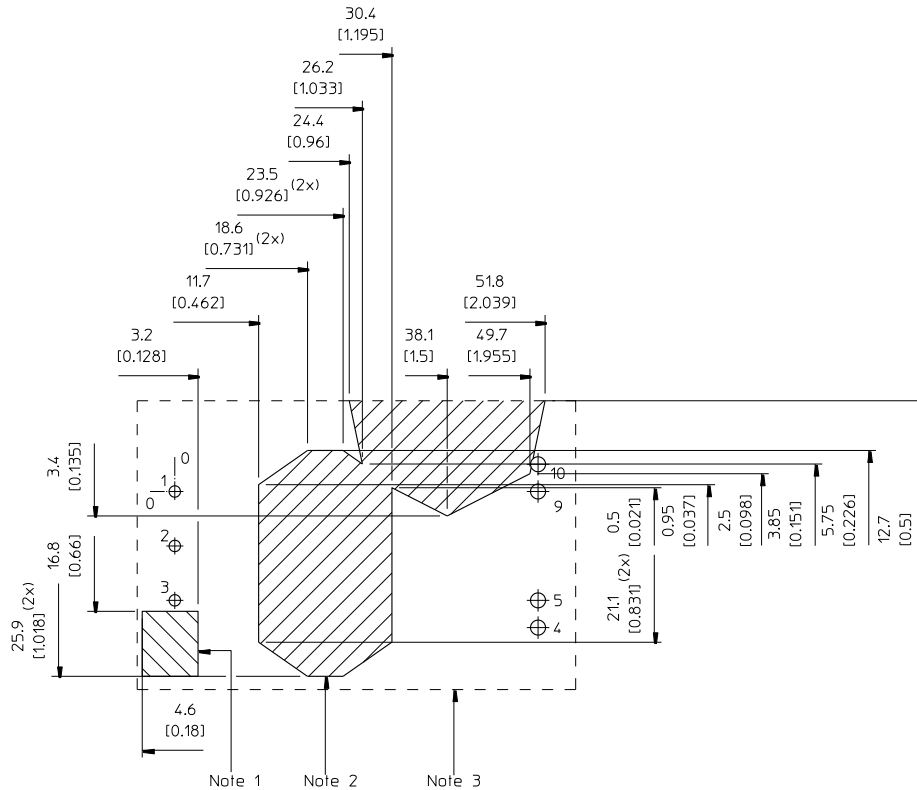

Keep away area criterion:
 1.5mm [0.059"] safety clearance between input and output circuitry acc. to IEC 60950-1; 2250V.
 Assembly tolerances are included.
 Note 1: Capacitors
 Recommended keep away area for open vias/traces connected to output circuitry to withstand input to output isolation voltage according to absolute maximum ratings.
 Note 2: Ferrite cores
 Recommended keep away area for open vias/traces connected to input circuitry to withstand input to output isolation voltage according to absolute maximum ratings.
 Note 3: Outline according to recommended footprint.

All dimensions in mm [inch].
 Tolerances unless specified
 x.x mm ±0.5 mm [0.02], x.xx mm ±0.25 mm [0.01]
 (not applied on footprint or typical values)

Technical Specification

PKM4613NH Fully regulated DC-DC Converters
Input 36-75 V, Output up to 50 A / 600 W

28701-BMR669 07 Rev G June 2023
© Flex

Soldering Information – Hole Mount through Pin in Paste Assembly

The pin in paste mount product (“B” or “C” option) is intended for forced convection or vapor phase reflow soldering in SnPb and Pb-free processes.

The reflow profile should be optimised to avoid excessive heating of the product. It is recommended to have a sufficiently extended preheat time to ensure an even temperature across the host PWB and it is also recommended to minimize the time in reflow.

A no-clean flux is recommended to avoid entrapment of cleaning fluids in cavities inside the product or between the product and the host board, since cleaning residues may affect long time reliability and isolation voltage.

General reflow process specifications		SnPb eutectic	Pb-free
Average ramp-up ($T_{PRODUCT}$)		3°C/s max	3°C/s max
Typical solder melting (liquidus) temperature	T_L	183°C	221°C
Minimum reflow time above T_L		60 s	60 s
Minimum pin temperature	T_{PIN}	210°C	235°C
Peak product temperature	$T_{PRODUCT}$	225°C	260°C
Average ramp-down ($T_{PRODUCT}$)		6°C/s max	6°C/s max
Maximum time 25°C to peak		6 minutes	8 minutes

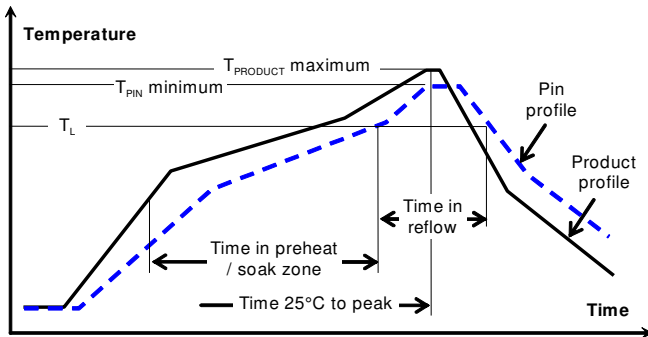

Minimum Pin Temperature Recommendations

Pin number 4 is chosen as reference location for the minimum pin temperature recommendation since this will likely be the coolest solder joint during the reflow process.

SnPb solder processes

For SnPb solder processes, a pin temperature (T_{PIN}) in excess of the solder melting temperature, (T_L , 183°C for Sn63Pb37) for more than 60 seconds and a peak temperature of 220°C is recommended to ensure a reliable solder joint.

For dry packed products only: depending on the type of solder paste and flux system used on the host board, up to a recommended maximum temperature of 245°C could be used, if the products are kept in a controlled environment (dry pack handling and storage) prior to assembly.

Lead-free (Pb-free) solder processes

For Pb-free solder processes, a pin temperature (T_{PIN}) in excess of the solder melting temperature (T_L , 217 to 221°C for SnAgCu solder alloys) for more than 60 seconds and a peak temperature of 245°C on all solder joints is recommended to ensure a reliable solder joint.

Maximum Product Temperature Requirements

Top of the product PWB near pin 2 is chosen as reference location for the maximum (peak) allowed product temperature ($T_{PRODUCT}$) since this will likely be the warmest part of the product during the reflow process.

SnPb solder processes

For SnPb solder processes, the product is qualified for MSL 1 according to IPC/JEDEC standard J-STD-020C.

During reflow $T_{PRODUCT}$ must not exceed 225 °C at any time.

Pb-free solder processes

For Pb-free solder processes, the product is qualified for MSL 3 according to IPC/JEDEC standard J-STD-020C.

During reflow $T_{PRODUCT}$ must not exceed 260 °C at any time.

Dry Pack Information

Products intended for Pb-free reflow soldering processes are delivered in standard moisture barrier bags according to IPC/JEDEC standard J-STD-033 (Handling, packing, shipping and use of moisture/reflow sensitivity surface mount devices).

Using products in high temperature Pb-free soldering processes requires dry pack storage and handling. In case the products have been stored in an uncontrolled environment and no longer can be considered dry, the modules must be baked according to J-STD-033.

Thermocoupler Attachment

Top of PWB near pin 2 for measurement of maximum product temperature, $T_{PRODUCT}$

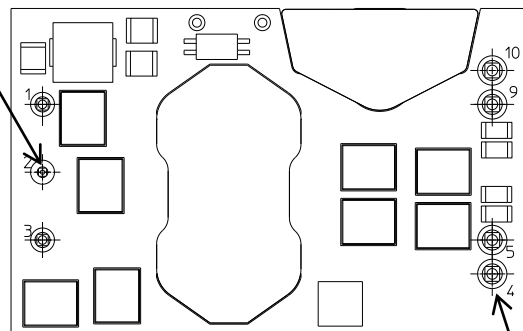

Pin 4 for measurement of minimum pin (solder joint) temperature, T_{PIN}

Technical Specification

PKM4613NH Fully regulated DC-DC Converters
 Input 36-75 V, Output up to 50 A / 600 W

28701-BMR669 07 Rev G

June 2023

© Flex

Soldering Information - Hole Mounting

The hole mounted product is intended for plated through hole mounting by wave or manual soldering. The pin temperature is specified to maximum to 270°C for maximum 10 seconds.

A maximum preheat rate of 4°C/s and maximum preheat temperature of 150°C is suggested. When soldering by hand, care should be taken to avoid direct contact between the hot soldering iron tip and the pins for more than a few seconds in order to prevent overheating.

A no-clean flux is recommended to avoid entrapment of cleaning fluids in cavities inside the product or between the product and the host board. The cleaning residues may affect long time reliability and isolation voltage.

Delivery Package Information

The products are delivered in antistatic polystyrene trays, antistatic PE foam trays or antistatic PPE trays.

Tray Specifications	
Material	Antistatic PE Foam
Surface resistance	$10^5 < \text{Ohm/square} < 10^{12}$
Bakability	The trays are not bakable
Box capacity	20 products (1 full tray/box)
Tray weight	Product – Open Frame Version 140 g empty, 1220 g full tray Product – Base Plate Version 140 g empty, 1760 g full tray

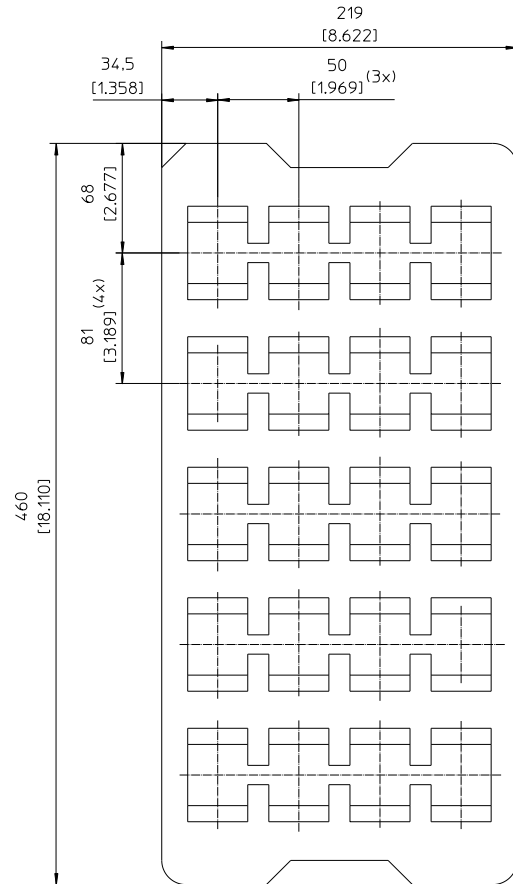

Technical Specification

PKM4613NH Fully regulated DC-DC Converters
 Input 36-75 V, Output up to 50 A / 600 W

28701-BMR669 07 Rev G

June 2023

© Flex

Tray Specifications –Base plate version (dry pack, pick & place)	
Material	Antistatic PPE
Surface resistance	$10^5 < \text{Ohm/square} < 10^{11}$
Bakability	The trays can be baked at maximum 125°C for 48 hours
Tray thickness	25 mm 0.984 [inch]
Box capacity	40 products (4 full trays/box) 42 products (3 full trays/box)
Weight	1030 g full tray – 10pcs/tray 1330 g full tray – 14pcs/tray

14pcs/tray

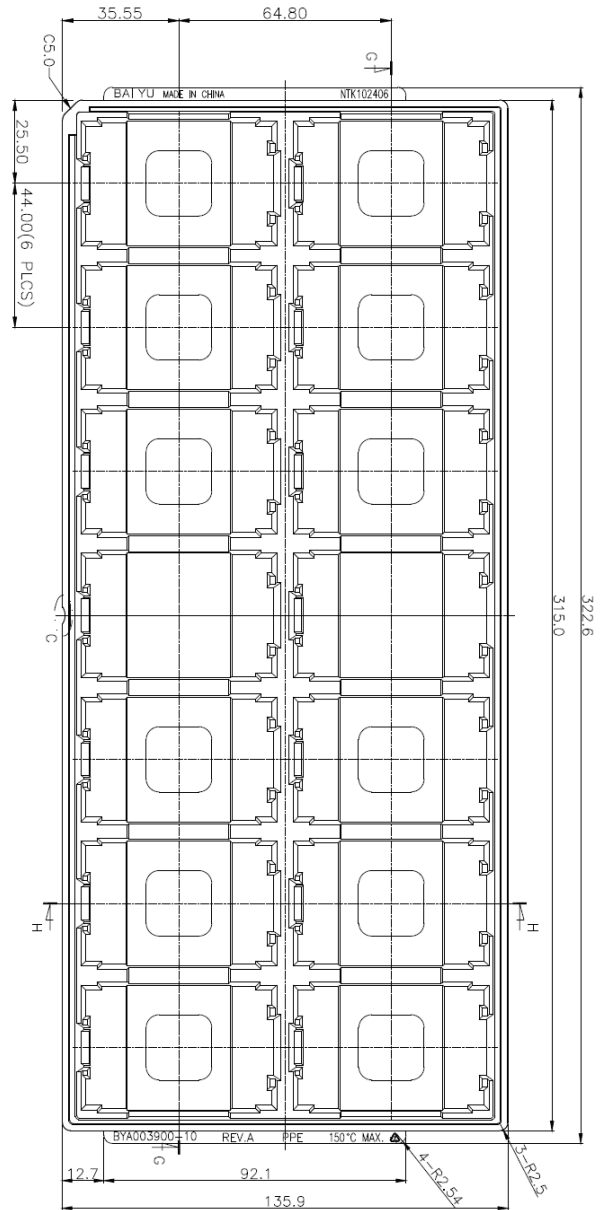

JEDEC standard tray for 2x7 = 14 products.
 All dimensions in mm
 Tolerances: X.x ±0.26 [0.01], X.xx ±0.13 [0.005]
 Note: pick up positions refer to center of pocket.
 See mechanical drawing for exact location on product.

10pcs/tray

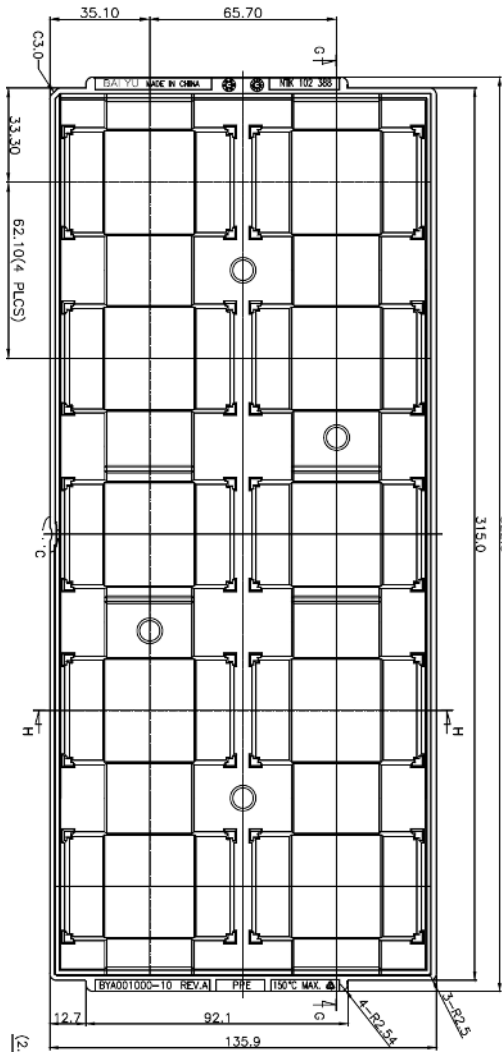

JEDEC standard tray for 2x5 = 10 products.
 All dimensions in mm
 Tolerances: X.x ±0.26 [0.01], X.xx ±0.13 [0.005]
 Note: pick up positions refer to center of pocket.
 See mechanical drawing for exact location on product.

Technical Specification

PKM4613NH Fully regulated DC-DC Converters
 Input 36-75 V, Output up to 50 A / 600 W

28701-BMR669 07 Rev G

June 2023

© Flex

Tray Specifications – Open frame/ Base plate version with dry pack	
Material	Antistatic Polystyrene (black)
Surface resistance	$10^5 < \text{Ohm/square} < 10^{11}$
Bakability	The tray cannot be baked
Tray thickness	25.43 mm 1.0 [inch] – Open frame version 28.0 mm 1.1 [inch] – Base plate version
Box capacity	48 products (4 full trays/box)
Tray weight	704 g full tray – Open frame version 1016 g full tray – Base plate version

Base plate version

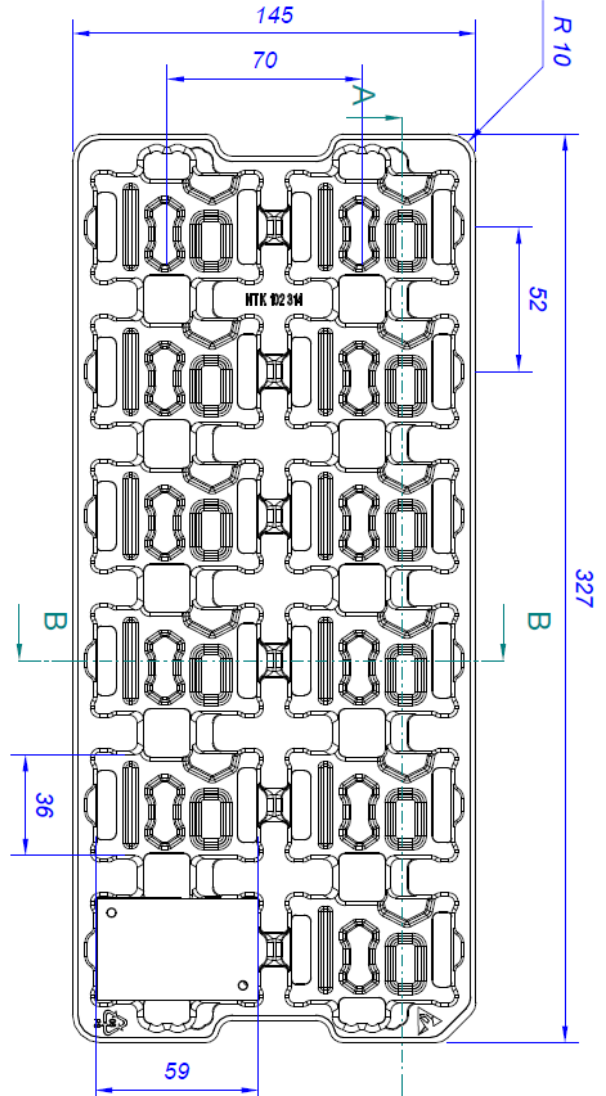

Open frame version

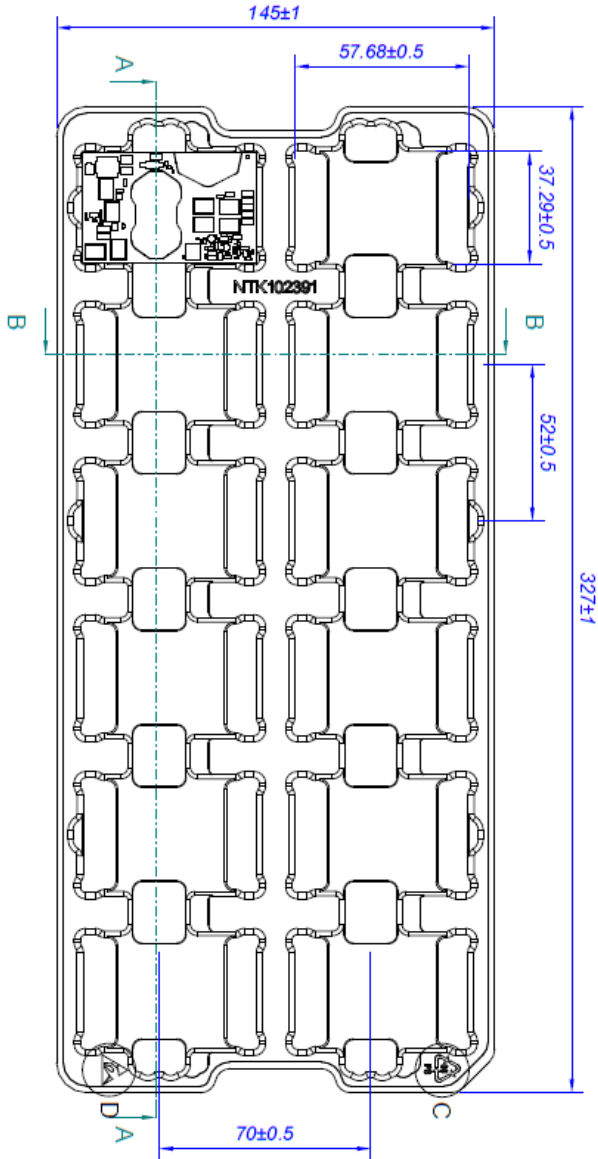

All dimensions in mm [inch]
 Tolerances: X.x ±0.26 [0.01], X.xx ±0.13 [0.005]
 Note: The tray is not designed for machine pick up

Technical Specification

PKM4613NH Fully regulated DC-DC Converters Input 36-75 V, Output up to 50 A / 600 W	28701-BMR669 07 Rev G	June 2023
	© Flex	

Product Qualification Specification

Characteristics			
External visual inspection	IPC-A-610		
Change of temperature (Temperature cycling)	IEC 60068-2-14 Na	Temperature range Number of cycles Dwell/transfer time	-40 to 100°C 1000 15 min/0-1 min
Cold (in operation)	IEC 60068-2-1 Ad	Temperature T _A Duration	-45°C 72 h
Damp heat	IEC 60068-2-67 Cy	Temperature Humidity Duration	85°C 85 % RH 1000 hours
Dry heat	IEC 60068-2-2 Bd	Temperature Duration	125°C 1000 h
Electrostatic discharge susceptibility	IEC 61340-3-1, JESD 22-A114 IEC 61340-3-2, JESD 22-A115	Human body model (HBM) Machine Model (MM)	Class 2, 2000 V Class 3, 200 V
Immersion in cleaning solvents	IEC 60068-2-45 XA, method 2	Water Glycol ether Isopropyl alcohol	55°C 35°C 35°C
Mechanical shock	IEC 60068-2-27 Ea	Peak acceleration Duration	100 g 6 ms
Moisture reflow sensitivity ¹	J-STD-020C	Level 1 (SnPb-eutectic) Level 3 (Pb Free)	225°C 260°C
Operational life test	MIL-STD-202G, method 108A	Duration	1000 h
Resistance to soldering heat ²	IEC 60068-2-20 Tb, method 1A	Solder temperature Duration	270°C 10-13 s
Robustness of terminations	IEC 60068-2-21 Test Ua1 IEC 60068-2-21 Test Ue1	Through hole mount products Surface mount products	All leads All leads
Solderability	IEC 60068-2-58 test Td ¹	Preconditioning Temperature, SnPb Eutectic Temperature, Pb-free	150°C dry bake 16 h 215°C 235°C
	IEC 60068-2-20 test Ta ²	Preconditioning Temperature, SnPb Eutectic Temperature, Pb-free	Steam ageing 235°C 245°C
Vibration, broad band random	IEC 60068-2-64 Fh, method 1	Frequency Spectral density Duration	10 to 500 Hz 0.07 g ² /Hz 10 min in each direction

Notes

¹ Only for products intended for reflow soldering (surface mount products)

² Only for products intended for wave soldering (plated through hole products)