

NOTES: UNLESS OTHERWISE SPECIFIED

1. CONSTRUCTION:
 INSULATOR: MOLDED PVC. AVAILABLE IN BLK & RED
 CONTACT: GOLD PLATED COPPER, NICKEL ALLOY
 SOCKET: TIN PLATED BRASS
2. PERFORMANCE
 MAXIMUM CURRENT: 13 AMPS
 MAXIMUM VOLTAGE: 300 V
 MAXIMUM TEMPERATURE: 122°F (50°C)
3. FEATURES
 REAR SOCKET ACCEPTS STD BAN PLUGS

REVISIONS			
LTR	DESCRIPTION	DATE	APPROVED

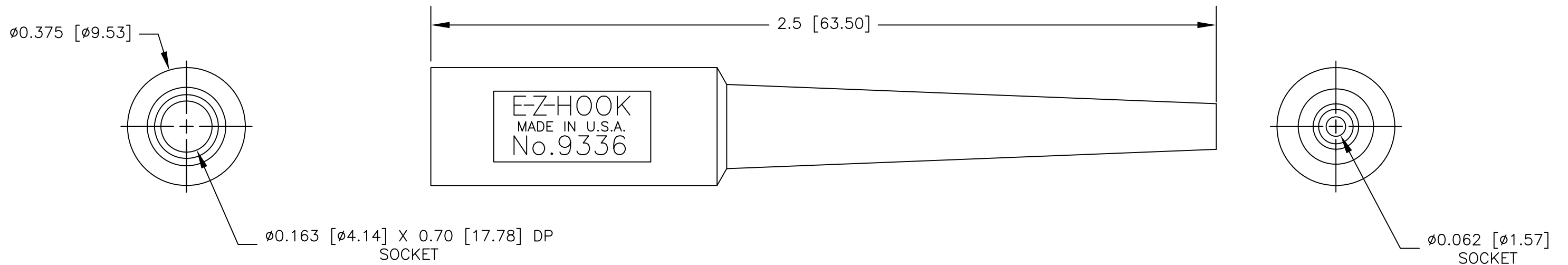

		UNLESS OTHERWISE SPECIFIED DIMENSIONS ARE IN INCHES TOLERANCES ARE: FRACTIONS DECIMALS ANGLES ± .XX ± ± .XXX ±	CONTRACT NO.		E-Z-HOOK DIVISION OF TEKTEST INC. ARCADIA, CA 91006 U.S.A.
			APPROVALS	DATE	
		MATERIAL SEE NOTE.	DRAWN	R.L.	3/15
			APPROVED BY		
NEXT ASSY	USED ON	FINISH SEE NOTE.	SIZE	CODE IDENT NO.	DRAWING NO.
APPLICATION		DO NOT SCALE DRAWING	B	08505	9336
			SCALE	3:1	SHEET 1 OF 1