

# STR-Y6453

## ◆ General Descriptions

The STR-Y6453 is power IC for quasi-resonant switching type power supplies, incorporating a power MOSFET and a controller IC.

The product is automatically switched to the quasi resonant operation, one bottom skip quasi resonant operation and two bottom skip operation in normal operation, and to the burst oscillation operation in light load. That realizes the low standby power and a power supply system with high cost performance, low external part count can be easily composed.

## ◆ Features

### ● Multi operation mode

The operation mode switching with four steps according to load conditions achieves the optimal high efficiency and low noise power supply systems across the full range of loads.

- Current mode control method
- The built-in startup circuit reduces the power consumption
- Auto burst oscillation operation reduces dissipation. Input power  $P_{IN} \leq 0.1W$  at no load
- Standby input compensation
- Overcurrent protection with AC input compensation function
- Built-in soft start function
- Built-in maximum on-time limitation circuit
- Built-in leading edge blanking function
- Avalanche energy guaranteed; two-chip structure (enabling the simplification of surge absorbing circuit)
- Protection functions
  - Overcurrent protection (OCP) with input compensation function: pulse by pulse basis, low dependence on input voltage
  - Overload protection (OLP); latched shutdown or auto restart
  - Overvoltage protection (OVP); latched shutdown

## ◆ Package

Package name: TO-220F-7L (FMS207)

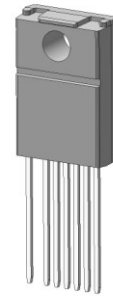

## ◆ Application

Switching Power Supplies for

- Digital appliance such as BD/DVD recorder, FPD TVs, etc.
- OA equipments such as printer
- Home appliance (white goods)
- Industry Machines
- Communication Devices

## ◆ Specification

MOSFET 650V, 1.8Ω(MAX)

## ◆ Typical application circuit

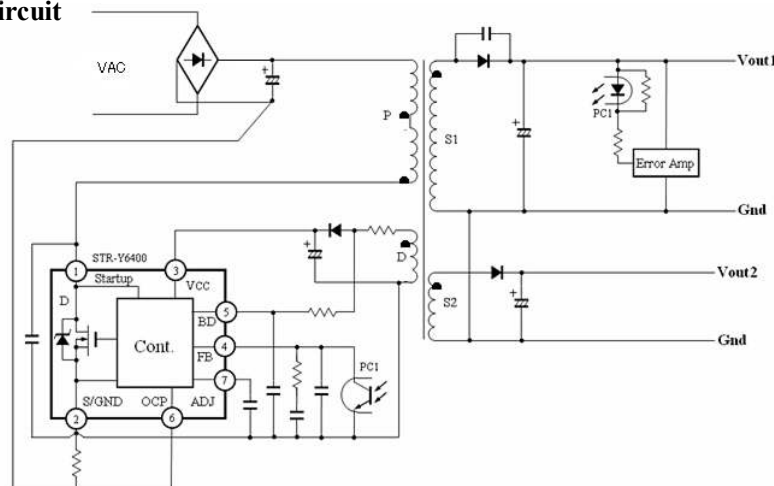

## Absolute maximum ratings

- The polarity value for current specifies a sink as "+," and a source as "-", referencing the IC.
- Unless otherwise specified,  $T_A = 25\text{ }^\circ\text{C}$

Item	Pin	Symbol	Ratings	Unit	Remark
Drain Current	1 – 2	$I_{Dpeak}^{(1)}$	10.7	A	Single pulse
Maximum Switching Current	1 – 2	$I_{DMAX}^{(2)}$	10.2	A	$T_A = -20\text{ to }+125\text{ }^\circ\text{C}$
Avalanche Energy	1 – 2	$E_{AS}^{(3)}$	62	mJ	Single pulse
					$V_{DD}=99\text{V}$ , $L=20\text{mH}$ $I_{Lpeak}=2.3\text{A}$
Control Power Supply Voltage	3 – 2	$V_{CC}$	32	V	
Startup Circuit pin Voltage	1 – 2	$V_{STARTUP}$	$-1.0\text{ to }V_{DSS}$	V	
ADJ pin Inflowing Current	7 – 2	$I_{ADJ}$	3.0	mA	
FB pin Inflowing Current	4 – 2	$I_{FB}$	8.0	mA	
BD pin Inflowing Current	5 – 2	$I_{BDIN}$	2.0	mA	
BD pin Inflowing Current	5 – 2	$I_{BDOUT}$	-2.0	mA	
OCP pin Voltage	6 – 2	$V_{OCP}$	-1.5 to +2.0	V	
MOS FET Power Dissipation	1 – 2	$P_{D1}^{(4)}$	26	W	By infinite radiator
			1.3	W	No radiator
Control Power Dissipation (MIC)	—	$P_{D2}$	0.8	W	
Operating Inner Flame Temperature	—	$T_F$	-20 to +115	$^\circ\text{C}$	Refer to recommended operating temperature
Operating Ambient Temperature	—	Top	-20 to +115	$^\circ\text{C}$	
Storage Temperature	—	Tstg	-40 to +125	$^\circ\text{C}$	
Channel Temperature	—	Tch	+150	$^\circ\text{C}$	

<sup>(1)</sup> Refer to MOS FET A.S.O. curve

<sup>(2)</sup> Regarding the maximum switching current

The maximum switching current is drain current IC determined by inner drive voltage and MOS FET  $V_{th}$ .

<sup>(3)</sup> Refer to MOS FET  $T_{ch}$ - $E_{AS}$  curve

<sup>(4)</sup> Refer to MOS FET  $T_A$ - $P_{D1}$  curve

## Electrical characteristics

### Electrical characteristics for control part

- The polarity value for current specifies a sink as "+," and a source as "-," referencing the IC.
- Unless otherwise specified,  $T_A = 25\text{ }^\circ\text{C}$ ,  $V_{CC} = 20\text{V}$

Characteristic	Pins	Symbol	Rating			Unit
			MIN	TYP	MAX	
<b>Power Supply Startup Operation</b>						
Operation Start Voltage	3 - 2	$V_{CC(ON)}$	14.4	16.2	18.4	V
Operation Stop voltage	3 - 2	$V_{CC(OFF)}$	9.0	10.0	11.3	V
Circuit Current in Operation	3 - 2	$I_{CC(ON)}$	—	3.5	5.5	mA
Circuit Current in Non-Operation	3 - 2	$I_{CC(OFF)}$	—	10	50	$\mu\text{A}$
Startup Circuit Operation Voltage	1 - 2	$V_{START(ON)}$	55	82	100	V
Startup Current	3 - 2	$I_{CC(STARTUP)}$	-2.4	-1.4	-0.5	mA
Startup Current after OLP Operation	3 - 2	$I_{CC(STARTOLP)}$	-1.10	-0.50	-0.15	mA
Oscillation Frequency	1 - 2	$f_{OSC}$	17.5	21.0	25.0	kHz
Soft Start Operation Stop Voltage	7 - 2	$V_{ADJ(SS)}$	2.0	2.3	2.6	V
Soft Start Operation Charging Current	7 - 2	$I_{ADJ(SS)}$	-148	-110	-71	$\mu\text{A}$
Power Off Threshold Voltage	7 - 2	$V_{ADJ(OFF)}$	8.2	9.4	10.8	V
<b>Normal Operation</b>						
Bottom-Skip Operation Threshold Voltage 1	6 - 2	$V_{OCP(BS1)}$	-0.720	-0.668	-0.605	V
Bottom-Skip Operation Threshold Voltage 2	6 - 2	$V_{OCP(BS2)}$	-0.485	-0.435	-0.381	V
Bottom-Skip Operation Threshold Voltage 3	6 - 2	$V_{OCP(BS3)}$	-0.205	-0.145	-0.085	V
Bottom-Skip Start Voltage	7 - 2	$V_{ADJ(BS)}$	3.8	4.3	4.8	V
Bottom-Skip Detection Bias Current	7 - 2	$I_{ADJ(BS)}$	-27	-20	-13	$\mu\text{A}$
BD Pin Maximum Clamp Voltage	5 - 2	$V_{BD(HC)}$	—	6.3	—	V
BD Pin Minimum Clamp Voltage	5 - 2	$V_{BD(LC)}$	—	-0.075	—	V
Quasi-Resonant Operation Threshold Voltage 1	5 - 2	$V_{BD(TH1)}$	0.12	0.31	0.60	V
Quasi-Resonant Operation Threshold Voltage 2	5 - 2	$V_{BD(TH2)}$	0.01	0.15	0.32	V
Maximum Feedback Current	4 - 2	$I_{FB(MAX)}$	-315	-225	-135	$\mu\text{A}$
<b>Standby Operation</b>						
Standby State Detection Voltage	4 - 2	$V_{FB(STBIN)}$	1.40	1.63	1.85	V
Standby State Start Voltage	7 - 2	$V_{ADJ(STB)}$	5.7	6.2	6.8	V
Standby Operation Voltage	4 - 2	$V_{FB(STBOP)}$	0.80	1.00	1.25	V
Minimum ON-time (in steady state)	1 - 2	$t_{ONL(MIN)}$	1.00	1.64	2.23	$\mu\text{s}$
Minimum ON-time (in input compensation)	1 - 2	$t_{ONH(MIN)}$	0.56	1.00	1.44	$\mu\text{s}$

Characteristic	Pins	Symbol	Rating			Unit
			MIN	TYP	MAX	
<b>Protection Operation</b>						
Maximum ON-time	1 - 2	$t_{ON(MAX)}$	31	36	41	$\mu s$
Leading Edge Blanking Time	1 - 2	$t_{ON(LEB)}$	—	388	—	ns
Overcurrent Detection Threshold Voltage (in steady state)	6 - 2	$V_{OCP(H)}$	-0.975	-0.930	-0.875	V
Overcurrent Detection Threshold Voltage (in input compensation)	6 - 2	$V_{OCP(L)}$	-0.904	-0.780	-0.656	V
OCP Pin Leakage Current	6 - 2	$I_{OCP(O)}$	-260	-130	-40	$\mu A$
Input Compensation Detection Threshold Current 1	5 - 2	$I_{BD(TH1)}$	-575	-500	-425	$\mu A$
Input Compensation Detection Threshold Current 2	5 - 2	$I_{BD(TH2)}$	-565	-450	-375	$\mu A$
OLP Bias Current	4 - 2	$I_{FB(OLP)}$	-27	-20	-13	$\mu A$
OLP Auto Restart Threshold Voltage	4 - 2	$V_{FB(OLPAUTO)}$	6.3	6.7	7.3	V
OLP Latched Shutoff Bias Current	4 - 2	$I_{FB(OLPLa.OFF)}$	-1.5	-1.0	-0.5	mA
OLP Latched Shutoff Threshold Voltage	4 - 2	$V_{FB(OLPLa.OFF)}$	8.6	9.6	10.2	V
OVP Operation Power Supply Voltage	3 - 2	$V_{CC(OVP)}$	26.0	28.5	31.0	V
Latch Circuit Release Power Supply Voltage *	3 - 2	$V_{CC(La.OFF)}$	6.2	7.5	8.9	V
Maximum Voltage in Feedback Control	4 - 2	$V_{FB(MAX)}$	4.90	5.45	6.00	V
Thermal shutdown operation temperature	—	$T_{J(TSD)}$	135	—	—	$^{\circ}C$

\* The latch circuit means a circuit operated by OVP or OLP.

## Electrical characteristics for MOSFET part

• Unless otherwise specified,  $T_A = 25^{\circ}C$ ,

Characteristic	Pins	Symbol	Rating			Unit
			MIN	TYP	MAX	
Voltage between Drain and Source	1 - 2	$V_{DSS}$	650	—	—	V
Drain Leakage Current	1 - 2	$I_{DSS}$	—	—	300	$\mu A$
ON Resistance	1 - 2	$R_{DS(ON)}$	—	—	1.8	$\Omega$
Switching Time	1 - 2	$t_f$	—	—	500	ns
Thermal Resistance*	—	$\theta_{ch-F}$	—	1.0	2.0	$^{\circ}C/W$

\*Between Channel and inner frame

# STR-Y6453

Sep, 2013

STR-Y6453

A.S.O.温度デレーティング係数曲線  
A.S.O. temperature derating coefficient curve

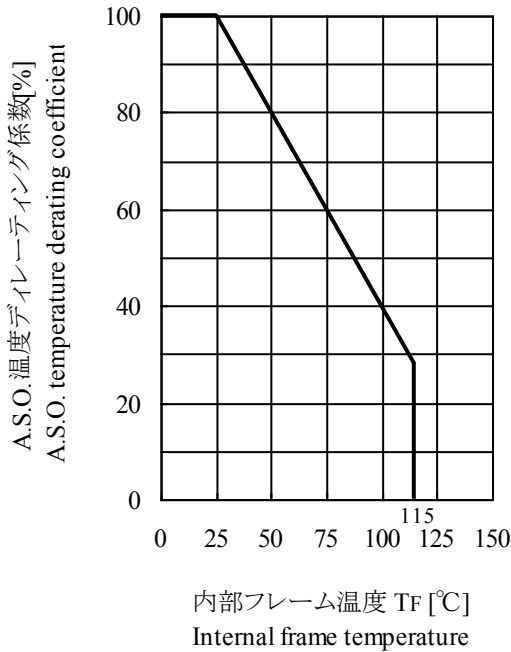

STR-Y6453  
MOS FET A.S.O. 曲線 Ta=25°C  
curve

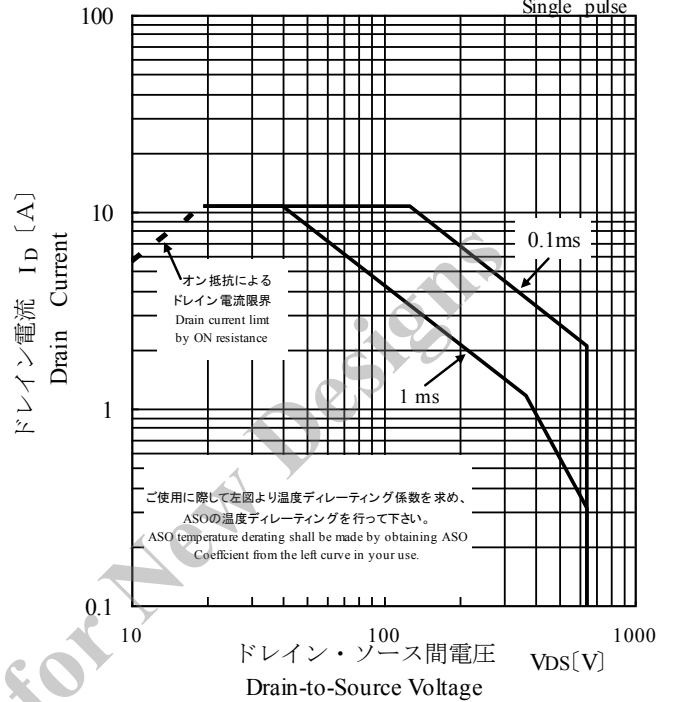

STR-Y6453  
MOSFET Ta-Pd1 曲線  
curve

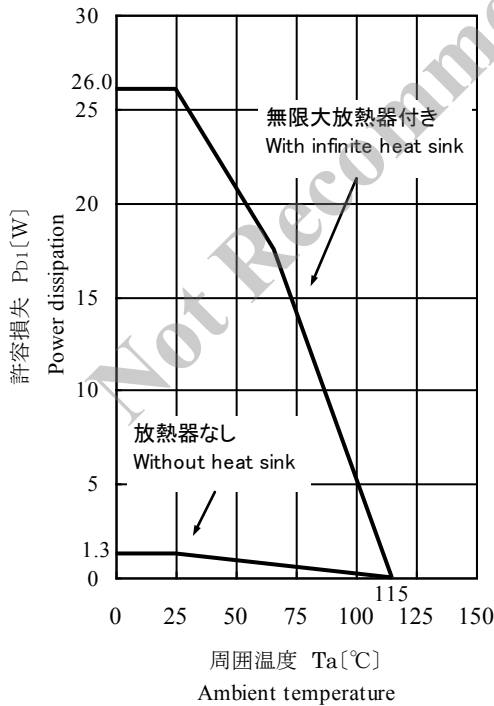

STR-Y6453  
アバランシェ・エネルギー耐量  
デレーティング曲線  
Avalanche energy derating curve

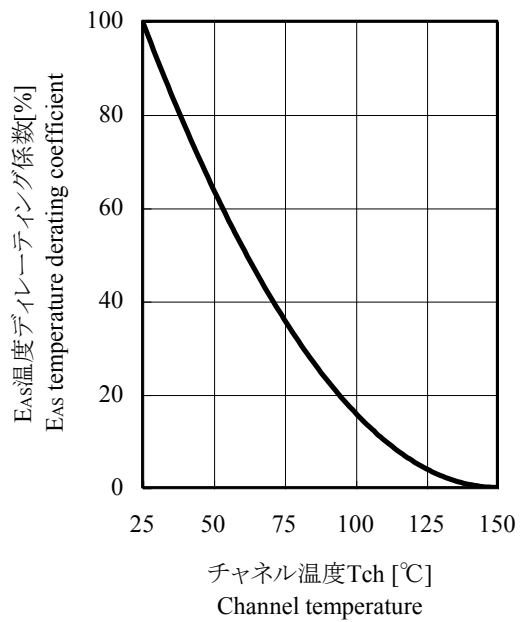

# STR-Y6453

STR-Y6453 過渡熱抵抗曲線  
STR-Y6453 Transient thermal resistance curve

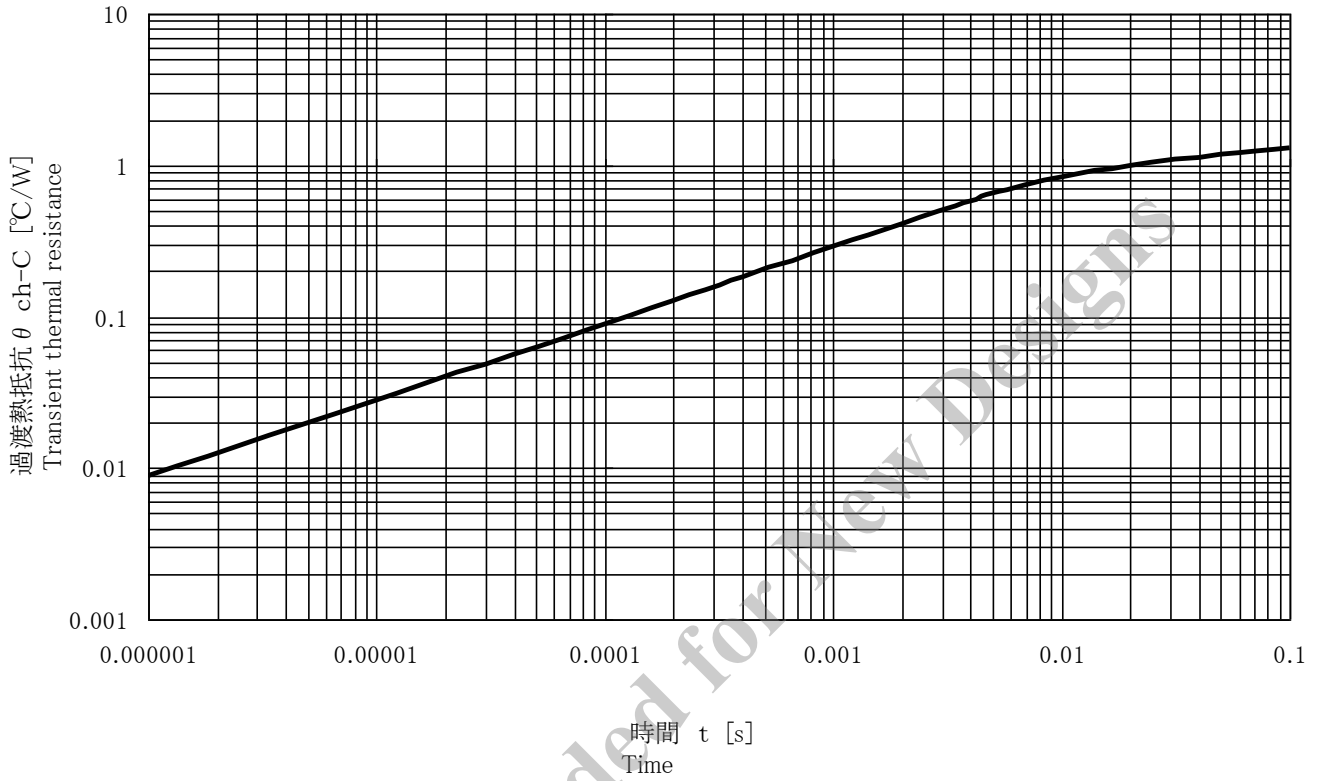

# STR-Y6453

## Black Diagram

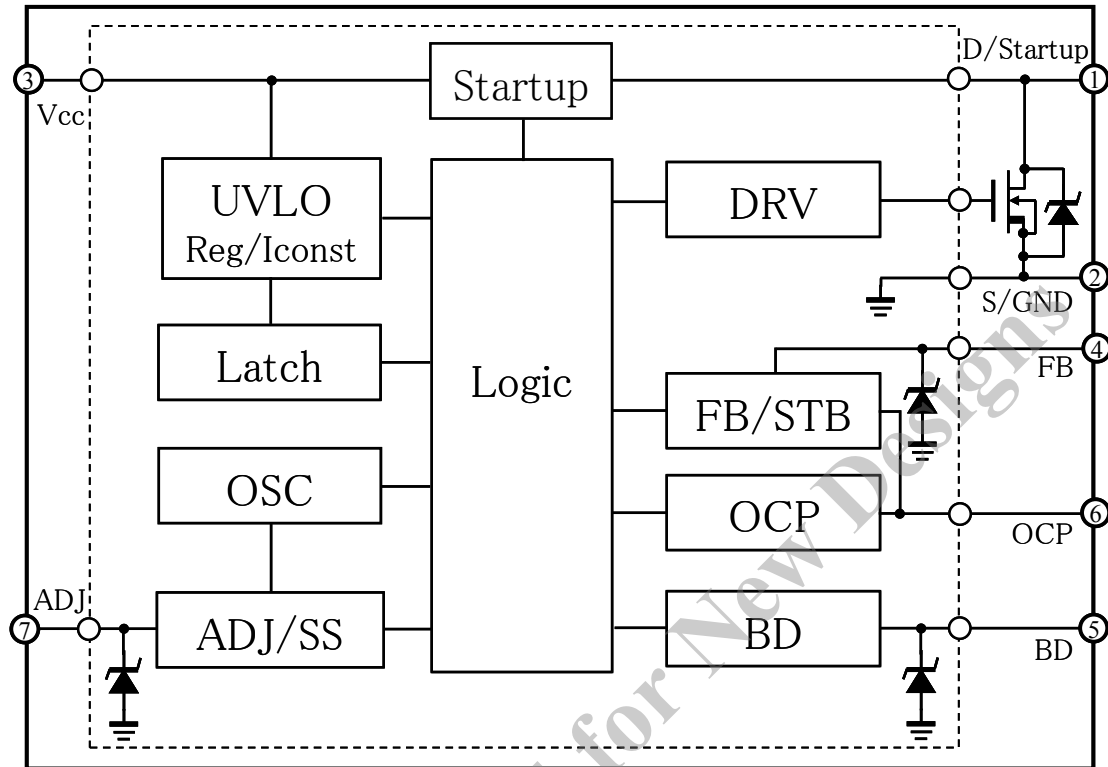

## Pin function description

Pin No.	Symbol	Name	Function
1	D/Startup	Drain / Startup circuit input pin	MOSFET drain and startup circuit input
2	S/GND	Source/ Ground pin	MOSFET source and ground
3	V <sub>CC</sub>	Power Supply pin	Input for power supply for control circuit
4	FB	Feedback pin	Input for Constant voltage control signal/ Standby control/ Over load detection signal
5	BD	Bottom detection/ Input compensation detection pin	Input for bottom detection signal/ Input compensation detection signal
6	OCP	Overcurrent protection input pin	Input for Overcurrent detection signal/ Bottom skip signal detection signal
7	ADJ	Adjust pin	Soft start operation/ Delay time setting of bottom skip / Input for remote ON/OFF signal

# STR-Y6453

## Typical Application Circuit

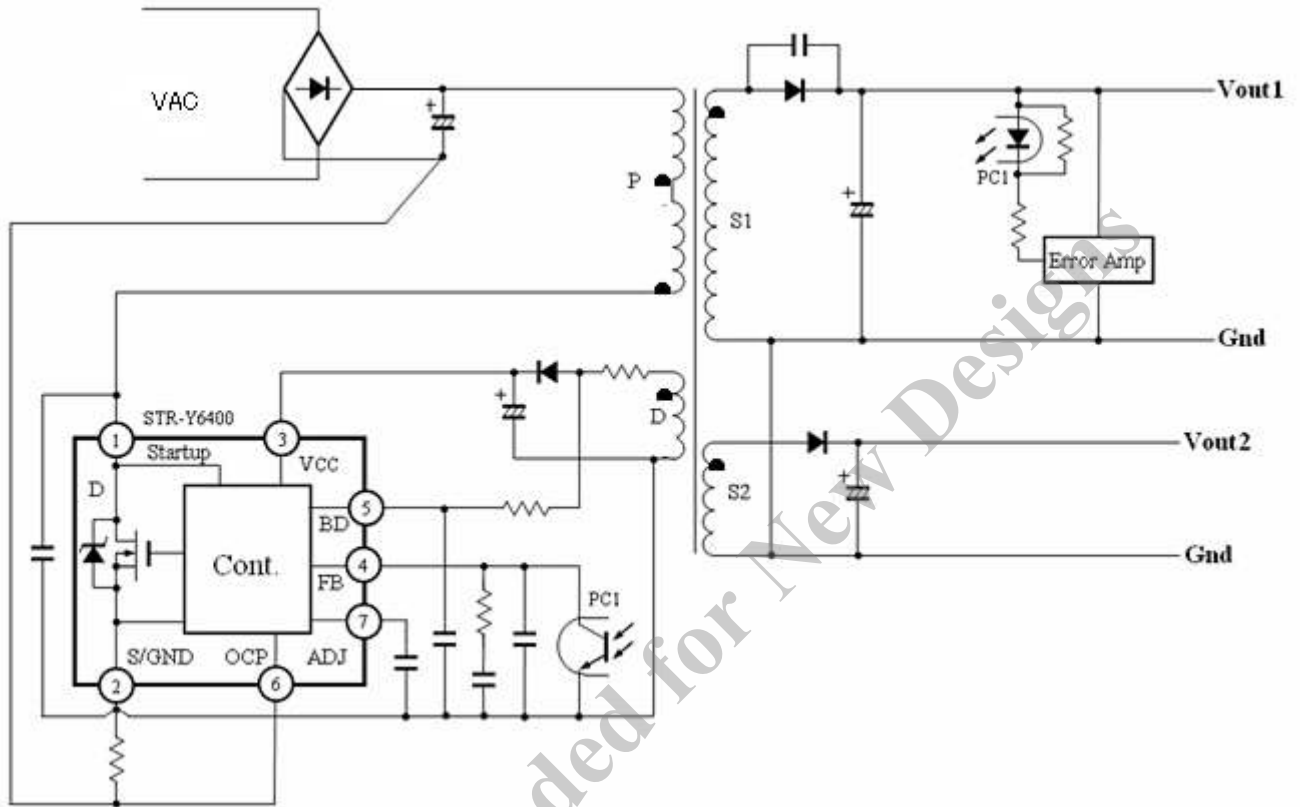



# STR-Y6453

## Package

Lead forming

No. 3001

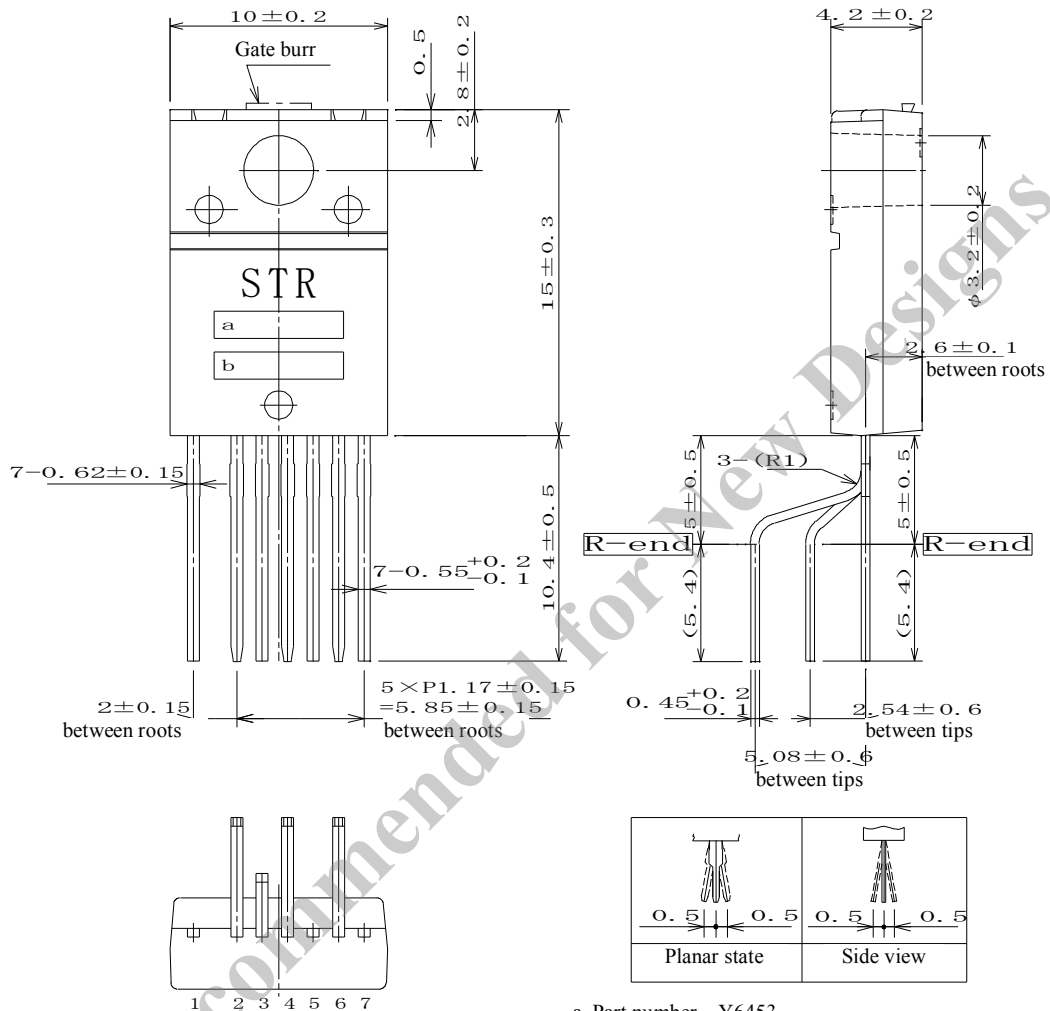

Pin material: Cu  
Pin treatment: Ni plating and solder dip  
Product weight (approximate): 2.3g

Note  
— part shows the point gate burr (height 0.3 max) occurred  
Dimensions in millimeters

a. Part number Y6453  
b. Lot number

1<sup>st</sup> letter: The Last digit of year  
2<sup>nd</sup> letter: Month  
Jan. to Sep. Arabic number  
Oct. O  
Nov. N  
Dec. D

3<sup>rd</sup> & 4<sup>th</sup> letter: day  
01-31 Arabic numbers  
5<sup>th</sup> letter: Sanken management symbol

## OPERATING PRECAUTIONS

In the case that you use Sanken products or design your products by using Sanken products, the reliability largely depends on the degree of derating to be made to the rated values. Derating may be interpreted as a case that an operation range is set by derating the load from each rated value or surge voltage or noise is considered for derating in order to assure or improve the reliability. In general, derating factors include electric stresses such as electric voltage, electric current, electric power etc., environmental stresses such as ambient temperature, humidity etc. and thermal stress caused due to self-heating of semiconductor products. For these stresses, instantaneous values, maximum values and minimum values must be taken into consideration. In addition, it should be noted that since power devices or IC's including power devices have large self-heating value, the degree of derating of junction temperature affects the reliability significantly.

Because reliability can be affected adversely by improper storage environments and handling methods, please observe the following cautions.

### Cautions for Storage

- Ensure that storage conditions comply with the standard temperature (5 to 35°C) and the standard relative humidity (around 40 to 75%); avoid storage locations that experience extreme changes in temperature or humidity.
- Avoid locations where dust or harmful gases are present and avoid direct sunlight.
- Reinspect for rust on leads and solderability of the products that have been stored for a long time.

### Cautions for Testing and Handling

When tests are carried out during inspection testing and other standard test periods, protect the products from power surges from the testing device, shorts between the product pins, and wrong connections. Ensure all test parameters are within the ratings specified by Sanken for the products.

### Remarks About Using Silicone Grease with a Heatsink

- When silicone grease is used in mounting the products on a heatsink, it shall be applied evenly and thinly. If more silicone grease than required is applied, it may produce excess stress.
- Volatile-type silicone greases may crack after long periods of time, resulting in reduced heat radiation effect. Silicone greases with low consistency (hard grease) may cause cracks in the mold resin when screwing the products to a heatsink. Our recommended silicone greases for heat radiation purposes, which will not cause any adverse effect on the product life, are indicated below:

Type	Suppliers
G746	Shin-Etsu Chemical Co., Ltd.
YG6260	Momentive Performance Materials Inc.
SC102	Dow Corning Toray Co., Ltd.

### Cautions for Mounting to a Heatsink

- When the flatness around the screw hole is insufficient, such as when mounting the products to a heatsink that has an extruded (burred) screw hole, the products can be damaged, even with a lower than recommended screw torque. For mounting the products, the mounting surface flatness should be 0.05mm or less.
- Please select suitable screws for the product shape. Do not use a flat-head machine screw because of the stress to the products. Self-tapping screws are not recommended. When using self-tapping screws, the screw may enter the hole diagonally, not vertically, depending on the conditions of hole before threading or the work situation. That may stress the products and may cause failures.
- Recommended screw torque: 0.588 to 0.785 N·m (6 to 8 kgf·cm).
- For tightening screws, if a tightening tool (such as a driver) hits the products, the package may crack, and internal stress fractures may occur, which shorten the lifetime of the electrical elements and can cause catastrophic failure. Tightening with an air driver makes a substantial impact. In addition, a screw torque higher than the set torque can be applied and the package may be damaged. Therefore, an electric driver is recommended.

When the package is tightened at two or more places, first pre-tighten with a lower torque at all places, then tighten with the specified torque. When using a power driver, torque control is mandatory.

### Soldering

- When soldering the products, please be sure to minimize the working time, within the following limits:
  - 260 ± 5 °C 10 ± 1 s (Flow, 2 times)
  - 380 ± 10 °C 3.5 ± 0.5 s (Soldering iron, 1 time)
- Soldering should be at a distance of at least 1.5 mm from the body of the products.

## Electrostatic Discharge

- When handling the products, the operator must be grounded. Grounded wrist straps worn should have at least  $1M\Omega$  of resistance from the operator to ground to prevent shock hazard, and it should be placed near the operator.
- Workbenches where the products are handled should be grounded and be provided with conductive table and floor mats.
- When using measuring equipment such as a curve tracer, the equipment should be grounded.
- When soldering the products, the head of soldering irons or the solder bath must be grounded in order to prevent leak voltages generated by them from being applied to the products.
- The products should always be stored and transported in Sanken shipping containers or conductive containers, or be wrapped in aluminum foil.

## IMPORTANT NOTES

- The contents in this document are subject to changes, for improvement and other purposes, without notice. Make sure that this is the latest revision of the document before use.
- Application and operation examples described in this document are quoted for the sole purpose of reference for the use of the products herein and Sanken can assume no responsibility for any infringement of industrial property rights, intellectual property rights or any other rights of Sanken or any third party which may result from its use. Unless otherwise agreed in writing by Sanken, Sanken makes no warranties of any kind, whether express or implied, as to the products, including product merchantability, and fitness for a particular purpose and special environment, and the information, including its accuracy, usefulness, and reliability, included in this document.
- Although Sanken undertakes to enhance the quality and reliability of its products, the occurrence of failure and defect of semiconductor products at a certain rate is inevitable. Users of Sanken products are requested to take, at their own risk, preventative measures including safety design of the equipment or systems against any possible injury, death, fires or damages to the society due to device failure or malfunction.
- Sanken products listed in this document are designed and intended for the use as components in general purpose electronic equipment or apparatus (home appliances, office equipment, telecommunication equipment, measuring equipment, etc.).  
When considering the use of Sanken products in the applications where higher reliability is required (transportation equipment and its control systems, traffic signal control systems or equipment, fire/crime alarm systems, various safety devices, etc.), and whenever long life expectancy is required even in general purpose electronic equipment or apparatus, please contact your nearest Sanken sales representative to discuss, prior to the use of the products herein.  
The use of Sanken products without the written consent of Sanken in the applications where extremely high reliability is required (aerospace equipment, nuclear power control systems, life support systems, etc.) is strictly prohibited.
- When using the products specified herein by either (i) combining other products or materials therewith or (ii) physically, chemically or otherwise processing or treating the products, please duly consider all possible risks that may result from all such uses in advance and proceed therewith at your own responsibility.
- Anti radioactive ray design is not considered for the products listed herein.
- Sanken assumes no responsibility for any troubles, such as dropping products caused during transportation out of Sanken's distribution network.
- The contents in this document must not be transcribed or copied without Sanken's written consent.