

3 LEAD BICOLOR T-1 3/4 (5 mm) SOLID STATE LAMPS

PACKAGE DIMENSIONS

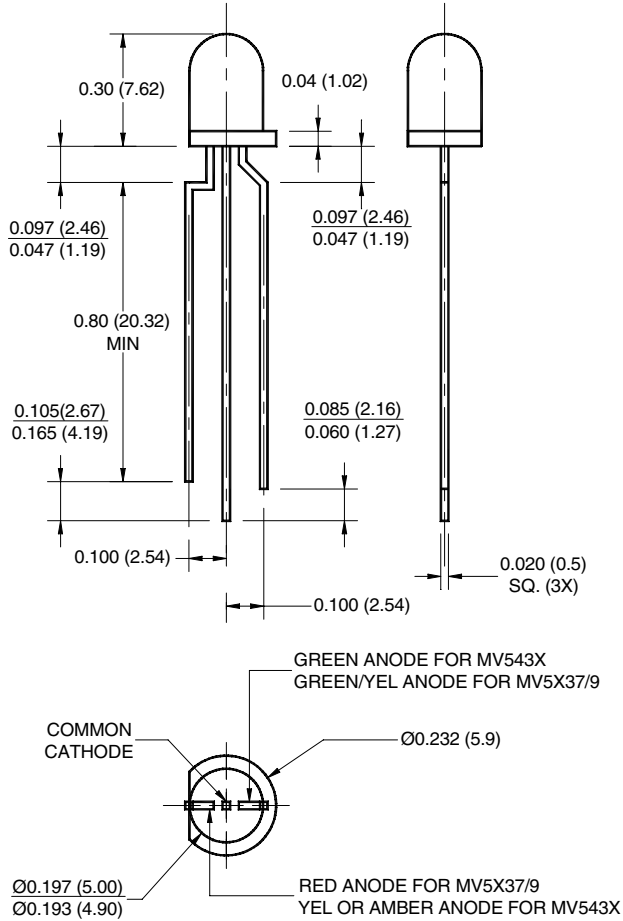

NOTES:

1. Dimensions for all drawings are in inches (mm).
2. Tolerance is $\pm 0.12''$ unless otherwise specified.

| | |
|--------------------|--------|
| GREEN / YELLOW | MV5433 |
| GREEN / ORANGE | MV5438 |
| YELLOW / HER | MV5337 |
| GREEN / HER | MV5437 |
| GREEN / AlGaAs RED | MV5439 |

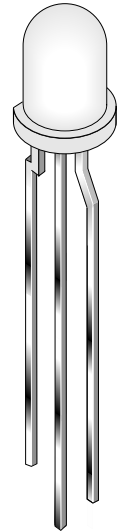

FEATURES

- Popular T-1 3/4 package
- Wide viewing angle
- Solid state reliability
- TTL compatible

DESCRIPTION

The MV5X3X T-1 3/4 (5 mm) lamp is a three-lead bicolor light source with a central common cathode lead. Each lamp comes with a white diffused lens and has a 100° viewing angle.

ABSOLUTE MAXIMUM RATINGS ($T_A = 25^\circ\text{C}$ unless otherwise specified)

| Parameter | AlGaAs RED | HER | Green | Yellow | Orange | Units |
|--|---------------|-----|-------|--------|--------|------------------|
| Continuous Forward Current (I_F) | 30 | 30 | 30 | 20 | 30 | mA |
| Peak Forward Current (I_F) ($f = 1.0$ KHz, Duty Factor = 1/10) | 90 | 90 | 90 | 60 | 90 | mA |
| Power Dissipation (P_D) | 120 | 120 | 120 | 85 | 100 | mW |
| Reverse Voltage (V_R) | 5 | 5 | 5 | 5 | 5 | V |
| Operating Temperature (T_{OPR}) | -55 to +100 | | | | | $^\circ\text{C}$ |
| Storage Temperature (T_{STG}) | -55 to +100 | | | | | $^\circ\text{C}$ |
| Lead Soldering Time (T_{SOL}) | 260 for 5 sec | | | | | $^\circ\text{C}$ |

| | |
|--------------------|--------|
| GREEN / YELLOW | MV5433 |
| GREEN / ORANGE | MV5438 |
| YELLOW / HER | MV5337 |
| GREEN / HER | MV5437 |
| GREEN / AlGaAs RED | MV5439 |

ELECTRICAL / OPTICAL CHARACTERISTICS (T_A = 25°C)

| Part Number | MV5437 Grn/HER | MV5337 Yel/HER | MV5433 Grn/Yel | MV5438 Grn/Orange | MV5439 Grn/AlGaAs Red | Condition |
|-------------------------------|-------------------|-------------------|-------------------|----------------------|--------------------------|------------------------|
| Luminous Intensity (mcd) | | | | | | I _F = 20 mA |
| Minimum | 2/2 | 2/2 | 2/2 | 2/2 | 2/10 | |
| Typical | 6/6 | 6/6 | 6/6 | 6/6 | 6/25 | |
| Forward Voltage (V) | | | | | | I _F = 20 mA |
| Maximum | 3.0/3.0 | 3.0/3.0 | 3.0/3.0 | 3.0/3.0 | 3.0/2.4 | |
| Typical | 2.1/2.1 | 2.1/2.1 | 2.3/2.3 | 2.3/2.3 | 2.3/1.7 | |
| Peak Wavelength (nm) | 565/635 | 585/635 | 565/585 | 565/610 | 565/660 | I _F = 20 mA |
| Spectral Line Half Width (nm) | 30/45 | 35/45 | 30/35 | 30/40 | 30/20 | I _F = 20 mA |
| Viewing Angle (°) | 100° | 100° | 100° | 100° | 100° | I _F = 20 mA |

TYPICAL PERFORMANCE CURVES

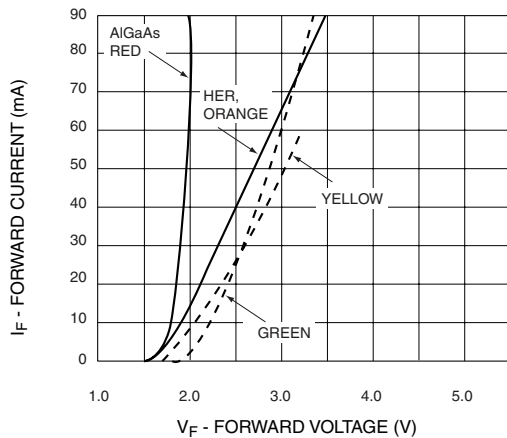

Fig. 1 Forward Current vs. Forward Voltage

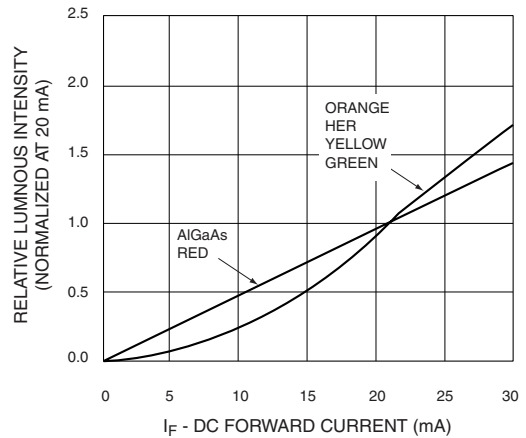

Fig. 2 Relative Luminous Intensity vs. DC Forward Current

3 LEAD BICOLOR T-1 3/4 (5 mm) SOLID STATE LAMPS

| | |
|--------------------|--------|
| GREEN / YELLOW | MV5433 |
| GREEN / ORANGE | MV5438 |
| YELLOW / HER | MV5337 |
| GREEN / HER | MV5437 |
| GREEN / AlGaAs RED | MV5439 |

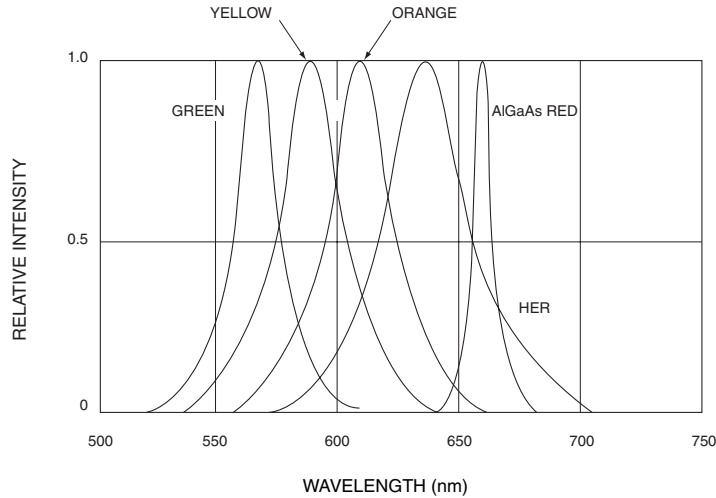

Fig. 3 Relative Intensity vs. Peak Wavelength

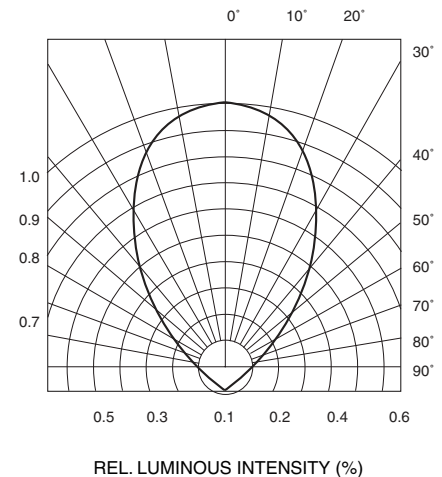

Fig. 4 Radiation Diagram

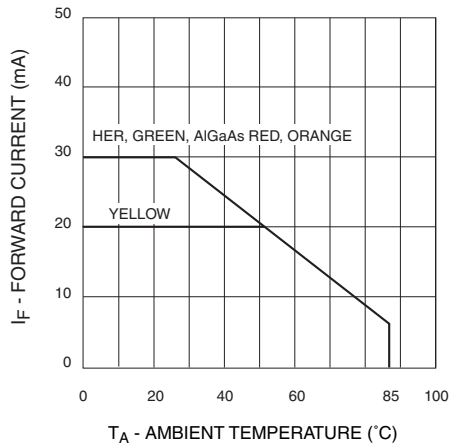

Fig. 5 Current Derating Curve

| | |
|---------------------------|---------------|
| GREEN / YELLOW | MV5433 |
| GREEN / ORANGE | MV5438 |
| YELLOW / HER | MV5337 |
| GREEN / HER | MV5437 |
| GREEN / AlGaAs RED | MV5439 |

DISCLAIMER

FAIRCHILD SEMICONDUCTOR RESERVES THE RIGHT TO MAKE CHANGES WITHOUT FURTHER NOTICE TO ANY PRODUCTS HEREIN TO IMPROVE RELIABILITY, FUNCTION OR DESIGN. FAIRCHILD DOES NOT ASSUME ANY LIABILITY ARISING OUT OF THE APPLICATION OR USE OF ANY PRODUCT OR CIRCUIT DESCRIBED HEREIN; NEITHER DOES IT CONVEY ANY LICENSE UNDER ITS PATENT RIGHTS, NOR THE RIGHTS OF OTHERS.

LIFE SUPPORT POLICY

FAIRCHILD'S PRODUCTS ARE NOT AUTHORIZED FOR USE AS CRITICAL COMPONENTS IN LIFE SUPPORT DEVICES OR SYSTEMS WITHOUT THE EXPRESS WRITTEN APPROVAL OF THE PRESIDENT OF FAIRCHILD SEMICONDUCTOR CORPORATION. As used herein:

1. Life support devices or systems are devices or systems which, (a) are intended for surgical implant into the body, or (b) support or sustain life, and (c) whose failure to perform when properly used in accordance with instructions for use provided in labeling, can be reasonably expected to result in a significant injury of the user.
2. A critical component in any component of a life support device or system whose failure to perform can be reasonably expected to cause the failure of the life support device or system, or to affect its safety or effectiveness.