

2333393-3 ✓ ACTIVE



zQSFP+/QSFP28

TE Internal #: 2333393-3

QSFP28 Cable Assembly, 16 Positions, 3.28 ft [1 m], 25 Gb/s, Black Cable, Shielded, 30 AWG, .051 mm², Madison TurboTwin - Round Jacketed, QSFP28 Plug

[View on TE.com >](#)

Cable Assemblies > Copper Cable Assemblies > Pluggable I/O Cable Assemblies > QSFP28 to QSFP28 Cable Assembly: 30 AWG

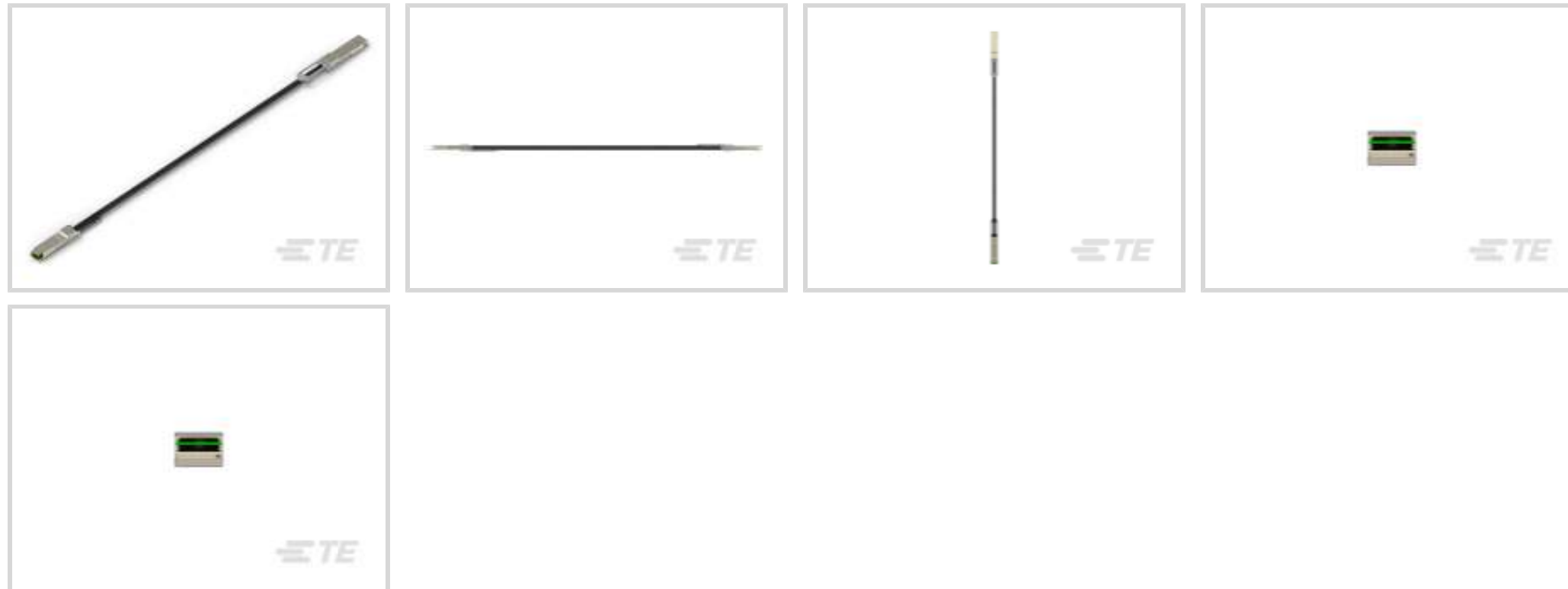

Cable Assembly Type: **QSFP28**

Equalized: **No**

Wire Size: **.051 mm²**

Outside Cable Diameter: **6.2 mm [.244 in]**

[All QSFP28 to QSFP28 Cable Assembly: 30 AWG \(6\)](#)

Features

Product Type Features

Cable Assembly Category	High Speed, Industry Standard
Cable Assembly Type	QSFP28
Connector Type (End A)	QSFP28 Plug
Connector Type (End B)	QSFP28 Plug
Cable Style	Madison TurboTwin - Round Jacketed

Configuration Features

Number of Positions	16
Number of Pairs	8
Number of Signal Positions	16

Electrical Characteristics

Impedance	100 Ω
-----------	-------

Signal Characteristics

Data Rate	25 Gb/s
-----------	---------



Body Features

Equalized	No
Cable Color	Black
Cable Flammability Rating	CL2

Dimensions

Wire Size	.051 mm ²
Outside Cable Diameter	6.2 mm[.244 in]

Operation/Application

Shielded	Yes
Halogen Free	No

Other

Cable Assembly Configuration	Double Ended
Cable Assembly Length	1 m[3.28 ft]

Product Compliance

[For compliance documentation, visit the product page on TE.com>](#)

EU RoHS Directive 2011/65/EU	Compliant with Exemptions
EU ELV Directive 2000/53/EC	Not Compliant
China RoHS 2 Directive MIIT Order No 32, 2016	Restricted Materials Above Threshold
EU REACH Regulation (EC) No. 1907/2006	Current ECHA Candidate List: JUNE 2023 (235) Candidate List Declared Against: JAN 2022 (223) Does not contain REACH SVHC
Halogen Content	Not Low Halogen - contains Br or Cl > 900 ppm.
Solder Process Capability	Not reviewed for solder process capability

Product Compliance Disclaimer

This information is provided based on reasonable inquiry of our suppliers and represents our current actual knowledge based on the information they provided. This information is subject to change. The part numbers that TE has identified as EU RoHS compliant have a maximum concentration of 0.1% by weight in homogenous materials for lead, hexavalent chromium, mercury, PBB, PBDE, DBP, BBP, DEHP, DIBP, and 0.01% for cadmium, or qualify for an exemption to these limits as defined in the Annexes of Directive 2011/65/EU (RoHS2). Finished electrical and electronic equipment products will be CE marked as required by Directive 2011/65/EU. Components may not be CE marked. Additionally, the part numbers that TE has identified as EU ELV compliant have a maximum concentration of 0.1% by weight in homogenous materials for lead, hexavalent chromium, and mercury, and 0.01% for cadmium, or qualify for an exemption to these limits as defined in the Annexes of Directive 2000/53/EC (ELV). Regarding the REACH Regulation, the information TE provides

on SVHC in articles for this part number is based on the latest European Chemicals Agency (ECHA) 'Guidance on requirements for substances in articles' posted at this URL: <https://echa.europa.eu/guidance-documents/guidance-on-reach>

Compatible Parts



TE Part # 2170705-7
CAGE ASSY, QSFP28 1X1, SPRING, HS, LP



TE Part # 2-2170747-2
CAGE ASSY, 1X4, QSFP28, SPRING, HS, LP



TE Part # 2170704-2
CAGE ASSY, QSFP28 1X1, SPRING, HS, LP



TE Part # 2227103-2
1X2 CAGE ASSY BHND BZL QSFP28



TE Part # 2170707-3
CAGE ASSY, 1X6, QSFP28, SPRING, HS



TE Part # 2227103-1
1X2 CAGE ASSY BHND BZL QSFP28 HS



TE Part # 2170704-1
CAGE ASSY, QSFP28 1X1, SPRING, HS



TE Part # 2170704-5
CAGE ASSY, QSFP28 1X1, SPRING, HS



TE Part # 1551892-1
Cage Assy Behind Bezel QSFP28



TE Part # 2227104-1
1X2 CAGE ASSY, BHND BEZEL, QSFP28



TE Part # 2170703-7
CAGE ASSEMBLY, QSFP28 1X1, SPRING



TE Part # 2170790-4
CAGE ASSY, 1X4, QSFP28, SPRING, HS, LP



TE Part # 2170703-6
CAGE ASSEMBLY, QSFP28 1X1, SPRING



TE Part # 1551891-1
Cage Assy, Behind Bezel, QSFP28



TE Part # 1551920-1
zQSFP+ connector assembly



TE Part # 2-2170808-3
QSFP28, 1X2, CAGE ASSY, SPRING, HS, LP



TE Part # 2170704-4
CAGE ASSY, QSFP28 1X1, SPRING, HS



TE Part # 2170806-2
CAGE ASSEMBLY, 1X2, QSFP28, SPRING, HS



TE Part # 2170806-3
CAGE ASSEMBLY, 1X2, QSFP28, SPRING, HS



TE Part # 2170806-4
CAGE ASSEMBLY, 1X2, QSFP28, SPRING, HS

Also in the Series | **zQSFP+/QSFP28**



Pluggable I/O Cable Assemblies(81)



QSFP, QSFP+ & zQSPF+(432)

Customers Also Bought

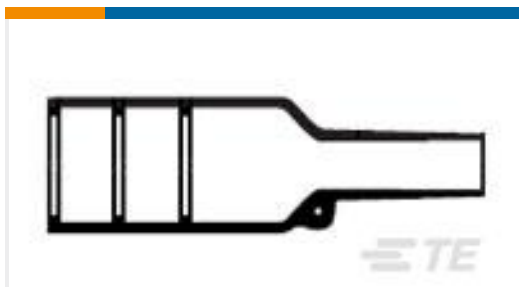

TE Part #878495-000
202K132-25-0



TE Part #52928
PIDG SPRSPD 22-16COM22-18MIL 5



TE Part #5-747908-2
15 Plug Solder Cup, Gold Flash



TE Part #2170707-3
CAGE ASSY, 1X6, QSFP28, SPRING, HS

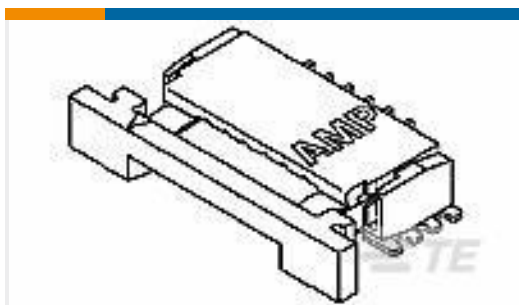

TE Part #2-84952-0
1MM FPC HORZ.BTTM CONT.ASS.20P



TE Part #170780-1
P.G RING UL.CSA(22-18)



TE Part #YDTS26F21-35ANV001
PLUG ASSY

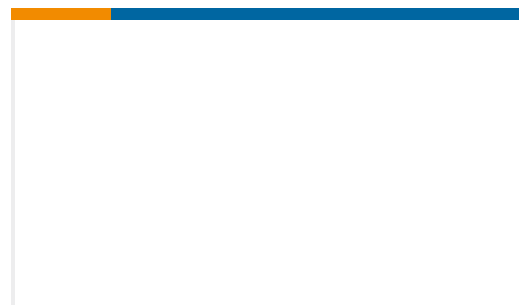

TE Part #1-2127931-4
C/A, SFP+, GENERIC, 3.0M

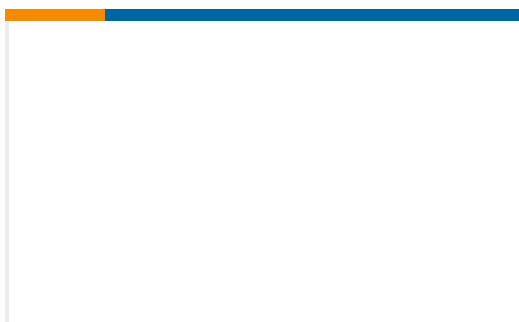

TE Part #1-2127934-8
C/A, SFP+, GENERIC, 7.0M

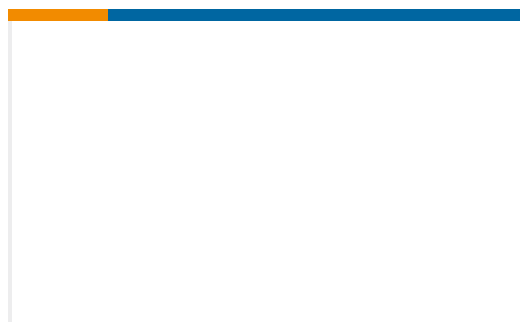

TE Part #1-2159124-2
C/A, SFP+, GENERIC, 1.0M



Documents

Product Drawings

[QSFP 25GIG 30AWG 1 METER](#)

English

CAD Files

[3D PDF](#)

3D

Customer View Model

[ENG_CVM_CVM_2333393-3_A.2d_dxf.zip](#)

English

Customer View Model

[ENG_CVM_CVM_2333393-3_A.3d_igs.zip](#)

English

Customer View Model

[ENG_CVM_CVM_2333393-3_A.3d_stp.zip](#)

English

By downloading the CAD file I accept and agree to the [Terms and Conditions](#) of use.

Product Specifications

[Product Specification](#)

English