

CD4503BC Hex Non-Inverting 3-STATE Buffer

General Description

The CD4503BC is a hex non-inverting 3-STATE buffer with high output current sink and source capability. 3-STATE outputs make it useful in bus-oriented applications. Two separate disable inputs are provided. Buffers 1 through 4 are controlled by the disable 4 input. Buffers 5 and 6 are controlled by the disable 2 input. A high level on either disable input will cause those gates on its control line to go into a high impedance state.

Features

- Wide supply voltage range: 3.0 V_{DC} to 18 V_{DC}
- 3-STATE outputs
- Symmetrical turn on/turn off delays
- Symmetrical output rise and fall times
- Pin-for-pin replacement for MM80C97 and MC14503

Ordering Code:

Order Number	Package Number	Package Description
CD4503BCM	M16A	16-Lead Small Outline Integrated Circuit (SOIC), JEDEC MS-012, 0.150" Narrow
CD4503BCN	N16E	16-Lead Plastic Dual-In-Line Package (PDIP), JEDEC MS-001, 0.300" Wide

Connection Diagram

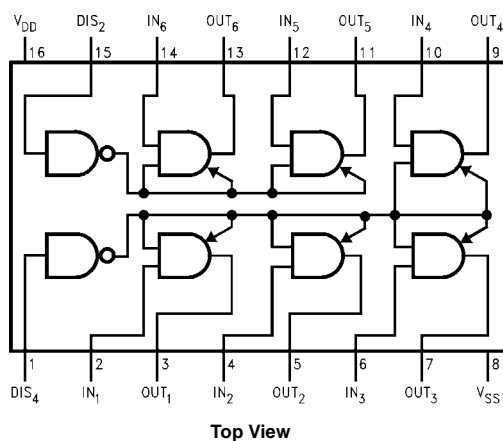

Schematic Diagram

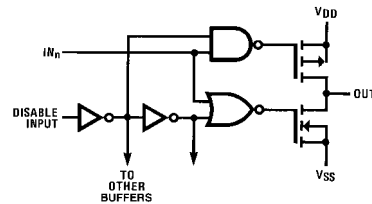

Truth Table

In	Disable Input	Out
0	0	0
1	0	1
X	1	3-STATE

X = Don't Care

Absolute Maximum Ratings (Note 1)

(Note 2)

Supply Voltage (V_{DD})	-0.5V to +18V
Input Voltage (V_{IN})	-0.5V to +0.5V
Storage Temperature Range (T_S)	-65°C to +150°C
Power Dissipation (P_D)	
Dual-In-Line	700 mW
Small Outline	500 mW
Lead Temperature (T_L)	
(Soldering, 10 seconds)	260°C

Recommended Operating Conditions (Note 2)

Supply Voltage (V_{DD})	+3V to +15V
Operating Temperature Range (T_A)	-55°C to +125°C

Note 1: "Absolute Maximum Ratings" are those values beyond which the safety of the device cannot be guaranteed. They are not meant to imply that the devices should be operated at these limits. The tables of "Recommended Operating Conditions" and "Electrical Characteristics" provide conditions for actual device operation.

Note 2: $V_{SS} = 0V$ unless otherwise specified.

DC Electrical Characteristics (Note 2)

Symbol	Parameter	Conditions	-55°C		+25°C			+125°C		Units
			Min	Max	Min	Typ	Max	Min	Max	
I_{DD}	Quiescent Device Current	$V_{DD} = 5V,$ $V_{IN} = V_{DD}$ or V_{SS}		1			1	30	μA	
		$V_{DD} = 10V,$ $V_{IN} = V_{DD}$ or V_{SS}		2		2	60			
		$V_{DD} = 15V,$ $V_{IN} = V_{DD}$ or V_{SS}		4		4	120			
		$V_{DD} = 15V,$ $V_{IN} = V_{DD}$ or V_{SS}								
V_{OL}	LOW Level Output Voltage	$V_{IN} = V_{DD}$ or 0							V	
		$V_{DD} = 5V$		0.05	0	0.05	0.05			
		$V_{DD} = 10V$ $V_{DD} = 15V$		0.05 0.05	0 0	0.05 0.05	0.05 0.05			
V_{OH}	HIGH Level Output Voltage	$V_{IN} = V_{DD}$ or 0							V	
		$V_{DD} = 5V$	4.95		4.95	5	4.95			
		$V_{DD} = 10V$ $V_{DD} = 15V$	9.95 14.95		9.95 14.95	10 15	9.95 14.95			
V_{IL}	LOW Level Input Voltage	$V_{DD} = 5V,$ $V_O = 4.5V$ or $0.5V$		1.5		2.25	1.5	1.5	V	
		$V_{DD} = 10V,$ $V_O = 9.0V$ or $1.0V$		3.0		4.50	3.0	3.0		
		$V_{DD} = 15V,$ $V_O = 13.5V$ or $1.5V$		4.0		6.75	4.0	4.0		
V_{IH}	HIGH Level Input Voltage	$V_{DD} = 5V,$ $V_O = 0.5V$ or $4.5V$	3.5		3.5	2.75		3.5	V	
		$V_{DD} = 10V,$ $V_O = 1.0V$ or $9.0V$	7.0		7.0	5.5		7.0		
		$V_{DD} = 15V,$ $V_O = 1.5V$ or $13.5V$	11.0		11.0	8.25		11.0		
I_{OL}	LOW Level Output Current	$V_{DD} = 4.5V, V_{OL} = 0.4V$	2.8		2.3	2.55		1.60	mA	
		$V_{DD} = 5.0V, V_{OL} = 0.4V$	3.0		2.4	2.75		1.75		
		$V_{DD} = 10V, V_{OL} = 0.5V$	7.85		6.35	7.00		4.45		
		$V_{DD} = 15V, V_{OL} = 1.5V$	19.95		16.10	25.00		11.30		
I_{OH}	HIGH Level Output Current	$V_{DD} = 5V, V_{OH} = 4.6V$	-1.28		-1.02	-1.76		-0.7	mA	
		$V_{DD} = 10V, V_{OH} = 9.5V$	-3.20		-2.60	-4.5		-1.8		
		$V_{DD} = 15V, V_{OH} = 13.5V$	-8.20		-6.80	-17.6		-4.8		
I_{OZ}	3-STATE Leakage Current	$V_{DD} = 15V$		± 0.1		$\pm 10^{-4}$	± 0.1		± 1.0	μA
I_{IN}	Input Current	$V_{DD} = 15V$		± 0.1		$\pm 10^{-4}$	± 0.1		± 1.0	μA

Note 3: I_{OH} and I_{OL} are tested one output at a time.

AC Electrical Characteristics (Note 4)

$T_A = 25^\circ\text{C}$, $C_L = 50\text{ pF}$, $R_L = 200\text{ k}\Omega$, Input $t_r = t_f = 20\text{ ns}$, unless otherwise specified

Symbol	Parameter	Conditions	Min	Typ	Max	Units
t_{PHL} , t_{PLH}	Propagation Delay Time	$V_{DD} = 5V$ $V_{DD} = 10V$ $V_{DD} = 15V$		75 35 25	100 40 30	ns
t_{PLZ} , t_{PHZ}	Propagation Delay Time, Logical Level to HIGH Impedance State	$V_{DD} = 5V$ $V_{DD} = 10V$ $V_{DD} = 15V$		80 40 35	125 90 70	ns
t_{PZL} , t_{PZH}	Propagation Delay Time, High Impedance State to Logical Level	$V_{DD} = 5V$ $V_{DD} = 10V$ $V_{DD} = 15V$		95 40 35	175 80 70	ns
t_{TLH}	Output Rise Time	$V_{DD} = 5V$ $V_{DD} = 10V$ $V_{DD} = 15V$		45 23 18	80 40 35	ns
t_{THL}	Output Fall Time	$V_{DD} = 5V$ $V_{DD} = 10V$ $V_{DD} = 15V$		45 23 18	80 40 35	ns

Note 4: AC Parameters are guaranteed by DC correlated testing.

AC Test Circuits and Switching Time Waveforms

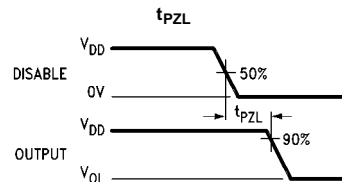
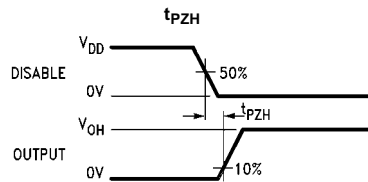
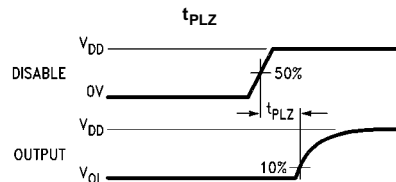
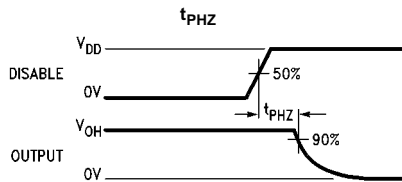
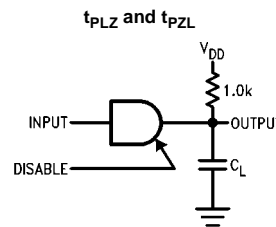
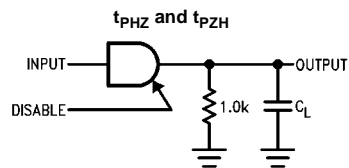
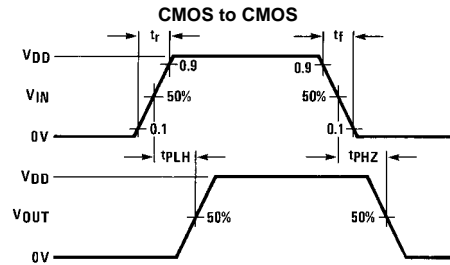
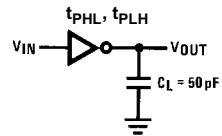

Note: Delays measured with input $t_r, t_f \leq 20$ ns.

Physical Dimensions inches (millimeters) unless otherwise noted

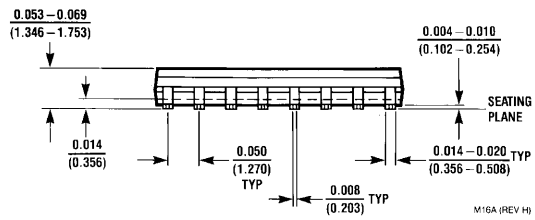
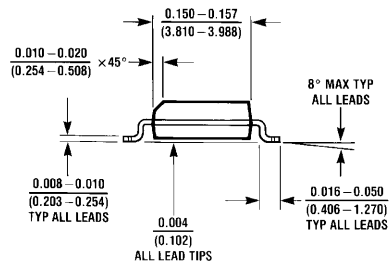
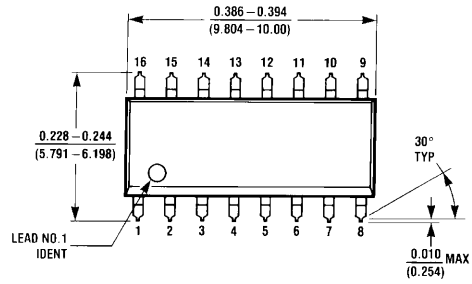

**16-Lead Small Outline Integrated Circuit (SOIC), JEDEC MS-012, 0.150" Narrow
Package Number M16A**

M16A (REV H)

Physical Dimensions inches (millimeters) unless otherwise noted (Continued)

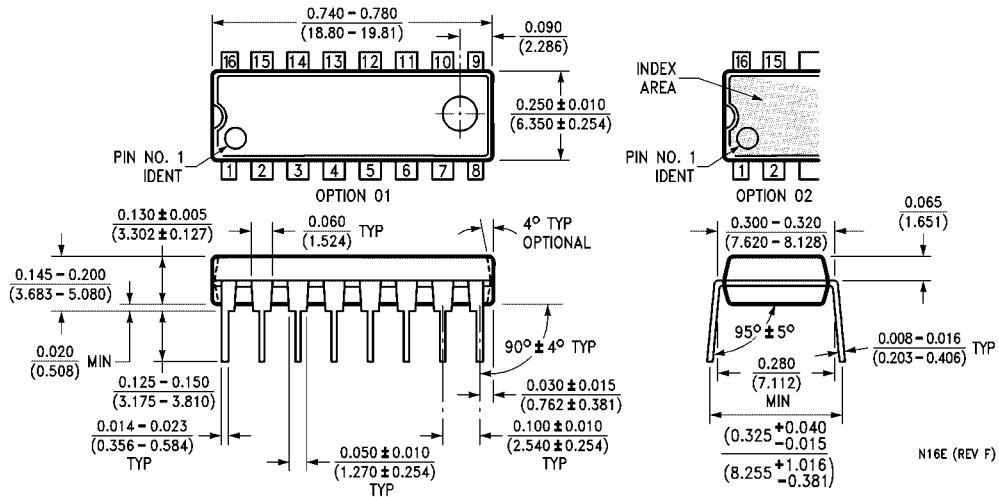

**16-Lead Plastic Dual-In-Line Package (PDIP), JEDEC MS-001, 0.300" Wide
Package Number N16E**

Fairchild does not assume any responsibility for use of any circuitry described, no circuit patent licenses are implied and Fairchild reserves the right at any time without notice to change said circuitry and specifications.

LIFE SUPPORT POLICY

FAIRCHILD'S PRODUCTS ARE NOT AUTHORIZED FOR USE AS CRITICAL COMPONENTS IN LIFE SUPPORT DEVICES OR SYSTEMS WITHOUT THE EXPRESS WRITTEN APPROVAL OF THE PRESIDENT OF FAIRCHILD SEMICONDUCTOR CORPORATION. As used herein:

1. Life support devices or systems are devices or systems which, (a) are intended for surgical implant into the body, or (b) support or sustain life, and (c) whose failure to perform when properly used in accordance with instructions for use provided in the labeling, can be reasonably expected to result in a significant injury to the user.
2. A critical component in any component of a life support device or system whose failure to perform can be reasonably expected to cause the failure of the life support device or system, or to affect its safety or effectiveness.

www.fairchildsemi.com