

SINGLE PORT VERTICAL MOUNT RJ45

ARV11-4292

- 10/100 BaseT for LAN and other Ethernet based applications
- Compliant to IEEE802.3
- Standard Operating Temp: 0°C to +70°C



Electrical Specifications @ 25°C

Part Number	OCL(uH Min) @ 100kHz, 0.1V With 8mA DC Bias	Turns Ratio chip: cable (± 3%)	Cross Talk (dB Min)			HI-POT 1500Vrms
			1-30MHz	30-60MHz	60-100MHz	
ARV11-4292	350	1CT:1CT	-40	-35	-30	

Electrical Specifications @ 25°C

Part Number	Insertion Loss (dB Max)	Return Loss (dB Min)			CMR (dB Min)	
		1-30MHz	30-60MHz	60-100MHz	1-50MHz	50-100MHz
ARV11-4292	-1.0	-18	-15	-12	-30	-20

All specifications subject to change without notice.

MECHANICAL

UNIT: mm

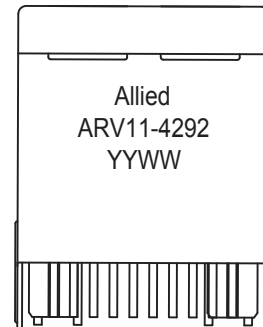
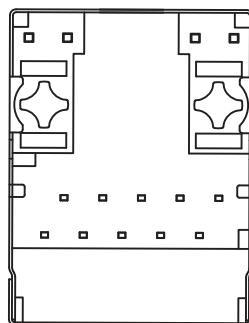
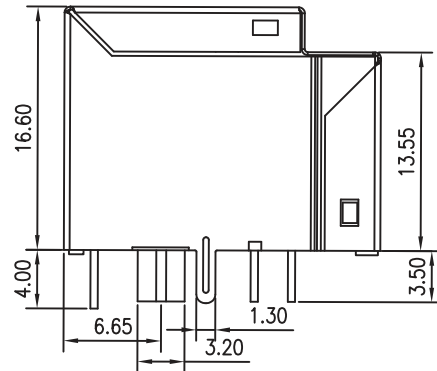
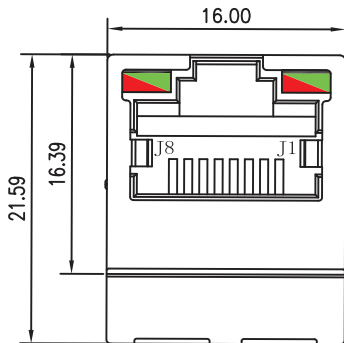

Unless otherwise specified, all tolerances are ±0.020mm



SCHEMATICS

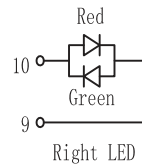
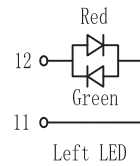
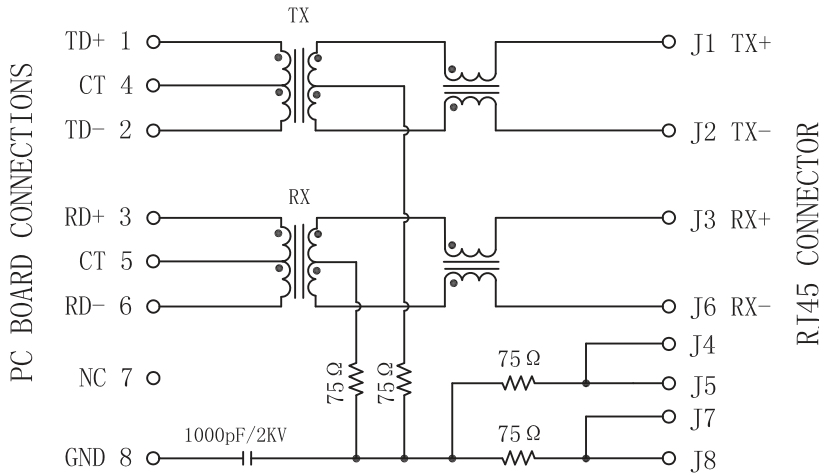

Emitting Color	λ p(nm)	VF@IF=20mA	IR @VR=5V
Green	570	1.8~2.4V	10 μ A max
Red	610	1.8~2.4V	10 μ A max

PCB LAYOUT

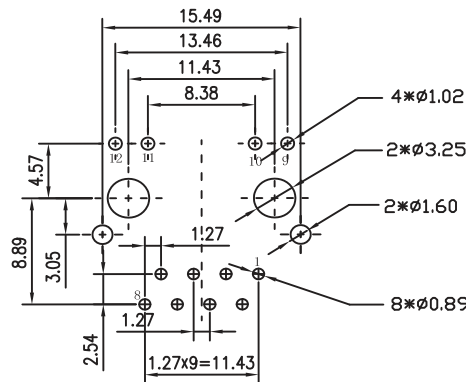

SUGGESTED PCB LAYOUT (TOP VIEW)

NOTES

1. Meets IEEE 802.3 specification
2. Connector Materials:
 Housing Material: Thermoplastic PBT+30%G.F UL94V-0
 Contact Material: Phosphor Bronze C5210R-EH Thickness=0.35mm
 Pins: Brass C2680R-H Thickness=0.35mm
 Shield: SUS 201-1/2H Thickness=0.2mm
 Contact plating: Gold 6 micro-inches min. In contact area.
3. Wave solder tip temperature: 265°C Max, 5 Sec Max