

TVS3300 33-V Flat-Clamp Surge Protection Device

1 Features

- Protection Against 1 kV, 42 Ω IEC 61000-4-5 Surge Test for Industrial Signal Lines
- Max Clamping Voltage of 40 V at 35 A of 8/20 μ s Surge Current
- Standoff Voltage: 33 V
- Tiny 1.1 mm² WCSP and 4 mm² SON Footprints
- Survives Over 4,000 Repetitive Strikes of 30 A 8/20 μ s Surge Current at 125°C
- Robust Surge Protection
 - IEC61000-4-5 (8/20 μ s): 35 A
 - IEC61643-321 (10/1000 μ s): 4 A
- Low Leakage Current
 - 19 nA Typical at 27°C
 - 28 nA Typical at 85°C
- Low Capacitance: 130 pF
- Integrated Level 4 IEC 61000-4-2 ESD Protection

2 Applications

- Industrial Sensors
- PLC I/O Modules
- 24 V Power Lines or Digital Switching Lines
- 4/20 mA Loops
- Appliances
- Medical Equipment
- Motor Drivers

3 Description

The TVS3300 robustly shunts up to 35 A of IEC 61000-4-5 fault current to protect systems from high power transients or lightning strikes. The device offers a solution to the common industrial signal line EMC requirement to survive up to 1 kV IEC 61000-4-5 open circuit voltage coupled through a 42 Ω impedance. The TVS3300 uses a unique feedback mechanism to ensure precise flat clamping during a fault, assuring system exposure below 40 V. The tight voltage regulation allows designers to confidently select system components with a lower voltage tolerance, lowering system costs and complexity without sacrificing robustness.

In addition, the TVS3300 is available in small 1 mm \times 1.1 mm WCSP and 2 mm \times 2 mm SON footprints which are ideal for space constrained applications, offering up to a 90 percent reduction in size compared to industry standard SMA and SMB packages. The extremely low device leakage and capacitance ensure a minimal effect on the protected line. To ensure robust protection over the lifetime of the product, TI tests the TVS3300 against 4000 repetitive surge strikes at high temperature with no shift in device performance.

The TVS3300 is part of TI's Flat-Clamp family of surge devices. For more information on the other devices in the family, see the [Device Comparison Table](#)

Device Information⁽¹⁾

PART NUMBER	PACKAGE	BODY SIZE (NOM)
TVS3300	WCSP (4)	1.062 mm \times 1.116 mm
	SON (6)	2.00 mm \times 2.00 mm

(1) For all available packages, see the orderable addendum at the end of the data sheet.

Footprint Comparison

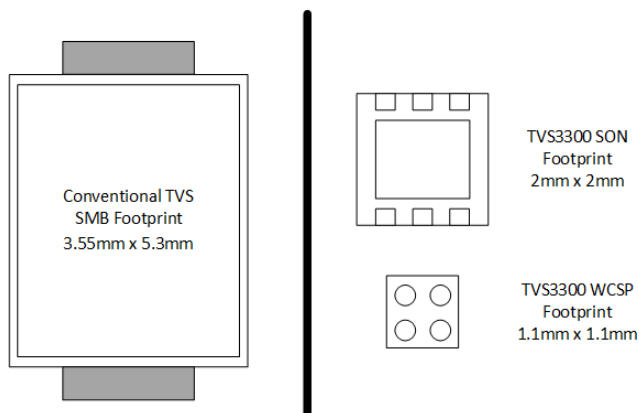

Voltage Clamp Response to 8/20 μ s Surge Event

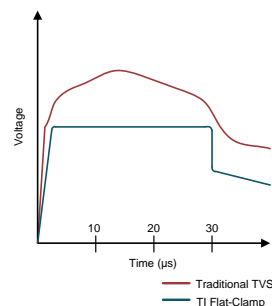

Table of Contents

1 Features	1	8.4 Reliability Testing	9
2 Applications	1	8.5 Device Functional Modes	9
3 Description	1	9 Application and Implementation	11
4 Revision History	2	9.1 Application Information	11
5 Device Comparison Table	3	9.2 Typical Application	11
6 Pin Configuration and Functions	4	10 Power Supply Recommendations	12
7 Specifications	5	11 Layout	13
7.1 Absolute Maximum Ratings	5	11.1 Layout Guidelines	13
7.2 ESD Ratings - JEDEC	5	11.2 Layout Example	13
7.3 ESD Ratings - IEC	5	12 Device and Documentation Support	15
7.4 Recommended Operating Conditions	5	12.1 Documentation Support	15
7.5 Thermal Information	5	12.2 Receiving Notification of Documentation Updates	15
7.6 Electrical Characteristics	6	12.3 Community Resources	15
7.7 Typical Characteristics	7	12.4 Trademarks	15
8 Detailed Description	9	12.5 Electrostatic Discharge Caution	15
8.1 Overview	9	12.6 Glossary	15
8.2 Functional Block Diagram	9	13 Mechanical, Packaging, and Orderable Information	15
8.3 Feature Description	9		

4 Revision History

Changes from Revision B (April 2017) to Revision C Page

- Data Sheet revised to match other TVSxx00 family devices 1

Changes from Revision A (March 2017) to Revision B Page

- Updated standard for (10/1000 μ s) from IEC 61000-4-5 to IEC 61643-321 in the *Absolute Maximum Ratings* table 5

Changes from Original (Feb 2017) to Revision A Page

- Added SON package option 1
- Added ± 11 -kV Contact Discharge (SON) to the *Features* section 1
- Added Peak pulse—clamping direction specs for SON package in the *Absolute Maximum Ratings* table 5
- Added IEC 61000-4-2 contact discharge spec for SON package in the *ESD Ratings - IEC* table 5
- Added $T_A = 27^\circ\text{C}$ condition to dynamic resistance in the *Electrical Characteristics* table 5

5 Device Comparison Table

Device	V_{rwm}	V_{clamp} at I_{pp}	I_{pp} (8/20 μ s)	V_{rwm} leakage (nA)	Package Options	Polarity
TVS0500	5	9.2	43	0.07	SON	Unidirectional
TVS1400	14	18.4	43	2	SON	Unidirectional
TVS1800	18	22.8	40	0.5	SON	Unidirectional
TVS2200	22	27.7	40	3.2	SON	Unidirectional
TVS2700	27	32.5	40	1.7	SON	Unidirectional
TVS3300	33	38	35	19	WCSP, SON	Unidirectional

6 Pin Configuration and Functions

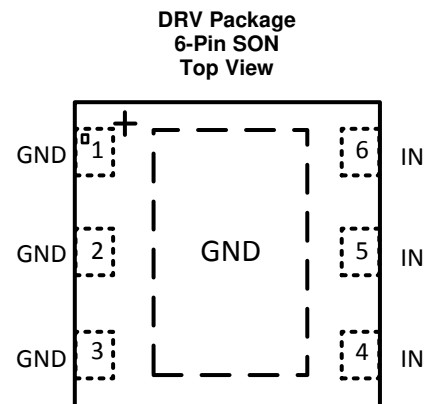
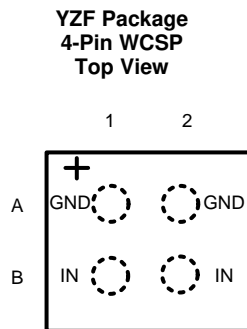

Pin Functions

PIN			TYPE	DESCRIPTION
NAME	YZF	DRV		
IN	B1, B2	4, 5, 6	I	ESD and surge protected channel
GND	A1, A2	1, 2, 3, exposed thermal pad	GND	Ground

7 Specifications

7.1 Absolute Maximum Ratings

 $T_A = 27^\circ\text{C}$ (unless otherwise noted)⁽¹⁾

		MIN	MAX	UNIT
Maximum Surge	IEC 61000-4-5 Current (8/20 μs)		35	A
	IEC 61000-4-5 Power (8/20 μs)		1330	W
	IEC 61643-321 Current (10/1000 μs) - WCSP		4	A
	IEC 61643-321 Power (10/1000 μs) - WCSP		150	W
	IEC 61643-321 Current (10/1000 μs) - DRV		3.5	A
	IEC 61643-321 Power (10/1000 μs) - DRV		125	W
Maximum Forward Surge	IEC 61000-4-5 Current (8/20 μs)		50	A
	IEC 61000-4-5 Power (8/20 μs)		80	W
	IEC 61643-321 Current (10/1000 μs)		23	A
	IEC 61643-321 Power (10/1000 μs)		60	W
EFT	IEC 61000-4-4 EFT Protection		80	A
I_{BR}	DC Breakdown Current - DRV		10	mA
I_F	DC Forward Current		500	mA
T_A	Ambient Operating Temperature	-40	125	$^\circ\text{C}$
T_{stg}	Storage Temperature	-65	150	$^\circ\text{C}$

(1) Stresses beyond those listed under *Absolute Maximum Rating* may cause permanent damage to the device. These are stress ratings only, which do not imply functional operation of the device at these or any other conditions beyond those indicated under *Recommended Operating Condition*. Exposure to absolute-maximum-rated conditions for extended periods may affect device reliability.

7.2 ESD Ratings - JEDEC

		VALUE	UNIT
$V_{(ESD)}$	Electrostatic discharge	Human body model (HBM), per ANSI/ESDA/JEDEC JS-001, all pins ⁽¹⁾	± 2000
		Charged device model (CDM), per JEDEC specification JESD22-C101, all pins ⁽²⁾	± 500

(1) JEDEC document JEP155 states that 500-V HBM allows safe manufacturing with a standard ESD control process.

(2) JEDEC document JEP157 states that 250-V CDM allows safe manufacturing with a standard ESD control process.

7.3 ESD Ratings - IEC

		VALUE	UNIT
$V_{(ESD)}$	Electrostatic discharge	IEC 61000-4-2 contact discharge	± 11
		IEC 61000-4-2 air-gap discharge	± 30

7.4 Recommended Operating Conditions

over operating free-air temperature range (unless otherwise noted)

PARAMETER		MIN	NOM	MAX	UNIT
V_{RWM}	Reverse Stand-off Voltage		33		V

7.5 Thermal Information

THERMAL METRIC ⁽¹⁾		TVS3300		UNIT
		YZF (WCSP)	DRV (SON)	
		4 PINS	6 PINS	
R_{qJA}	Junction-to-ambient thermal resistance	173.8	70.4	$^\circ\text{C}/\text{W}$
$R_{qJC(top)}$	Junction-to-case (top) thermal resistance	1.7	73.7	$^\circ\text{C}/\text{W}$

(1) For more information about traditional and new thermal metrics, see the [Semiconductor and IC Package Thermal Metrics](#) application report.

Thermal Information (continued)

THERMAL METRIC ⁽¹⁾	TVS3300		UNIT	
	YZF (WCSP)	DRV (SON)		
	4 PINS	6 PINS		
R _{qJB}	Junction-to-board thermal resistance	47.1	40	°C/W
Y _{JT}	Junction-to-top characterization parameter	9.5	2.2	°C/W
Y _{JB}	Junction-to-board characterization parameter	47.1	40.3	°C/W
R _{qJC(bot)}	Junction-to-case (bottom) thermal resistance	N/A	11	°C/W

7.6 Electrical Characteristics

over operating free-air temperature range (unless otherwise noted)

PARAMETER	TEST CONDITIONS	MIN	TYP	MAX	UNIT			
I _{LEAK}	Leakage Current	Measured at V _{IN} = V _{RWM} , T _A = 27°C			19	150	nA	
		Measured at V _{IN} = V _{RWM} , T _A = 85°C			28	600	nA	
V _F	Forward Voltage	I _{IN} = 1 mA from GND to IO			0.25	0.5	0.65	V
V _{BR}	Break-down Voltage	I _{IN} = 1 mA from IO to GND			34	35.8	39	V
V _{FCLAMP}	Forward Clamp Voltage	35 A IEC 61000-4-5 Surge (8/20 μs) from GND to IO, 27°C			1	2	5	V
V _{CLAMP}	Clamp Voltage	15 A IEC 61000-4-5 Surge (8/20 μs) from IO to GND, V _{IN} = 0 V before surge, 27°C			34	37	40	V
		35 A IEC 61000-4-5 Surge (8/20 μs) from IO to GND, V _{IN} = 0 V before surge, 27°C			34	38	40	V
R _{DYN}	8/20 μs surge dynamic resistance	Calculated from V _{CLAMP} at 15 A and 30 A surge current levels, 27°C				40	60	mΩ
C _{IN}	Input pin capacitance	V _{IN} = 12 V, f = 1 MHz, 30 mV _{pp} , IO to GND			110	130	150	pF
SR	Maximum Slew Rate	0-V _{RWM} rising edge, sweep rise time and measure slew rate when I _{PEAK} = 1 mA, 27°C				2.5		V/μs
		0-V _{RWM} rising edge, sweep rise time and measure slew rate when I _{PEAK} = 1 mA, 105°C				0.7		V/μs

7.7 Typical Characteristics

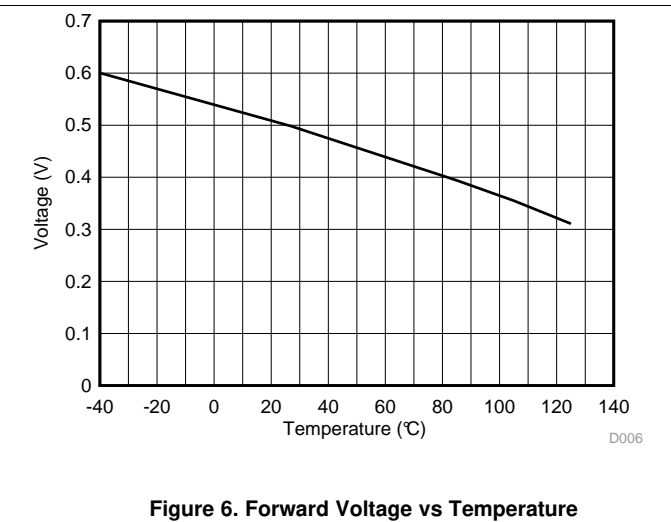
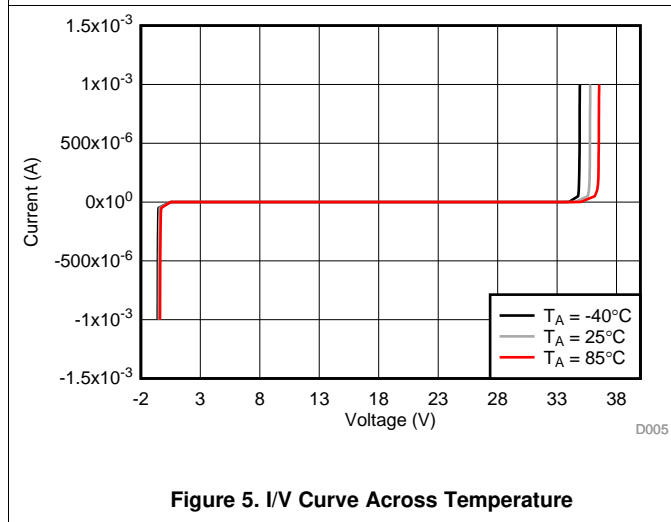
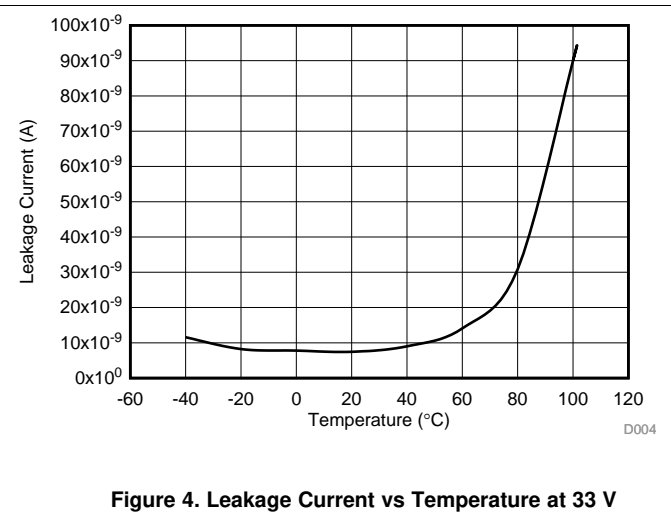
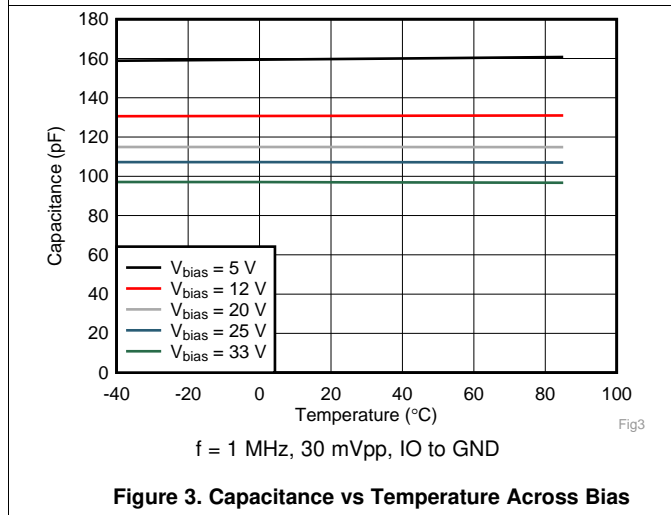
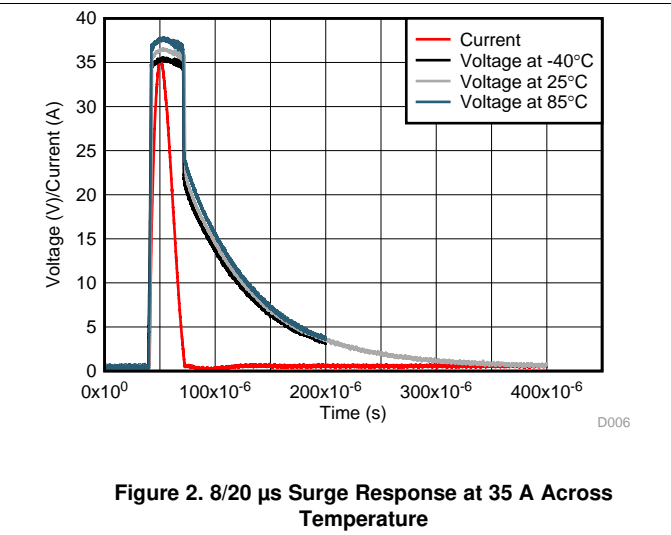
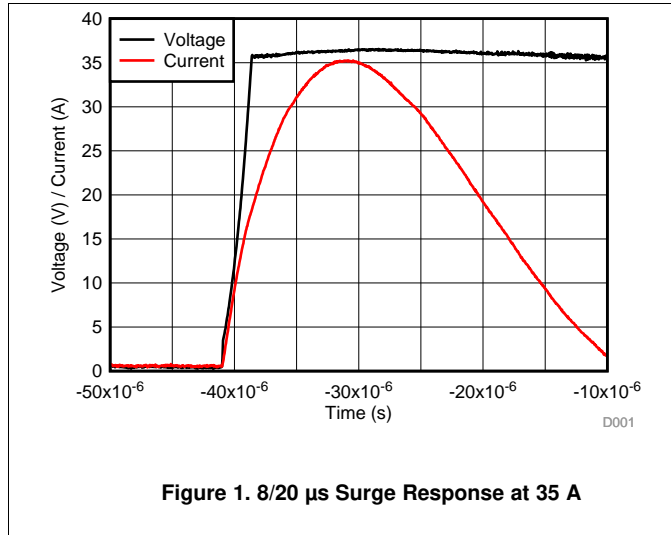

Typical Characteristics (continued)

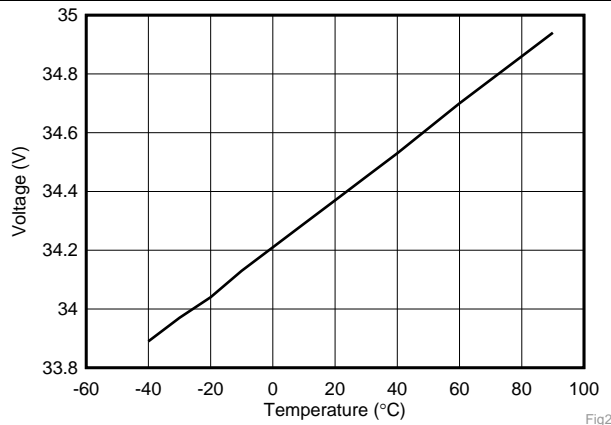

Figure 7. Breakdown Voltage (1 mA) vs Temperature

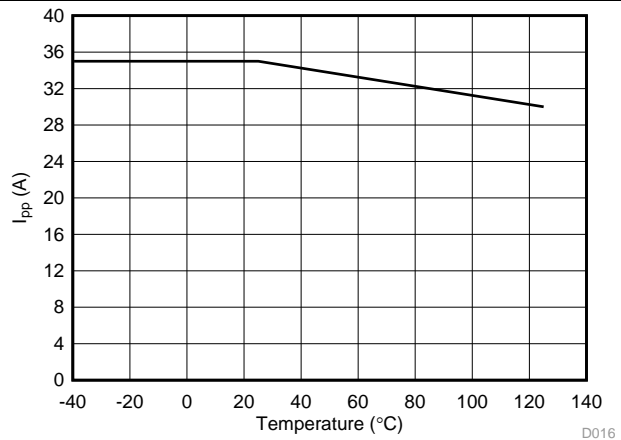

Figure 8. Max Surge Current (8/20 μs) vs Temperature

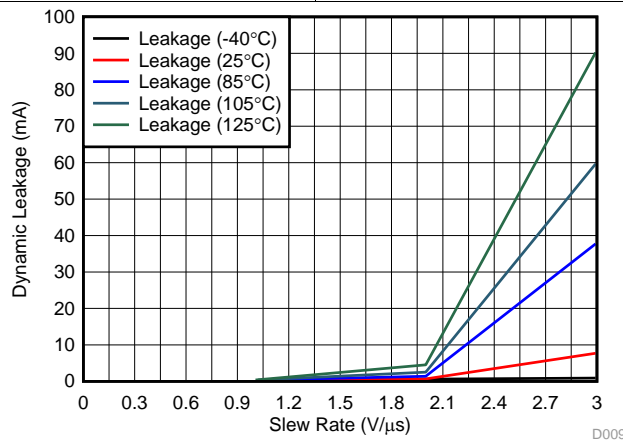

Figure 9. Dynamic Leakage vs Signal Slew Rate across Temperature

8 Detailed Description

8.1 Overview

The TVS3300 is a precision clamp with a low, flat clamping voltage during transient overvoltage events like surge and protecting the system with zero voltage overshoot.

8.2 Functional Block Diagram

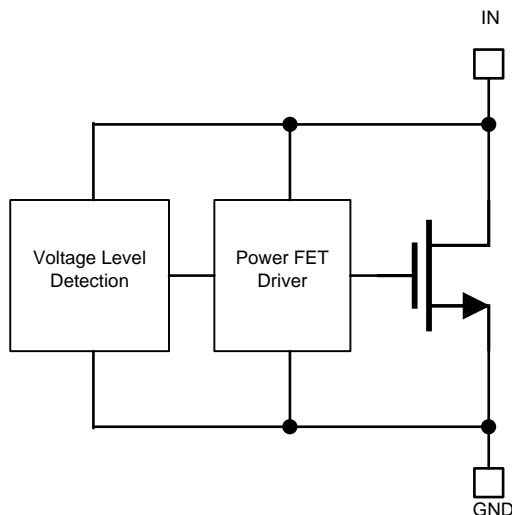

Copyright © 2017, Texas Instruments Incorporated

8.3 Feature Description

The TVS3300 is a precision clamp that handles 35 A of IEC 61000-4-5 8/20 μ s surge pulse. The flat clamping feature helps keep the clamping voltage very low to keep the downstream circuits from being stressed. The flat clamping feature can also help end-equipment designers save cost by opening up the possibility to use lower-cost, lower voltage tolerant downstream ICs. The TVS3300 has minimal leakage under the standoff voltage of 33 V, making it an ideal candidate for applications where low leakage and power dissipation is a necessity. IEC 61000-4-2 and IEC 61000-4-4 ratings make it a robust protection solution for ESD and EFT events. Wide ambient temperature range of -40°C to $+125^{\circ}\text{C}$ a good candidate for most applications. Compact packages enable it to be used in small devices and save board area.

8.4 Reliability Testing

To ensure device reliability, the TVS3300 is characterized against 4000 repetitive pulses of 30 A IEC 61000-4-5 8/20 μ s surge pulses at 125°C . The test is performed with less than 10 seconds between each pulse at high temperature to simulate worst case scenarios for fault regulation. After each surge pulse, the TVS3300 clamping voltage, breakdown voltage, and leakage are recorded to ensure that there is no variation or performance degradation. By ensuring robust, reliable, high temperature protection, the TVS3300 enables fault protection in applications that must withstand years of continuous operation with no performance change.

8.5 Device Functional Modes

8.5.1 Protection Specifications

The TVS3300 is specified according to both the IEC 61000-4-5 and IEC 61643-321 standards. This enables usage in systems regardless of which standard is required in relevant product standards or best matches measured fault conditions. The IEC 61000-4-5 standards requires protection against a pulse with a rise time of 8 μ s and a half length of 20 μ s, while the IEC 61643-321 standard requires protection against a much longer pulse with a rise time of 10 μ s and a half length of 1000 μ s.

Device Functional Modes (continued)

The positive and negative surges are imposed to the TVS3300 by a combinational waveform generator (CWG) with a 2- Ω coupling resistor at different peak voltage levels. For powered on transient tests that need power supply bias, inductances are usually used to decouple the transient stress and protect the power supply. The TVS3300 is post tested by assuring that there is no shift in device breakdown or leakage at V_{rwm} .

In addition, the TVS3300 has been tested according to IEC 61000-4-5 to pass a ± 1 kV surge test through a 42- Ω coupling resistor and a 0.5 μF capacitor. This test is a common test requirement for industrial signal I/O lines and the TVS3300 will serve an ideal protection solution for applications with that requirement.

The TVS3300 allow integrates IEC 61000-4-2 level 4 ESD Protection and 80 A of IEC 61000-4-4 EFT Protection. These combine to ensure that the device can protect against most transient conditions regardless of length or type.

For more information on TI's test methods for Surge, ESD, and EFT testing, reference [TI's IEC 61000-4-x Testing Application Note](#)

8.5.2 Minimal Derating

Unlike traditional diodes the TVS3300 has very little derating of max power dissipation and ensures robust performance up to 125°C, shown in [Figure 8](#). Traditional TVS diodes lose up to 50% of their current carrying capability when at high temperatures, so a surge pulse above 85°C ambient can cause failures that are not seen at room temperature. The TVS3300 prevents this and ensures that you will see the same level of protection regardless of temperature.

8.5.3 Transient Performance

During large transient swings, the TVS3300 will begin clamping the input signal to protect downstream conditions. While this prevents damage during fault conditions, it can cause leakage when the intended input signal has a fast slew rate. In order to keep power dissipation low and remove the chance of signal distortion, it is recommended to keep the slew rate of any input signal on the TVS3300 below 2.5 V/ μs at room temperature and below 0.7 V/ μs at 125°C shown in [Figure 9](#). Faster slew rates will cause the device to clamp the input signal and draw current through the device for a few microseconds, increasing the rise time of the signal. This will not cause any harm to the system or to the device, however if the fast input voltage swings occur regularly it can cause device overheating.

Typical Application (continued)

The small size of the device also improves fault protection by lowering the effect of fault current coupling onto neighboring traces. The small form factor of the TVS3300 allows the device to be placed extremely close to the input connector, lowering the length of the path fault current will take through the system compared to larger protection solutions.

Finally, the low leakage of the TVS3300 will have low input power losses. At 33 V, the device will see typical 19 nA leakage for a constant power dissipation of less than 100 μ W, a small quantity that will minimally effect overall efficiency metrics and heating concerns.

9.2.3 PLC Surge Protection Reference Design

For a detailed description of the TVS3300 advantages in a PLC Analog Input Module, reference TI's [Surge Protection Reference Design for PLC Analog Input Module](#) This document describes the considerations and performance of the TVS3300 in a common industrial application.

9.2.4 Configuration Options

The TVS3300 can be used in either unidirectional or bidirectional configuration. By placing two TVS3300's in series with reverse orientation bidirectional operation can be used, allowing a working voltage of ± 33 V. TVS3300 operation in bidirectional will be similar to unidirectional operation, with a minor increase in breakdown voltage and clamping voltage. The TVS3300 bidirectional performance has been characterized in the [TVS3300 Configurations Characterization](#).

10 Power Supply Recommendations

The TVS3300 is a clamping device so there is no need to power it. To ensure the device functions properly do not violate the recommended V_{IN} voltage range (0 V to 33 V) .

11 Layout

11.1 Layout Guidelines

The optimum placement is close to the connector. EMI during an ESD event can couple from the trace being struck to other nearby unprotected traces, resulting in early system failures. The PCB designer must minimize the possibility of EMI coupling by keeping any unprotected traces away from the protected traces which are between the TVS and the connector.

Route the protected traces straight.

Eliminate any sharp corners on the protected traces between the TVS3300 and the connector by using rounded corners with the largest radii possible. Electric fields tend to build up on corners, increasing EMI coupling.

11.2 Layout Example

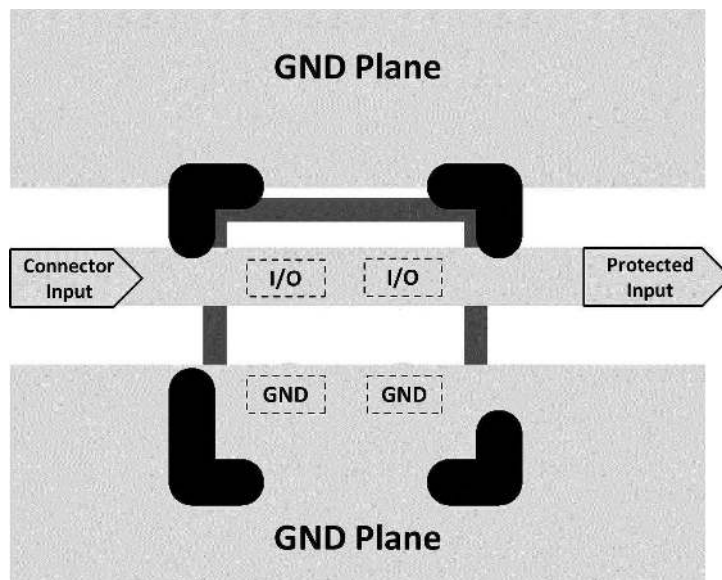

Figure 11. TVS3300 WCSP Layout

Layout Example (continued)

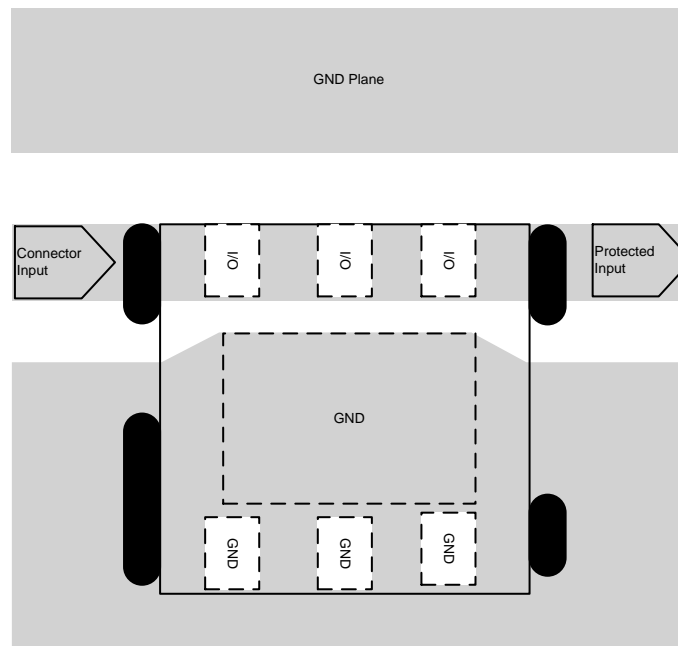

Figure 12. TVS3300 SON Layout

12 Device and Documentation Support

12.1 Documentation Support

12.1.1 Related Documentation

For related documentation see the following:

- [Flat-Clamp TVS Evaluation Kit](#)
- Surge Protection Reference Design for PLC Analog Input Module
- [TVS3300 Evaluation Module User's Guide](#)
- [TVS3300DRV Evaluation Module User's Guide](#)

12.2 Receiving Notification of Documentation Updates

To receive notification of documentation updates, navigate to the device product folder on ti.com. In the upper right corner, click on *Alert me* to register and receive a weekly digest of any product information that has changed. For change details, review the revision history included in any revised document.

12.3 Community Resources

The following links connect to TI community resources. Linked contents are provided "AS IS" by the respective contributors. They do not constitute TI specifications and do not necessarily reflect TI's views; see TI's [Terms of Use](#).

TI E2E™ Online Community *TI's Engineer-to-Engineer (E2E) Community*. Created to foster collaboration among engineers. At e2e.ti.com, you can ask questions, share knowledge, explore ideas and help solve problems with fellow engineers.

Design Support *TI's Design Support* Quickly find helpful E2E forums along with design support tools and contact information for technical support.

12.4 Trademarks

E2E is a trademark of Texas Instruments.

12.5 Electrostatic Discharge Caution



This integrated circuit can be damaged by ESD. Texas Instruments recommends that all integrated circuits be handled with appropriate precautions. Failure to observe proper handling and installation procedures can cause damage.

ESD damage can range from subtle performance degradation to complete device failure. Precision integrated circuits may be more susceptible to damage because very small parametric changes could cause the device not to meet its published specifications.

12.6 Glossary

[SLYZ022](#) — *TI Glossary*.

This glossary lists and explains terms, acronyms, and definitions.

13 Mechanical, Packaging, and Orderable Information

The following pages include mechanical, packaging, and orderable information. This information is the most current data available for the designated devices. This data is subject to change without notice and revision of this document. For browser-based versions of this data sheet, refer to the left-hand navigation.

PACKAGING INFORMATION

Orderable Device	Status (1)	Package Type	Package Drawing	Pins	Package Qty	Eco Plan (2)	Lead finish/ Ball material (6)	MSL Peak Temp (3)	Op Temp (°C)	Device Marking (4/5)	Samples
TVS3300DRVR	ACTIVE	WSON	DRV	6	3000	RoHS & Green	NIPDAU	Level-1-260C-UNLIM	-40 to 125	17JH	Samples
TVS3300YZFR	ACTIVE	DSBGA	YZF	4	3000	RoHS & Green	SNAGCU	Level-1-260C-UNLIM	-40 to 125	15K	Samples

(1) The marketing status values are defined as follows:

ACTIVE: Product device recommended for new designs.

LIFEBUY: TI has announced that the device will be discontinued, and a lifetime-buy period is in effect.

NRND: Not recommended for new designs. Device is in production to support existing customers, but TI does not recommend using this part in a new design.

PREVIEW: Device has been announced but is not in production. Samples may or may not be available.

OBSOLETE: TI has discontinued the production of the device.

(2) **RoHS:** TI defines "RoHS" to mean semiconductor products that are compliant with the current EU RoHS requirements for all 10 RoHS substances, including the requirement that RoHS substance do not exceed 0.1% by weight in homogeneous materials. Where designed to be soldered at high temperatures, "RoHS" products are suitable for use in specified lead-free processes. TI may reference these types of products as "Pb-Free".

RoHS Exempt: TI defines "RoHS Exempt" to mean products that contain lead but are compliant with EU RoHS pursuant to a specific EU RoHS exemption.

Green: TI defines "Green" to mean the content of Chlorine (Cl) and Bromine (Br) based flame retardants meet JS709B low halogen requirements of <=1000ppm threshold. Antimony trioxide based flame retardants must also meet the <=1000ppm threshold requirement.

(3) MSL, Peak Temp. - The Moisture Sensitivity Level rating according to the JEDEC industry standard classifications, and peak solder temperature.

(4) There may be additional marking, which relates to the logo, the lot trace code information, or the environmental category on the device.

(5) Multiple Device Markings will be inside parentheses. Only one Device Marking contained in parentheses and separated by a "~" will appear on a device. If a line is indented then it is a continuation of the previous line and the two combined represent the entire Device Marking for that device.

(6) Lead finish/Ball material - Orderable Devices may have multiple material finish options. Finish options are separated by a vertical ruled line. Lead finish/Ball material values may wrap to two lines if the finish value exceeds the maximum column width.

Important Information and Disclaimer:The information provided on this page represents TI's knowledge and belief as of the date that it is provided. TI bases its knowledge and belief on information provided by third parties, and makes no representation or warranty as to the accuracy of such information. Efforts are underway to better integrate information from third parties. TI has taken and continues to take reasonable steps to provide representative and accurate information but may not have conducted destructive testing or chemical analysis on incoming materials and chemicals. TI and TI suppliers consider certain information to be proprietary, and thus CAS numbers and other limited information may not be available for release.

In no event shall TI's liability arising out of such information exceed the total purchase price of the TI part(s) at issue in this document sold by TI to Customer on an annual basis.

TAPE AND REEL INFORMATION

QUADRANT ASSIGNMENTS FOR PIN 1 ORIENTATION IN TAPE

*All dimensions are nominal

Device	Package Type	Package Drawing	Pins	SPQ	Reel Diameter (mm)	Reel Width W1 (mm)	A0 (mm)	B0 (mm)	K0 (mm)	P1 (mm)	W (mm)	Pin1 Quadrant
TVS3300DRVR	WSO	DRV	6	3000	180.0	8.4	2.3	2.3	1.15	4.0	8.0	Q2
TVS3300YZFR	DSBGA	YZF	4	3000	180.0	8.4	1.17	1.22	0.72	2.0	8.0	Q1

TAPE AND REEL BOX DIMENSIONS

*All dimensions are nominal

Device	Package Type	Package Drawing	Pins	SPQ	Length (mm)	Width (mm)	Height (mm)
TVS3300DRVR	WSON	DRV	6	3000	210.0	185.0	35.0
TVS3300YZFR	DSBGA	YZF	4	3000	182.0	182.0	20.0

GENERIC PACKAGE VIEW

DRV 6

WSON - 0.8 mm max height

PLASTIC SMALL OUTLINE - NO LEAD

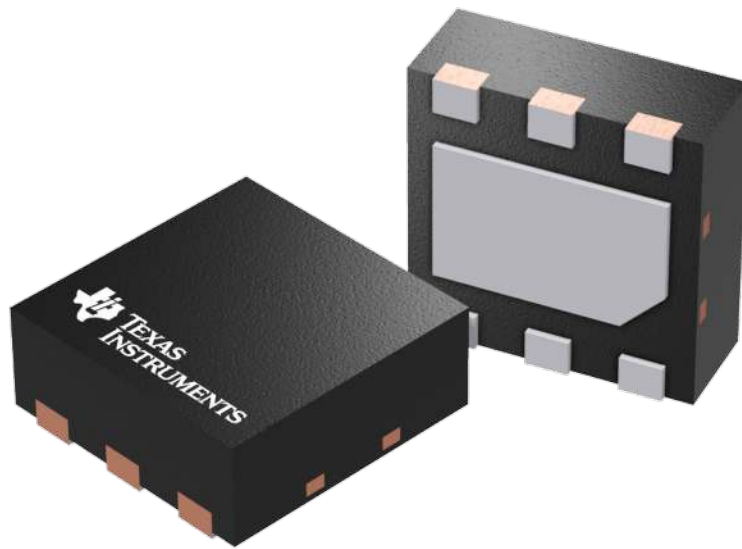

Images above are just a representation of the package family, actual package may vary.
Refer to the product data sheet for package details.

4206925/F

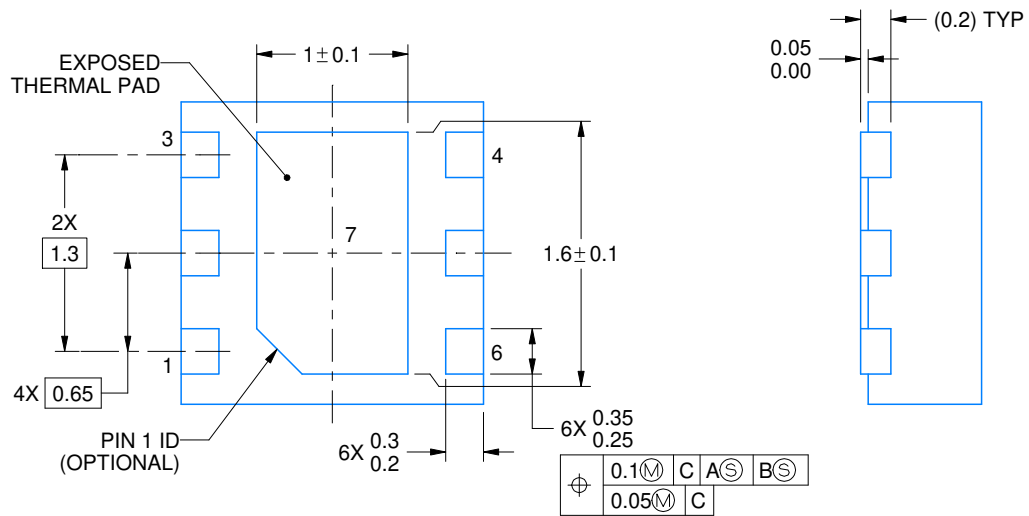
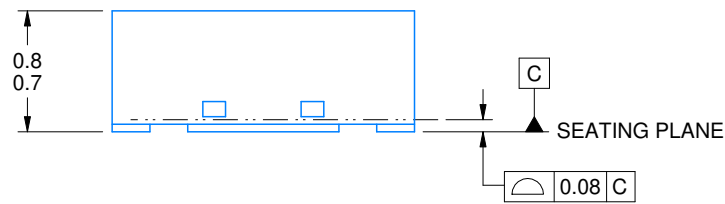
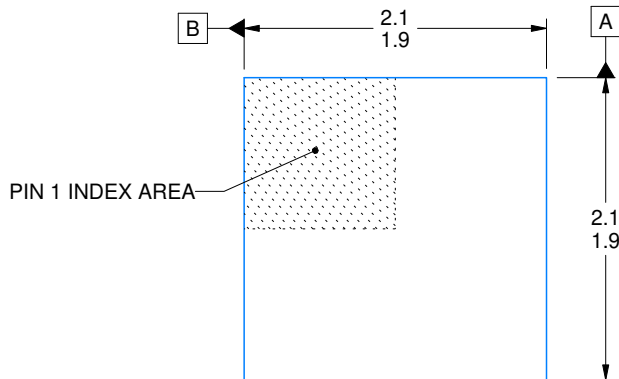

4222173/B 04/2018

NOTES:

1. All linear dimensions are in millimeters. Any dimensions in parenthesis are for reference only. Dimensioning and tolerancing per ASME Y14.5M.
2. This drawing is subject to change without notice.
3. The package thermal pad must be soldered to the printed circuit board for thermal and mechanical performance.

EXAMPLE BOARD LAYOUT

DRV0006A

WSON - 0.8 mm max height

PLASTIC SMALL OUTLINE - NO LEAD

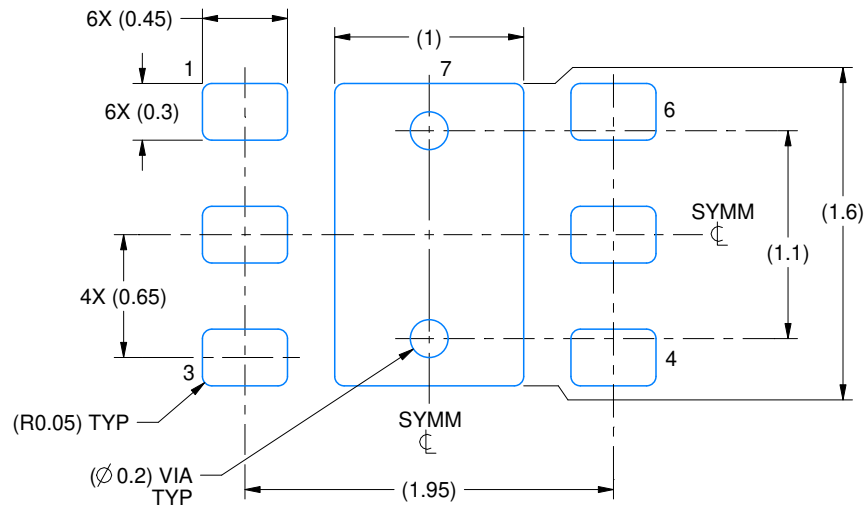

LAND PATTERN EXAMPLE
SCALE:25X

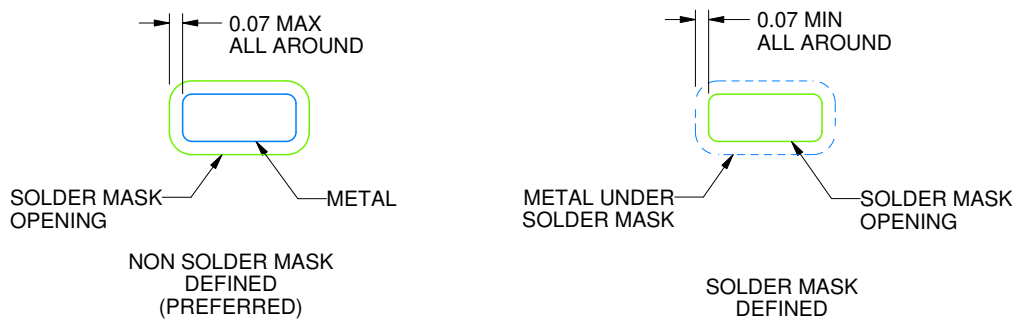

SOLDER MASK DETAILS

4222173/B 04/2018

NOTES: (continued)

4. This package is designed to be soldered to a thermal pad on the board. For more information, see Texas Instruments literature number SLUA271 (www.ti.com/lit/sluea271).
5. Vias are optional depending on application, refer to device data sheet. If some or all are implemented, recommended via locations are shown.

EXAMPLE STENCIL DESIGN

DRV0006A

WSON - 0.8 mm max height

PLASTIC SMALL OUTLINE - NO LEAD

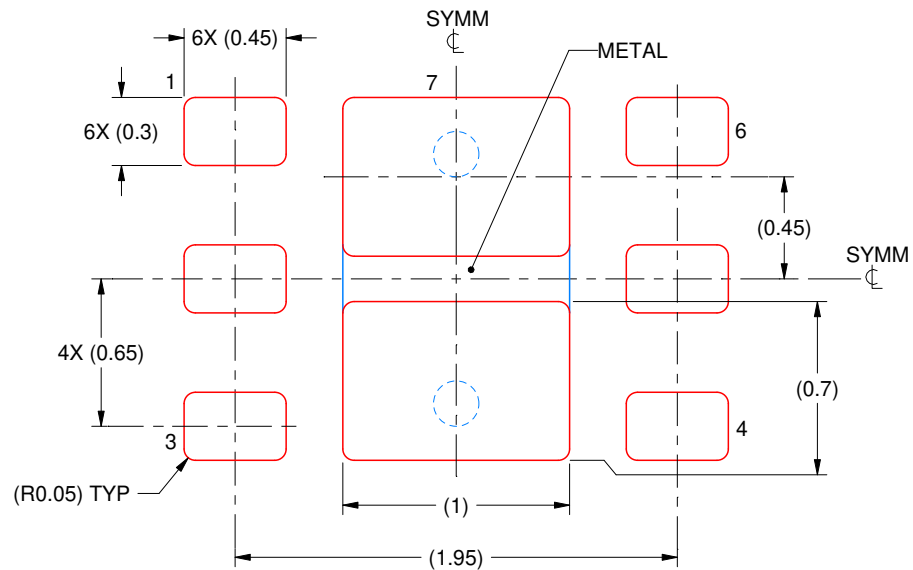

SOLDER PASTE EXAMPLE
BASED ON 0.125 mm THICK STENCIL

EXPOSED PAD #7
88% PRINTED SOLDER COVERAGE BY AREA UNDER PACKAGE
SCALE:30X

4222173/B 04/2018

NOTES: (continued)

6. Laser cutting apertures with trapezoidal walls and rounded corners may offer better paste release. IPC-7525 may have alternate design recommendations.

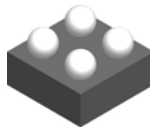

YZF0004

PACKAGE OUTLINE

DSBGA - 0.625 mm max height

DIE SIZE BALL GRID ARRAY

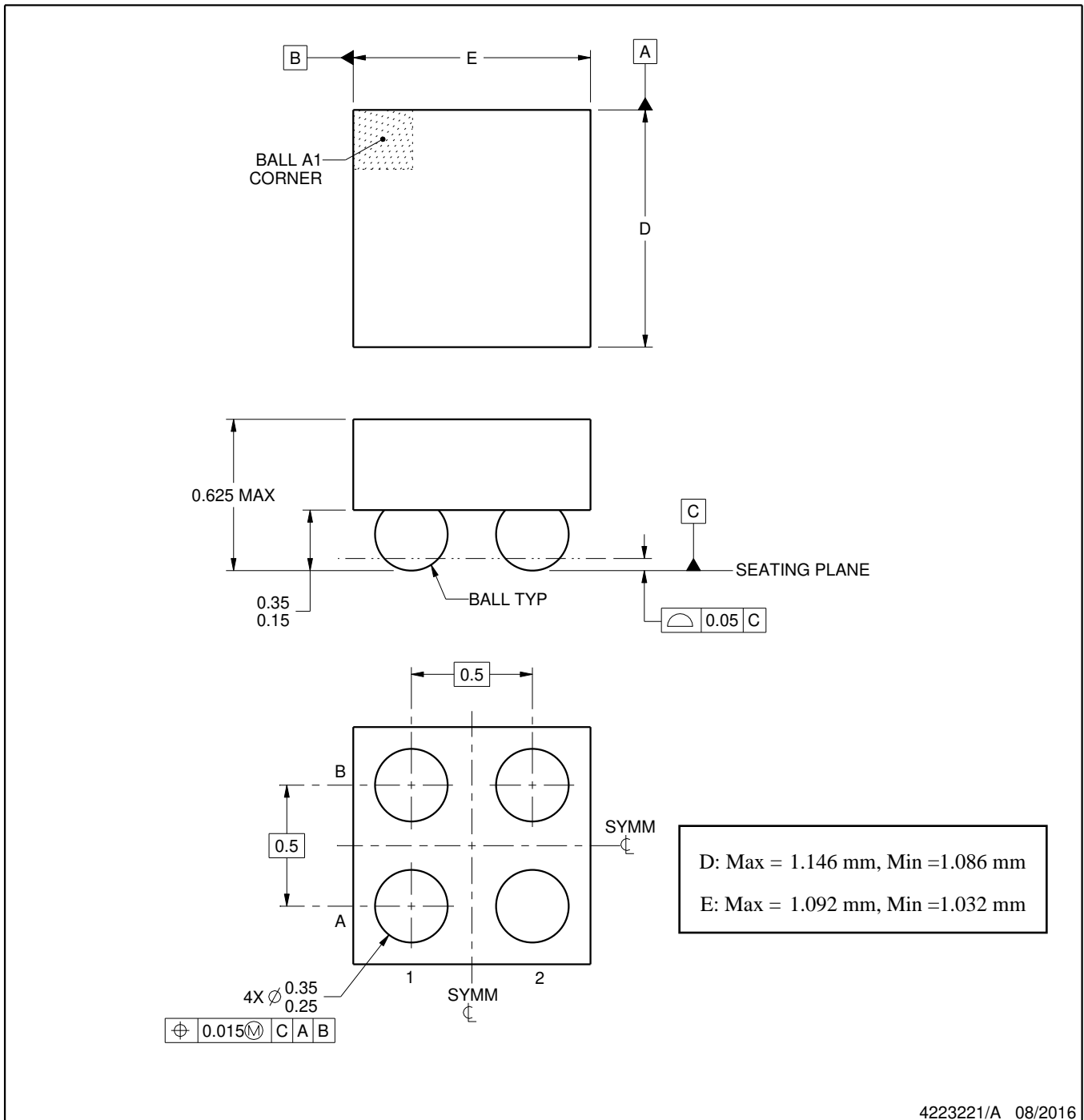

NOTES:

1. All linear dimensions are in millimeters. Any dimensions in parenthesis are for reference only. Dimensioning and tolerancing per ASME Y14.5M.
2. This drawing is subject to change without notice.

EXAMPLE BOARD LAYOUT

YZF0004

DSBGA - 0.625 mm max height

DIE SIZE BALL GRID ARRAY

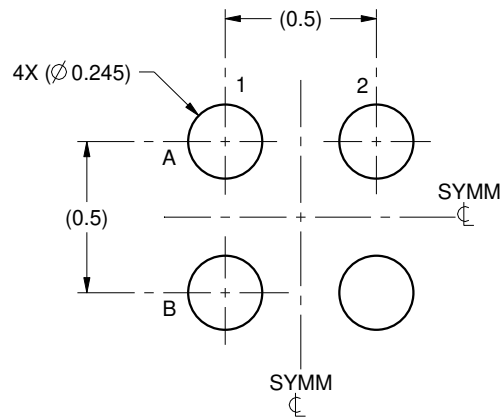

LAND PATTERN EXAMPLE
SCALE:40X

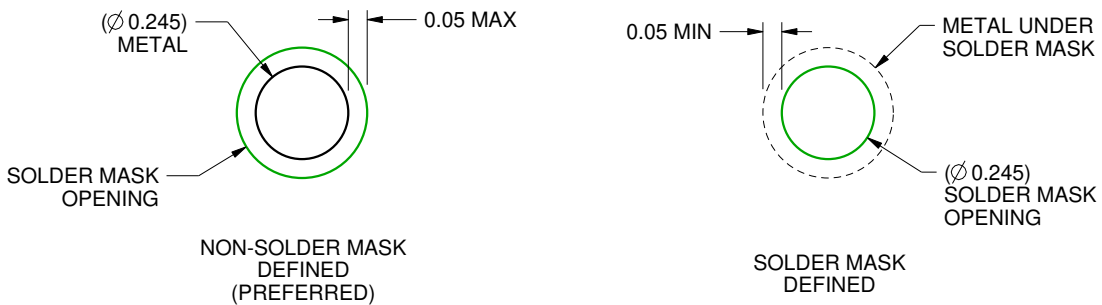

SOLDER MASK DETAILS
NOT TO SCALE

4223221/A 08/2016

NOTES: (continued)

- Final dimensions may vary due to manufacturing tolerance considerations and also routing constraints. See Texas Instruments Literature No. SNVA009 (www.ti.com/lit/snva009).

EXAMPLE STENCIL DESIGN

YZF0004

DSBGA - 0.625 mm max height

DIE SIZE BALL GRID ARRAY

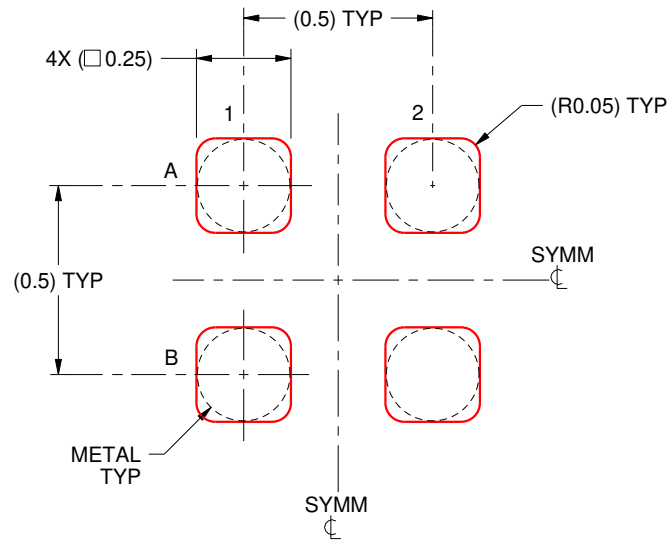

SOLDER PASTE EXAMPLE
BASED ON 0.1 mm THICK STENCIL
SCALE:50X

4223221/A 08/2016

NOTES: (continued)

4. Laser cutting apertures with trapezoidal walls and rounded corners may offer better paste release.

IMPORTANT NOTICE AND DISCLAIMER

TI PROVIDES TECHNICAL AND RELIABILITY DATA (INCLUDING DATA SHEETS), DESIGN RESOURCES (INCLUDING REFERENCE DESIGNS), APPLICATION OR OTHER DESIGN ADVICE, WEB TOOLS, SAFETY INFORMATION, AND OTHER RESOURCES "AS IS" AND WITH ALL FAULTS, AND DISCLAIMS ALL WARRANTIES, EXPRESS AND IMPLIED, INCLUDING WITHOUT LIMITATION ANY IMPLIED WARRANTIES OF MERCHANTABILITY, FITNESS FOR A PARTICULAR PURPOSE OR NON-INFRINGEMENT OF THIRD PARTY INTELLECTUAL PROPERTY RIGHTS.

These resources are intended for skilled developers designing with TI products. You are solely responsible for (1) selecting the appropriate TI products for your application, (2) designing, validating and testing your application, and (3) ensuring your application meets applicable standards, and any other safety, security, regulatory or other requirements.

These resources are subject to change without notice. TI grants you permission to use these resources only for development of an application that uses the TI products described in the resource. Other reproduction and display of these resources is prohibited. No license is granted to any other TI intellectual property right or to any third party intellectual property right. TI disclaims responsibility for, and you will fully indemnify TI and its representatives against, any claims, damages, costs, losses, and liabilities arising out of your use of these resources.

TI's products are provided subject to [TI's Terms of Sale](#) or other applicable terms available either on ti.com or provided in conjunction with such TI products. TI's provision of these resources does not expand or otherwise alter TI's applicable warranties or warranty disclaimers for TI products.

TI objects to and rejects any additional or different terms you may have proposed.

Mailing Address: Texas Instruments, Post Office Box 655303, Dallas, Texas 75265
Copyright © 2022, Texas Instruments Incorporated