

MS415-20*

DRAWN-SEAMLESS EMI/RFI SHIELD

*OPTIONAL SHIELD CONFIGURATIONS

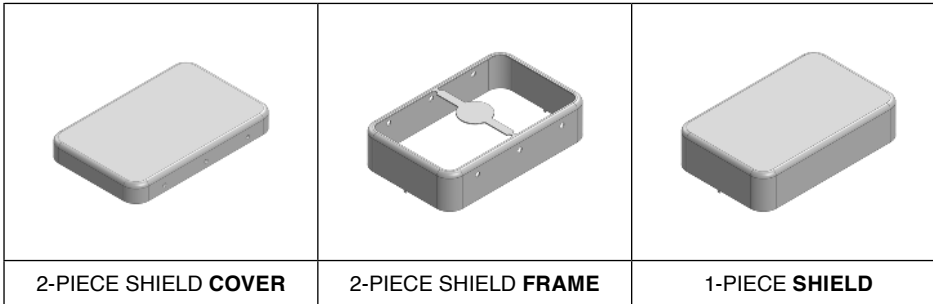

ITEM P/N	ITEM DESCRIPTION	MATERIAL
MS415-20C	2-PIECE EMI/RFI SHIELD COVER	TIN-PLATED STEEL
MS415-20F	2-PIECE EMI/RFI SHIELD FRAME	TIN-PLATED STEEL
MS415-20S	1-PIECE EMI/RFI SHIELD	TIN-PLATED STEEL
MS415-20C-NS	2-PIECE EMI/RFI SHIELD COVER	NICKEL-SILVER
MS415-20F-NS	2-PIECE EMI/RFI SHIELD FRAME	NICKEL-SILVER
MS415-20S-NS	1-PIECE EMI/RFI SHIELD	NICKEL-SILVER

TIN-PLATED STEEL: CRS ELECTROLYTIC TINPLATE

NICKEL-SILVER: UNS C77000 / UNS C73500



SHIELD CONFIGURATION:

MATERIAL:

© MASACH TECH LTD.
22 HAGANAN, MODIIN 7169513 ISRAEL
T: (+972) 8-9754681 / F: (+972) 8-9754682
info@masach.com / www.masach.com

SHIELD TYPE:

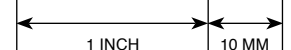



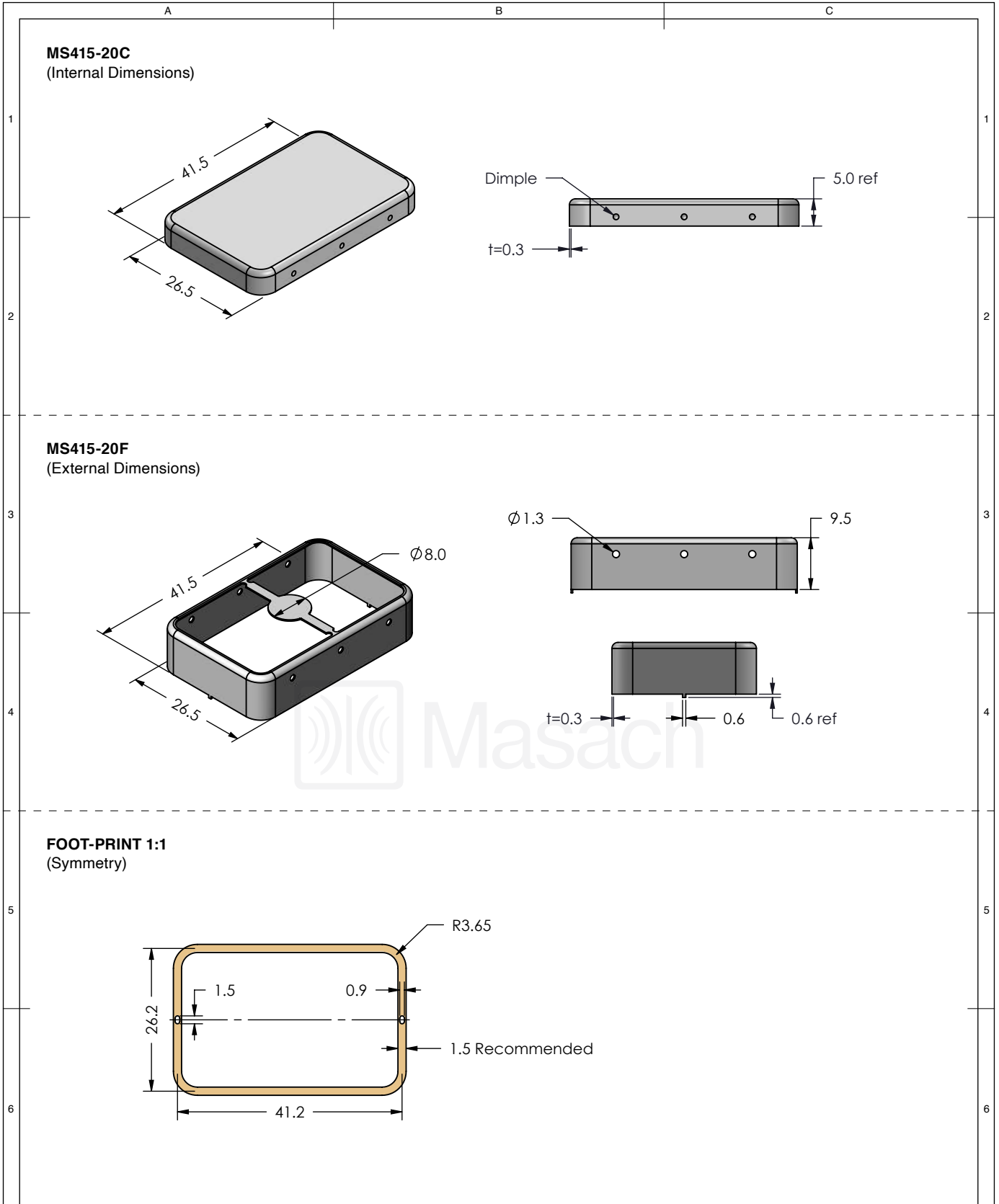

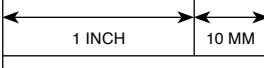
MMGS / PRINT 1:1 / A4

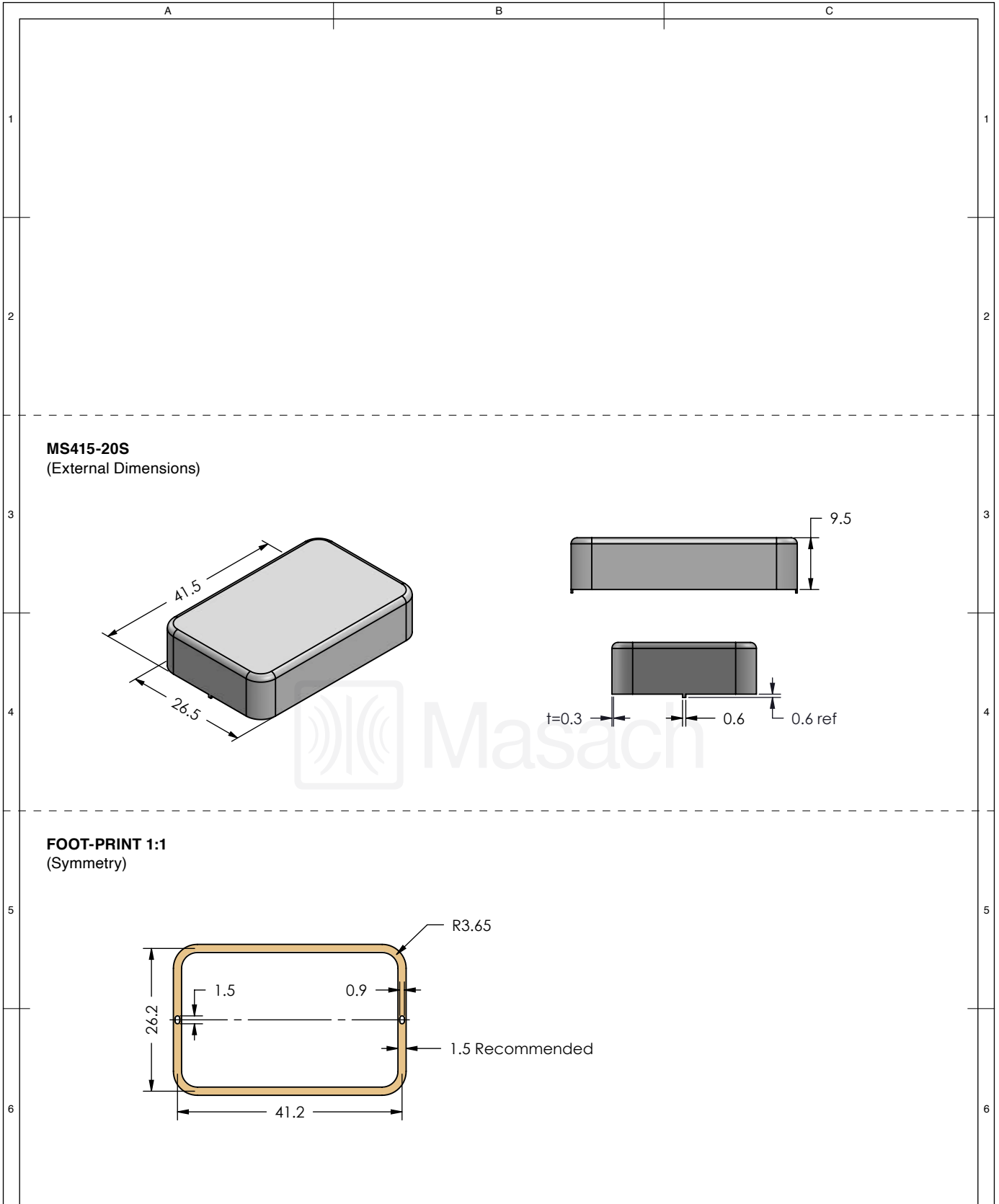

	SHIELD CONFIGURATION:		MATERIAL:	
	2-PIECE EM/RFI SHIELD		TIN-PLATED STEEL ⁽¹⁾	
	NOTE: (1) CRS ELECTROLYTIC TINPLATE (2) GENERAL TOLERANCE (+/-) 0.2MM			
© MASACH TECH LTD. 22 HAGANAN, MODIIN 7169513 ISRAEL T: (+972) 8-9754681 / F: (+972) 8-9754682 info@masach.com / www.masach.com	SHIELD TYPE:		 	
	DRAWN-SEAMLESS EM/RFI SHIELD			

This product has been designed and manufactured by © Masach Tech Ltd. The use of this product in any type of electronic device or application is not under Masach Tech Ltd. liability.

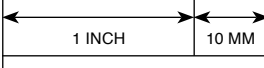

	SHIELD CONFIGURATION:	MATERIAL:
	1-PIECE EM/RFI SHIELD	TIN-PLATED STEEL ⁽¹⁾
NOTE: (1) CRS ELECTROLYTIC TINPLATE (2) GENERAL TOLERANCE (+/-) 0.2MM		
© MASACH TECH LTD. 22 HAGANAN, MODIIN 7169513 ISRAEL T: (+972) 8-9754681 / F: (+972) 8-9754682 info@masach.com / www.masach.com	SHIELD TYPE:	 
	DRAWN-SEAMLESS EM/RFI SHIELD	
MMGS / PRINT 1:1 / A4		

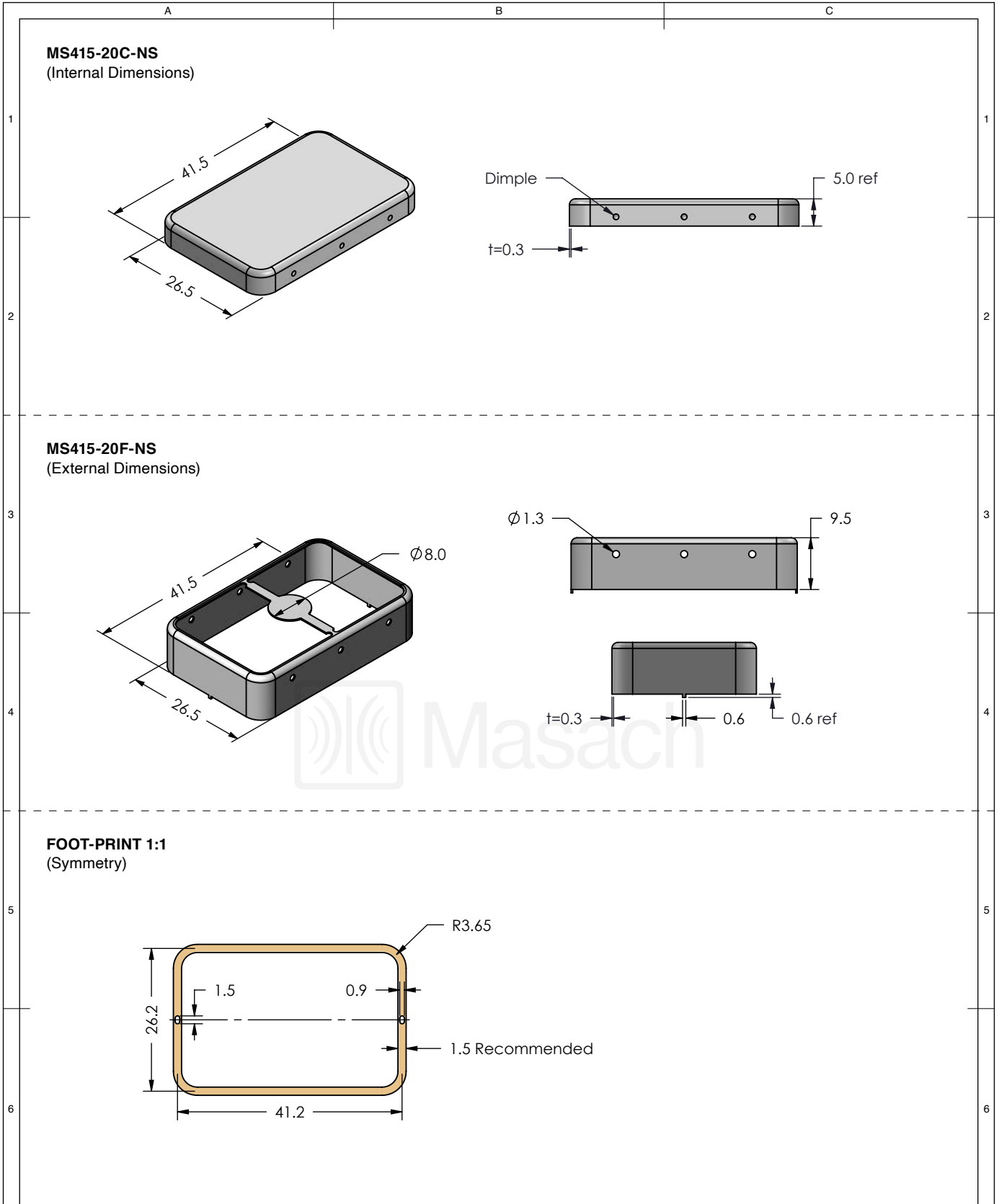

This product has been designed and manufactured by © Masach Tech Ltd. The use of this product in any type of electronic device or application is not under Masach Tech Ltd. liability.

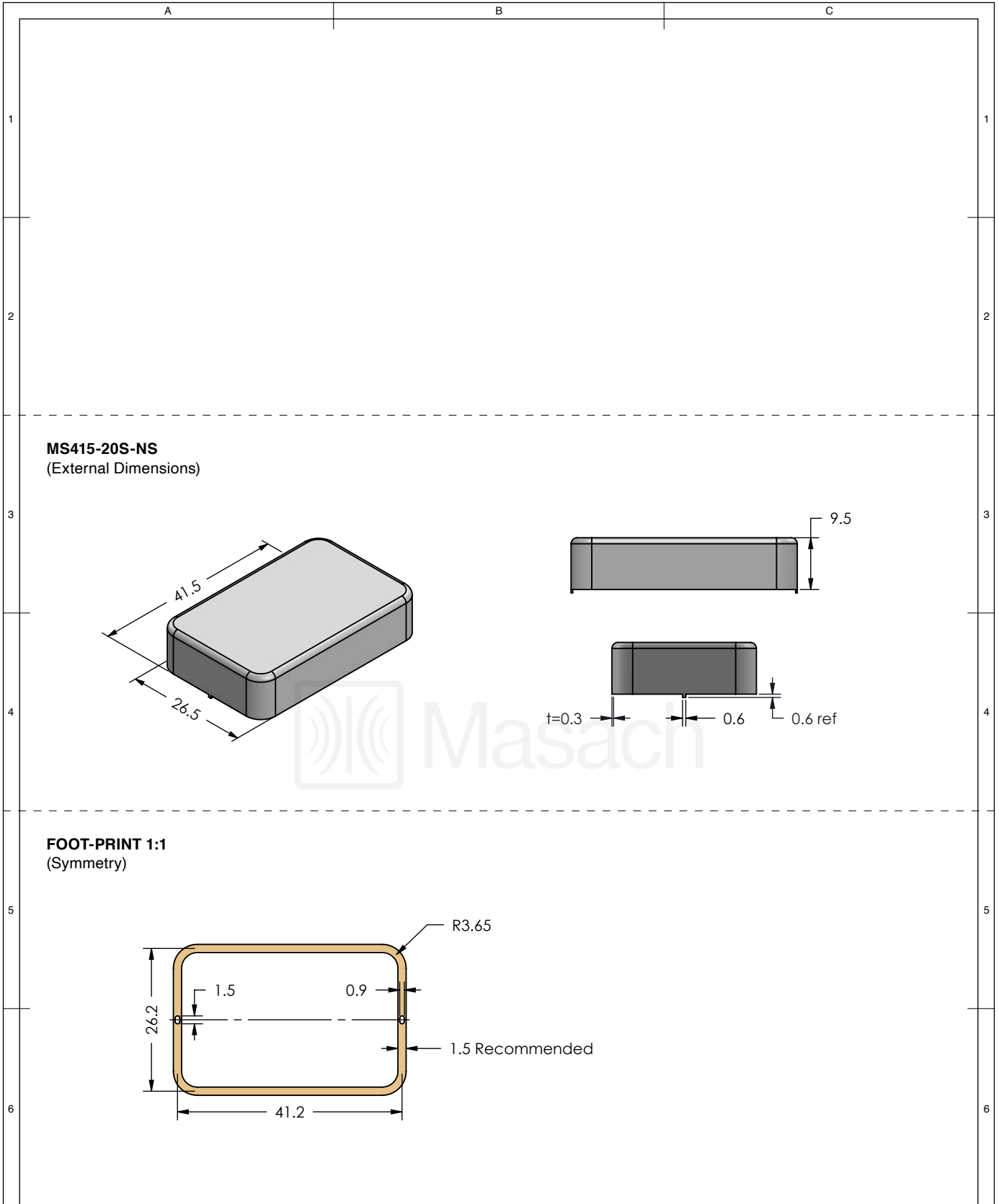

	SHIELD CONFIGURATION:		MATERIAL:	
	2-PIECE EM/RFI SHIELD		NICKEL-SILVER ⁽¹⁾	
	NOTE: (1) UNS C77000 / UNS C73500 (2) GENERAL TOLERANCE (+/-) 0.2MM			
© MASACH TECH LTD. 22 HAGANAN, MODIIN 7169513 ISRAEL T: (+972) 8-9754681 / F: (+972) 8-9754682 info@masach.com / www.masach.com	SHIELD TYPE:		 	
	DRAWN-SEAMLESS EM/RFI SHIELD			

This product has been designed and manufactured by © Masach Tech Ltd. The use of this product in any type of electronic device or application is not under Masach Tech Ltd. liability.

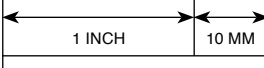

	SHIELD CONFIGURATION:		MATERIAL:	
	1-PIECE EM/RFI SHIELD		NICKEL-SILVER ⁽¹⁾	
	NOTE: (1) UNS C77000 / UNS C73500 (2) GENERAL TOLERANCE (+/-) 0.2MM			
© MASACH TECH LTD. 22 HAGANAN, MODIIN 7169513 ISRAEL T: (+972) 8-9754681 / F: (+972) 8-9754682 info@masach.com / www.masach.com	SHIELD TYPE:		 	
	DRAWN-SEAMLESS EM/RFI SHIELD			

This product has been designed and manufactured by © Masach Tech Ltd. The use of this product in any type of electronic device or application is not under Masach Tech Ltd. liability.

A

B

C

MS415-20* SMT/SMD PACKING TRAY

* COMPATIBLE TO ALL SHIELD CONFIGURATIONS

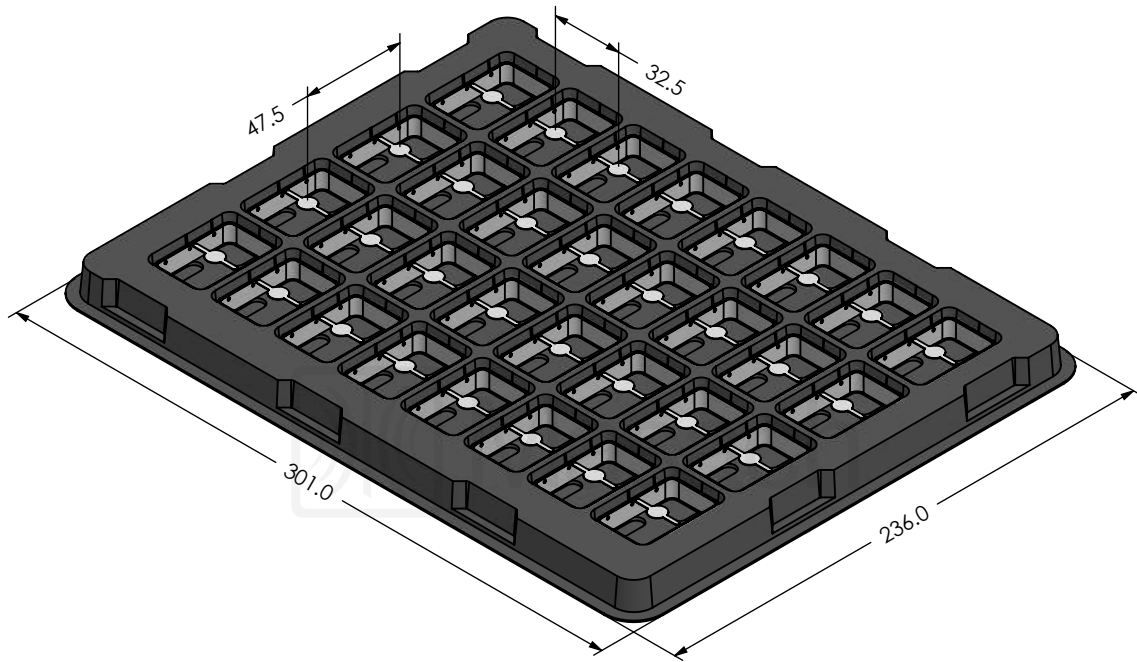

1

1

2

2

3

3

4

4

5

5

6

6



SHIELD CONFIGURATION:

MATERIAL:

© MASACH TECH LTD.
 22 HAGANAN, MODIIN 7169513 ISRAEL
 T: (+972) 8-9754681 / F: (+972) 8-9754682
info@masach.com / www.masach.com

SHIELD TYPE:

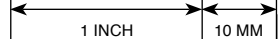

MMGS / PRINT 1:1 / A4

This product has been designed and manufactured by © Masach Tech Ltd. The use of this product in any type of electronic device or application is not under Masach Tech Ltd. liability.

[BACK TO TOP](#)