

FH64MA Series

0.25mm Pitch, 0.5mm Height, Top Contact, Super Low Profile Back Flip FPC Connector

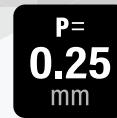

™ Flip-Lock Pioneer Hirose



P= 0.25mm

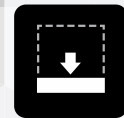

Ultra Low Profile



Back Flip

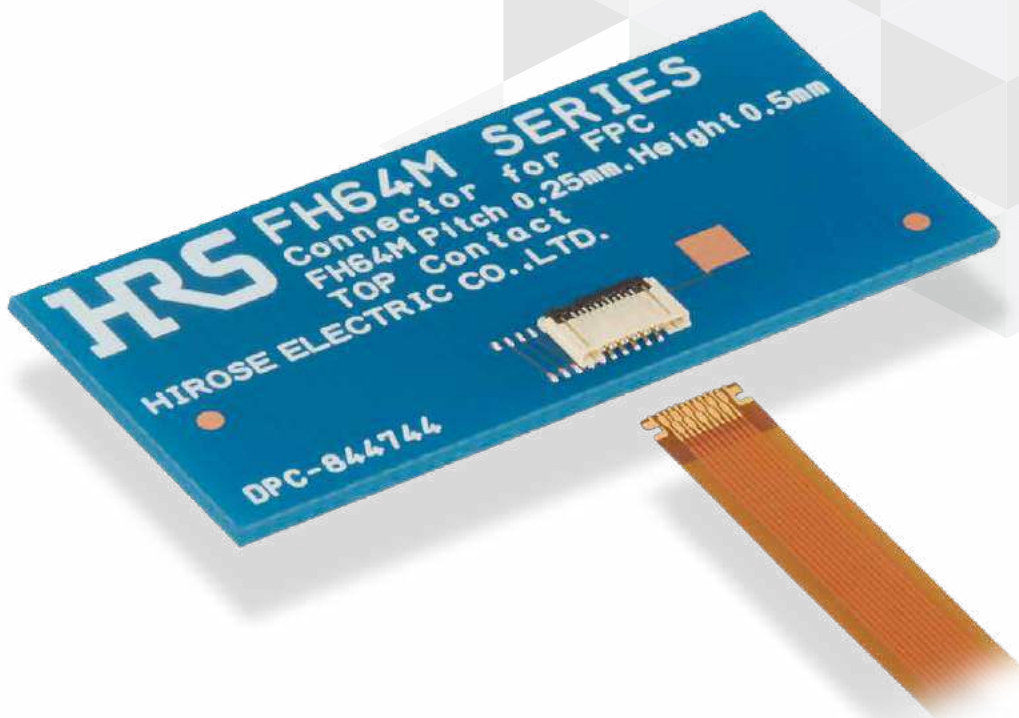

Features

1. Super Low Profile, Top Contact Connector

Low profile, top contact connector with a height of 0.5mm.

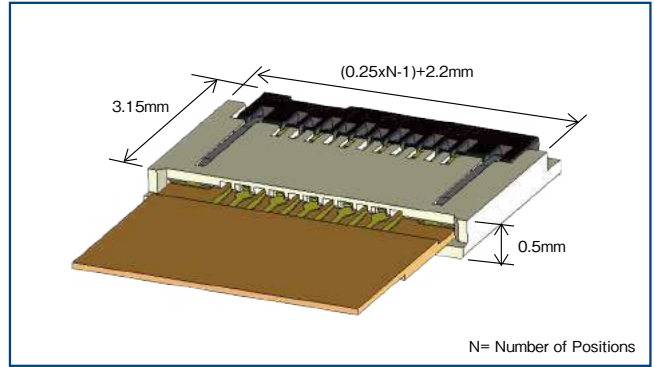

2. Space-saving

A pitch of 0.25mm and width of 3.15mm (when actuator is locked) for ultimate space-saving.

3. Superior FPC Insertion

The mating guides on the connector allow for smooth FPC insertion while maintaining a low product profile.

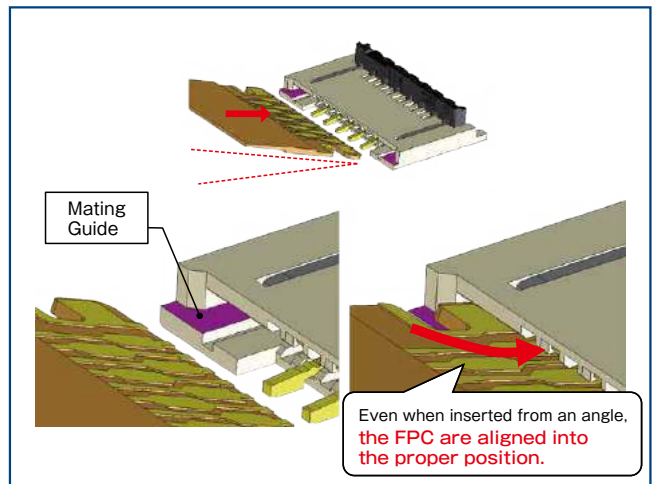

4. High FPC Retention Force

The notches on both sides of the FPC are held by retention tabs for high FPC retention even at smaller pin counts.



5. Narrow Pitch and Easy to Manufacture FPC

With the same deviation tolerance as 0.3mm pitch products at a pitch of 0.25mm, a narrower pitch is possible without increasing the cost.

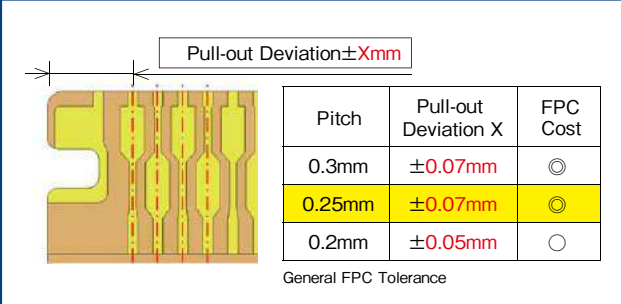

Pull-out Deviation $\pm Xmm$

Pitch	Pull-out Deviation X	FPC Cost
0.3mm	$\pm 0.07mm$	○
0.25mm	$\pm 0.07mm$	◎
0.2mm	$\pm 0.05mm$	○

General FPC Tolerance

General FPC Tolerance

6. Original FPC Mis-Mating Detection Design

FPC insertion status can be checked with the FPC pattern for mis-mating detection.

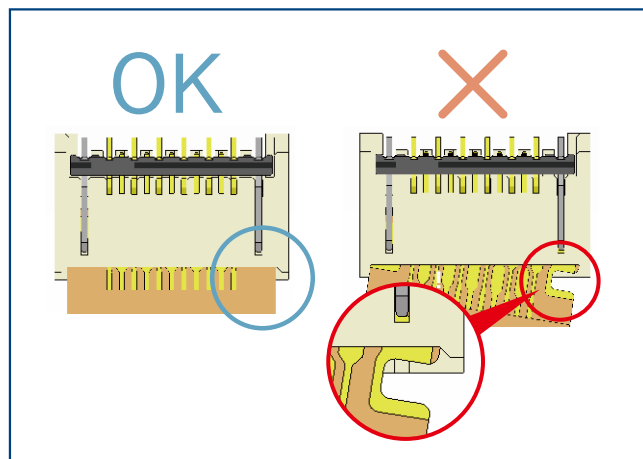

7. Halogen-free

Connector does not use chlorine or bromine above the standard value.

*AS defined by IEC 61249-2-21.

Br : 900ppm Max., Cl : 900ppm Max.,

Br+Cl : 1,500ppm Max.

Product Specifications

Rated Current	0.2A	Operating Temperature (Note 1)	-55 to +85°C
		Operating Humidity Range	Relative humidity 90% RH or less (No Condensation)
Rated Voltage	30V AC/DC	Storage Temperature(Note 2)	-10 to +50°C
		Storage Humidity Range(Note 2)	Relative humidity 90% RH or less (No Condensation)

Compatible FPC Specifications	t = 0.12 ± 0.02mm Gold Plated
-------------------------------	-------------------------------

Item	Specifications	Conditions
Insulation Resistance	50M Ω Min.	Measured at 100V DC
Withstanding Voltage	No flashover or insulation breakdown	90V AC for 1 min.
Contact Resistance	200m Ω Max. *Includes FPC resistance.	Measured at 1mA AC
Mating Durability	Contact Resistance : 200m Ω Max. No damage, cracks or part dislocation.	10 times
Vibration Resistance	No electrical discontinuity of 1 μ s Min. Contact Resistance : 200m Ω Max. No damage, cracks or part dislocation.	Frequency : 10 to 55 Hz, single amplitude of 0.75mm, 10 cycles in each of the 3 axis
Shock Resistance	No electrical discontinuity of 1 μ s Min. Contact Resistance : 200m Ω Max. No damage, cracks or part dislocation.	Acceleration of 981m/s ² , 6 ms duration, sine halfwave, 3cycles in each of the 3 axis
Steady State Moisture Resistance	Contact Resistance : 200m Ω Max. Insulation Resistance : 50M Ω Min. No damage, cracks or part dislocation.	Left for 96 hours at 40°C and humidity of 90 to 95%
Temperature Cycle	Contact Resistance : 200m Ω Max. Insulation Resistance : 50M Ω Min. No damage, cracks or part dislocation.	Temperature : -55 → +15 to +35 → +85 → +15 to +35°C Time : 30 → 2 to 3 → 30 → 2 to 3 minutes Above conditions repeated for 5 cycles
Soldering Heat Resistance	No deformation in appearance or significant damage to contacts.	Reflow : Refer to the recommended temperature profile Number of reflow times : 2 or less Manual soldering : 350°C± 10°C for 5 seconds

Note 1 : Includes temperature rise due to current flow.

Note 2 : Storage refers to the long-term storage condition of unused products prior to PCB mounting.

The operating temperature and humidity range are applicable to the non-energized state after PCB mounting.

Materials / Finish

Component	Material	Color/Finish	UL Standard
Insulator	LCP	Beige	UL94V-0
	Polyamide Resin	Black	UL94V-0
Contact	Phosphor Bronze	Nickel Barrier Gold Plated	—
Retention Tab	Phosphor Bronze	Pure Tin Reflow Plated	—

Product Number Structure

Refer to the chart below when determining the product specifications from the product number.
Please select from the product numbers listed in this catalog when placing orders.

FH64MA - ##S - 0.25 SHW (##)

① ② ③ ④ ⑤

① Series Name	FH64MA	④ Contact Design	SHW : SMT Horizontal Staggered Mounting Type
② No. of Pos.	5-31	⑤ Specifications	(00) : Standard, 5,000pcs per reel (99) : 500pcs per reel
③ Contact Pitch	0.25mm		

Connector Dimensions

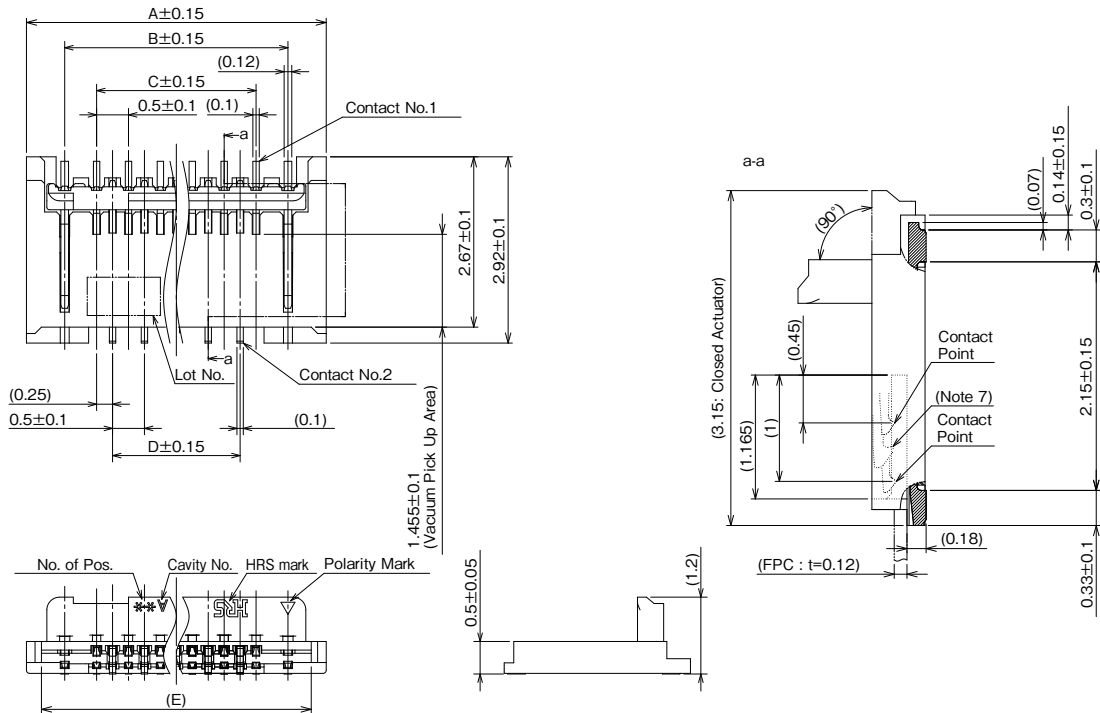

- Notes :
1. The dimensions in parentheses are for reference.
 2. The coplanarity of the contact and retention tab lead should be 0.1mm Max.
 3. Packaged in tape and reel. Check the packaging specifications for details.
 4. Sink holes or slits may be added for improvements.
 5. Black spots may appear on the mold however this does not represent a quality issue.
 6. This product is halogen-free.
(Br : 900ppm maximum, Cl : 900ppm maximum, Cl + Br combined : 1,500ppm maximum)
 7. Represents the hook shape of the locking retention tabs.

Unit : mm

Part No.	HRS No.	No. of Pos.	A	B	C	D	E	Purchase Unit	
								(##) : (00)	(##) : (99)
FH64MA-5S-0.25SHW(##)	CL0580-4643-0-##	5	3.2	2.0	1.0	0.5	2.73	5,000pcs per reel	500pcs per reel
FH64MA-7S-0.25SHW(##)	CL0580-4610-0-##	7	3.7	2.5	1.5	1.0	3.23		
FH64MA-9S-0.25SHW(##)	Under Planning (Note)	9	4.2	3.0	2.0	1.5	3.73		
FH64MA-11S-0.25SHW(##)	CL0580-4612-0-##	11	4.7	3.5	2.5	2.0	4.23		
FH64MA-13S-0.25SHW(##)	Under Planning (Note)	13	5.2	4.0	3.0	2.5	4.73		
FH64MA-15S-0.25SHW(##)	CL0580-4608-0-##	15	5.7	4.5	3.5	3.0	5.23		
FH64MA-17S-0.25SHW(##)	Under Planning (Note)	17	6.2	5.0	4.0	3.5	5.73		
FH64MA-19S-0.25SHW(##)	CL0580-4616-0-##	19	6.7	5.5	4.5	4.0	6.23		
FH64MA-21S-0.25SHW(##)	Under Planning (Note)	21	7.2	6.0	5.0	4.5	6.73		
FH64MA-23S-0.25SHW(##)	Under Planning (Note)	23	7.7	6.5	5.5	5.0	7.23		
FH64MA-25S-0.25SHW(##)	CL0580-4642-0-##	25	8.2	7.0	6.0	5.5	7.73		
FH64MA-31S-0.25SHW(##)	Under Planning (Note)	31	9.7	8.5	7.5	7.0	9.23		

Note : Products without HRS No. are currently being planned for development.
Please contact a Hirose representative regarding questions on pin count variation development.

Recommended Land Pattern

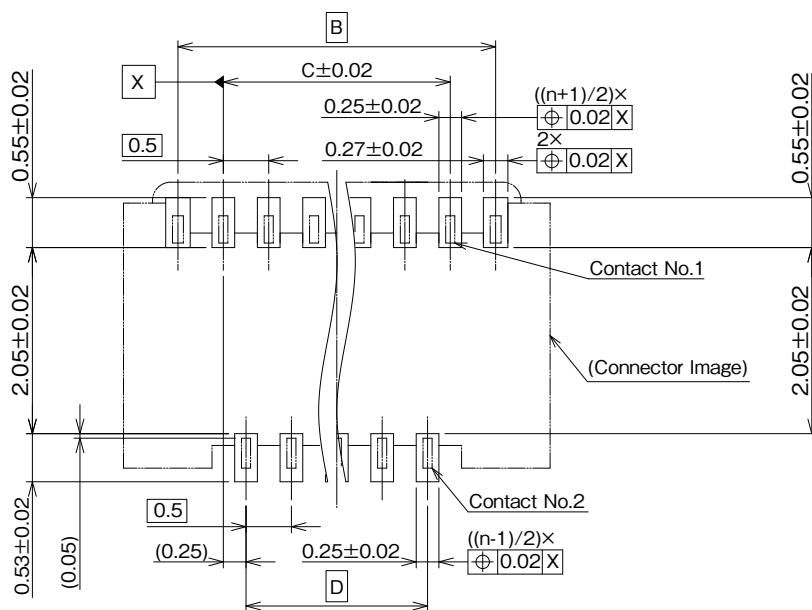

Recommended Metal Mask Dimensions

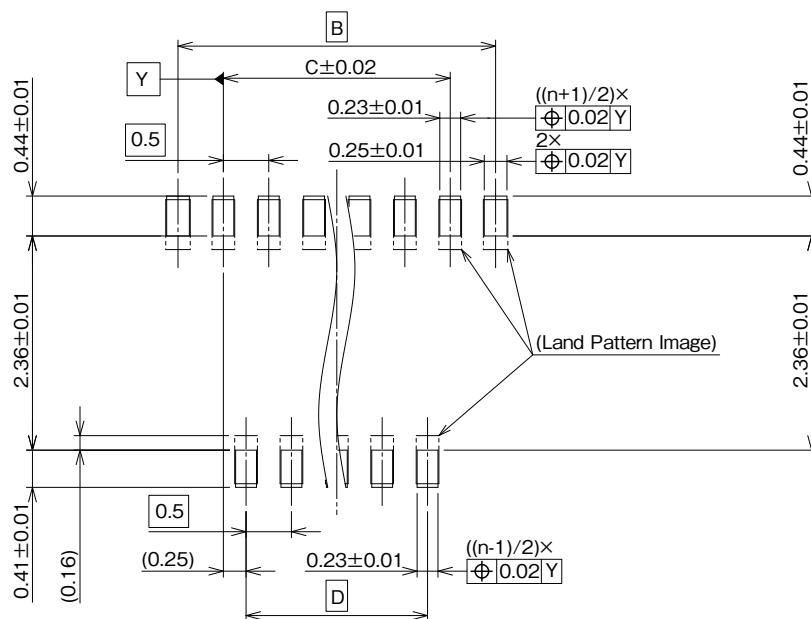

Note 8 : 'n' represents the number of positions.

Unit : mm

Part No.	HRS No.	No. of Pos.	B	C	D
FH64MA-5S-0.25SHW(##)	CL0580-4643-0-##	5	2.0	1.0	0.5
FH64MA-7S-0.25SHW(##)	CL0580-4610-0-##	7	2.5	1.5	1.0
FH64MA-9S-0.25SHW(##)	Under Planning (Note)	9	3.0	2.0	1.5
FH64MA-11S-0.25SHW(##)	CL0580-4612-0-##	11	3.5	2.5	2.0
FH64MA-13S-0.25SHW(##)	Under Planning (Note)	13	4.0	3.0	2.5
FH64MA-15S-0.25SHW(##)	CL0580-4608-0-##	15	4.5	3.5	3.0
FH64MA-17S-0.25SHW(##)	Under Planning (Note)	17	5.0	4.0	3.5
FH64MA-19S-0.25SHW(##)	CL0580-4616-0-##	19	5.5	4.5	4.0
FH64MA-21S-0.25SHW(##)	Under Planning (Note)	21	6.0	5.0	4.5
FH64MA-23S-0.25SHW(##)	Under Planning (Note)	23	6.5	5.5	5.0
FH64MA-25S-0.25SHW(##)	CL0580-4642-0-##	25	7.0	6.0	5.5
FH64MA-31S-0.25SHW(##)	Under Planning (Note)	31	8.5	7.5	7.0

Note : Products without HRS No. are currently being planned for development.

Please contact a Hirose representative regarding questions on pin count variation development.

Recommended FPC Construction

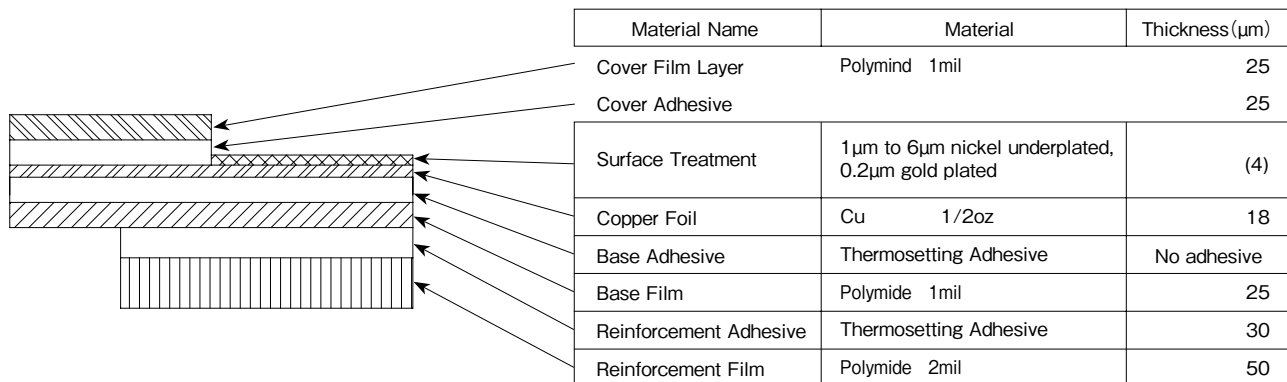

Note 1 : This is a reference FPC construction.

Make the thickness of the FPC mated portion 0.12 ± 0.02 mm in reference to the FPC construction.

Note 2 : Contact an FPC maker for details on component construction.

Packaging Specifications

● Embossed Carrier Tape Dimensions

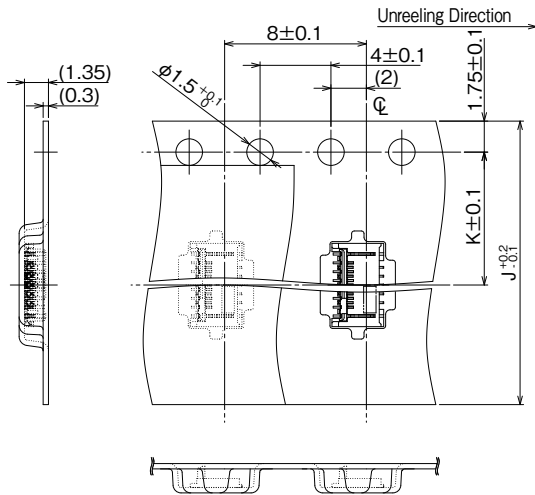

● Reel Dimensions

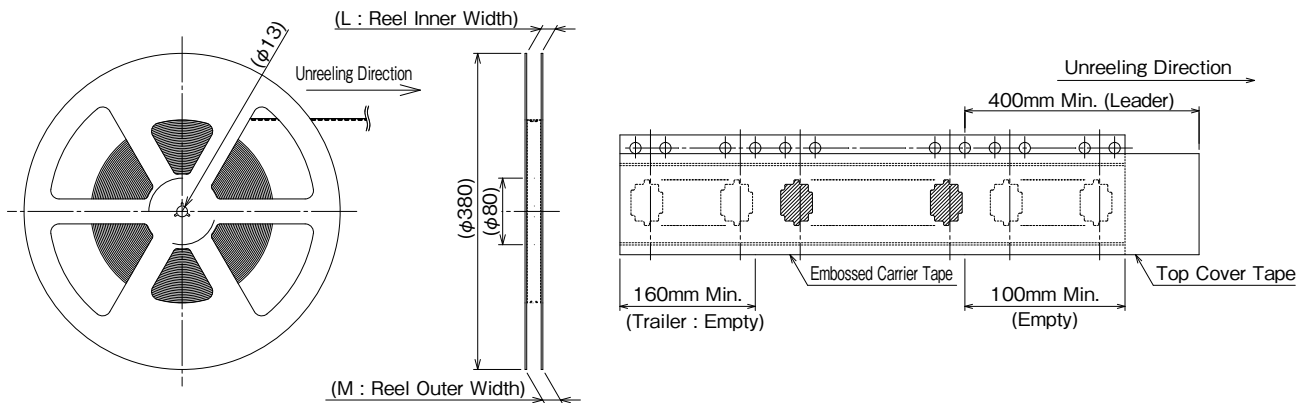

Unit : mm

Part No.	HRS No.	No. of Pos.	J	K	L	M
FH64MA-5S-0.25SHW(##)	CL0580-4643-0-##	5	16.0	7.5	17.4	21.4
FH64MA-7S-0.25SHW(##)	CL0580-4610-0-##	7	16.0	7.5	17.4	21.4
FH64MA-9S-0.25SHW(##)	Under Planning (Note)	9	16.0	7.5	17.4	21.4
FH64MA-11S-0.25SHW(##)	CL0580-4612-0-##	11	16.0	7.5	17.4	21.4
FH64MA-13S-0.25SHW(##)	Under Planning (Note)	13	16.0	7.5	17.4	21.4
FH64MA-15S-0.25SHW(##)	CL0580-4608-0-##	15	16.0	7.5	17.4	21.4
FH64MA-17S-0.25SHW(##)	Under Planning (Note)	17	16.0	7.5	17.4	21.4
FH64MA-19S-0.25SHW(##)	CL0580-4616-0-##	19	16.0	7.5	17.4	21.4
FH64MA-21S-0.25SHW(##)	Under Planning (Note)	21	24.0	11.5	25.4	29.4
FH64MA-23S-0.25SHW(##)	Under Planning (Note)	23	24.0	11.5	25.4	29.4
FH64MA-25S-0.25SHW(##)	CL0580-4642-0-##	25	24.0	11.5	25.4	29.4
FH64MA-31S-0.25SHW(##)	Under Planning (Note)	31	24.0	11.5	25.4	29.4

Note : Products without HRS No. are currently being planned for development.
Please contact a Hirose representative regarding questions on pin count variation development.

Temperature Profile

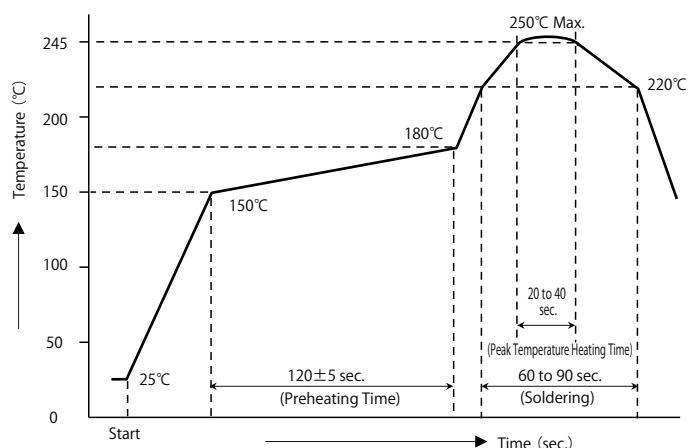

Applicable Conditions

Reflow Method : IR/Hot Air

Reflow Environment : Room Air

Environment :

Solder : Paste SN/3.0Ag/0.5Cu
(Senju Metal Industry, Co. Ltd Part Number: M705-GRN360-K2-V)

Test Board : Test Board Material and Size
Glass epoxy 32.85 × 15.7 × 1mm
Land size as listed on "Recommended Land Pattern".

Metal Mask : Recommended thickness and aperture dimensions as listed on "Recommended Metal Mask Dimensions".

This temperature profile is for the above conditions. The temperature profile may vary depending on the type of cream solder, the manufacturer, the board size and other conditions such as mounting materials. Please check the mounting status before use.

Connector Operation and Precautions

[Operating Method]

This connector is a compact, low profile product and requires care during handling. Check the following before use.

1. Initial Delivery State

Since the product is delivered with the actuator open, there is no need to operate the actuator before FPC insertion.

[Cautions]

- Do not close the actuator without the FPC inserted.
Closing the actuator without the FPC inserted causes the contact gap to narrow and may result in a higher FPC insertion force.
- Do not operate the connector while it is not mounted on the board.

2. FPC Insertion Method

Insert the FPC fully to the back of the connector and parallel in respect to the board. (Ex. 1)

[Cautions]

- Do not insert the FPC while the actuator is closed. (Ex. 2)
- Do not twist upwards or downwards or to either side during FPC insertion.

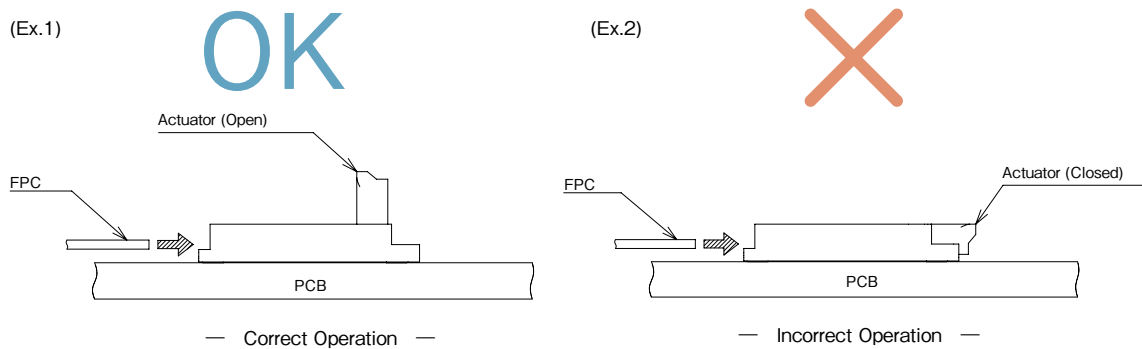

3. FPC Insertion Confirmation

Visually confirm the insertion status once FPC insertion is completed. (Ex.3)

[Caution]

· Avoid shallow insertion or insertion at a slant. (Ex.4) (Ex.5)

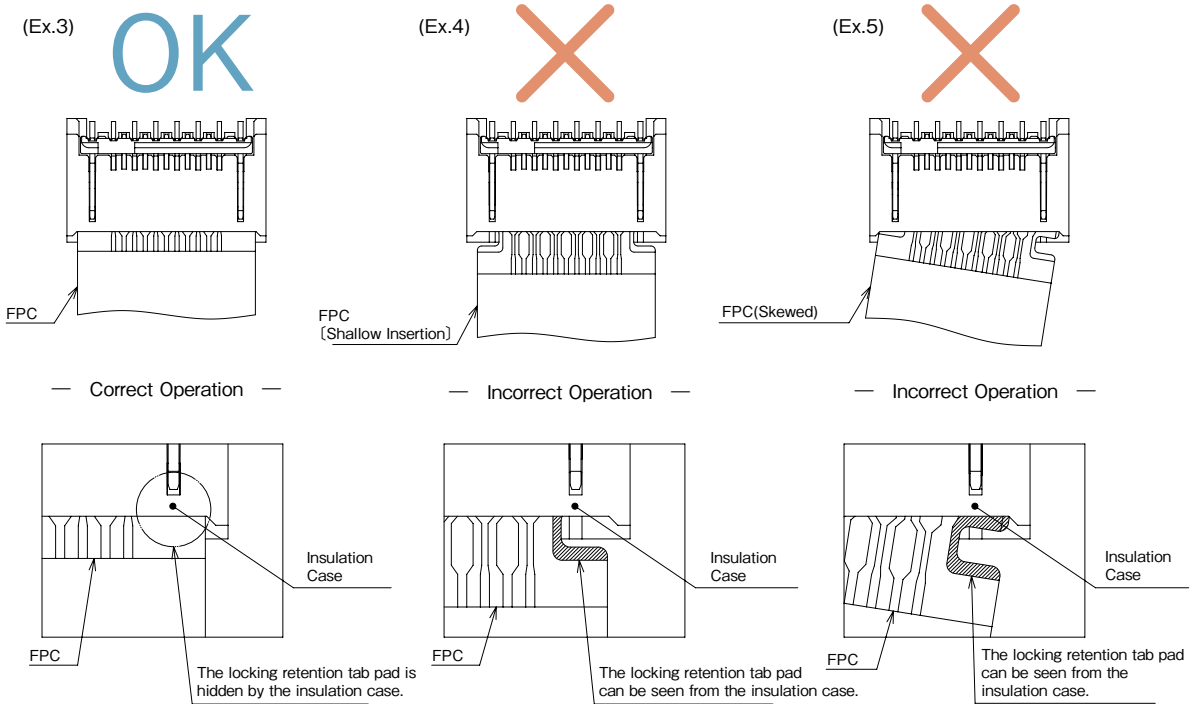

4. Actuator Locking Method

The actuator rotates at its center.

After FPC insertion, operate the actuator by rotating it 90°.

[Cautions]

- When locking, operate the actuator close to its center. (Ex.6)
- When locking, do not operate the actuator only on one side. (Ex.7)
- Do not operate the actuator by pushing from above. (Ex.8)
- Do not apply excessive force to the housing during operation. (Ex.9)

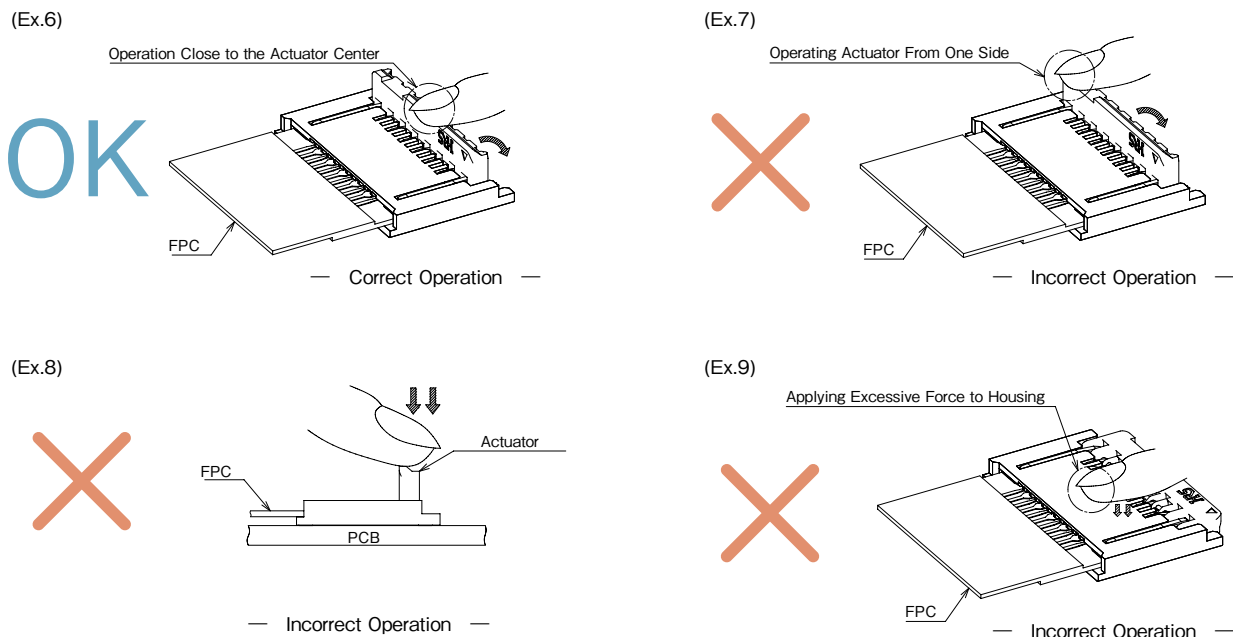

5. Actuator Lock Release Method

Slowly raise the actuator and release the lock. (Ex. 10)

[Cautions]

- When unlocking, operate the actuator close to its center. (Ex. 11)
- When unlocking, do not operate the actuator on only one side. (Ex. 12)
- The actuator only opens to 90°. Do not try to open the actuator above this angle. (Ex. 13)
- This connector has a back flip design. The FPC insertion direction and actuator opening are in different directions. Do not attempt to open the actuator from the FPC insertion side. (Ex. 14)

(Ex.10)

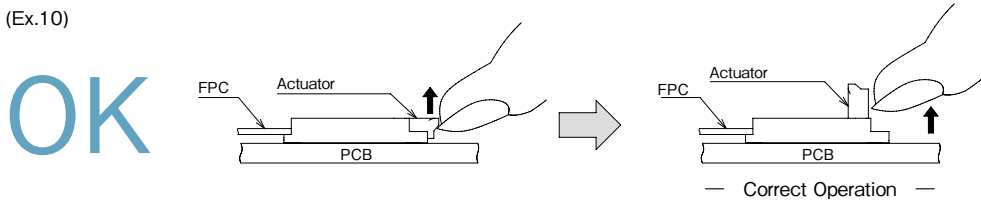

(Ex.11)

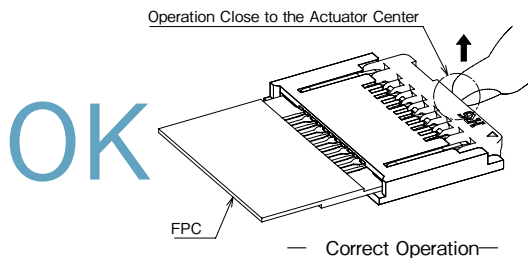

(Ex.12)

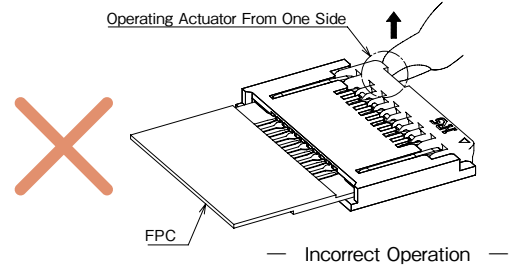

(Ex.13)

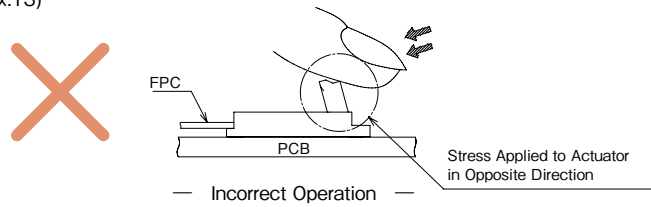

(Ex.14)

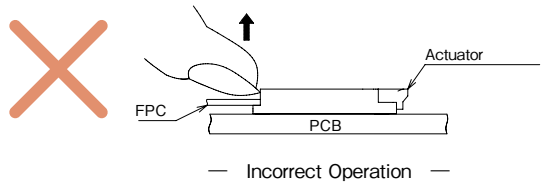

6. FPC Removal Method

After releasing the actuator lock, pull the FPC out in the horizontal direction. (Ex. 15)

[Cautions]

- Do not apply stress in the upward direction or the sides when removing the FPC. (Ex. 16)
- Do not pull out the FPC while the actuator is locked. (Ex. 17)

(Ex.15)

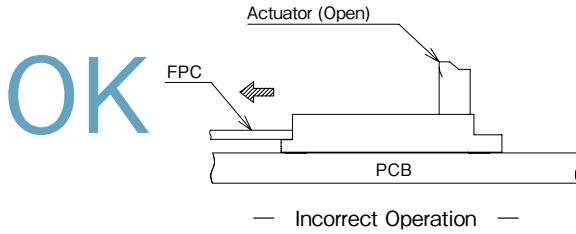

(Ex.16)

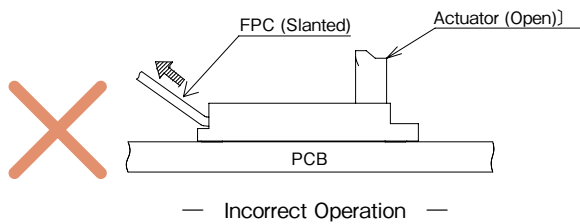

(Ex.17)

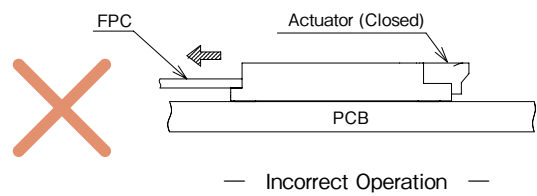

7. FPC Routing

Depending on how the FPC that will be mated is routed, stress may be applied to the connector, resulting in poor performance including contact failure. In order to prevent failure, please consider the following when designing.

[Cautions]

- When routing the FPC for use, make sure it has enough slack and do not pull tightly. Make sure that the reinforcing film is horizontal to the board surface. (Ex. 18)
- Make sure not to apply stress to the connector in the pulling, inserting or lateral directions. (Ex. 19) (Ex. 20)
- When routing the FPC for use, route it so that stress is not directly applied to the connector. (Ex. 19)
- Do not place mounted parts that interfere with the FPC. (Ex. 21)

(Ex.18)

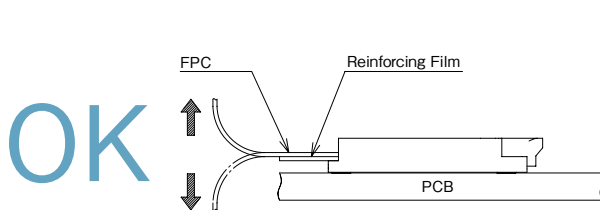

(Ex.19)

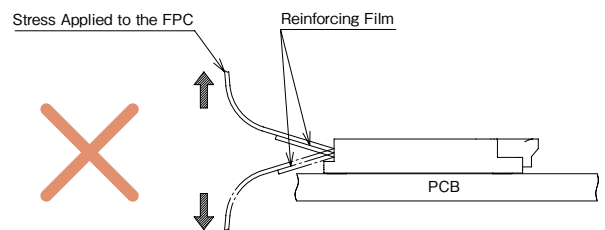

(Ex.20)

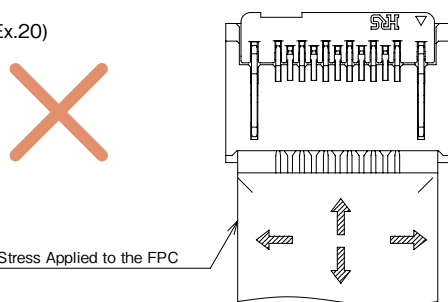

(Ex.21)

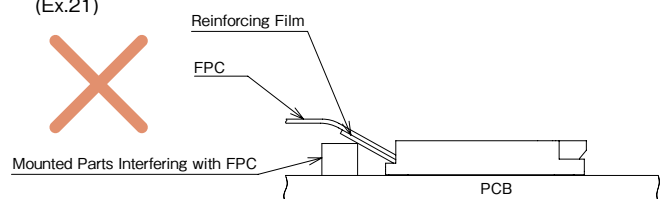

[PCB Mounting Cautions]

- PCB Warpage
 - Minimize PCB warpage as much as possible.
 - Lead co-planarity is 0.1mm or less, however too much warpage may result in a soldering failure.
- Mounting to FPC
 - When mounting on the FPC, be sure to install a reinforcing plate that is easy to handle.
 - A glass epoxy material with a thickness of 0.3mm Min. is recommended.
- Stress to Connector
 - Do not apply an external force of 0.5N or more prior to mounting as it may result in connector damage.
 - Additionally, do not insert the FPC or operate the connector prior to mounting.
- Load to PCB
 - Splitting a large PCB into several pieces
 - Screwing the PCB
 - Avoid the handling described above so that no force is exerted on the PCB during the assembly process.
 - Otherwise, the connector may be damaged.

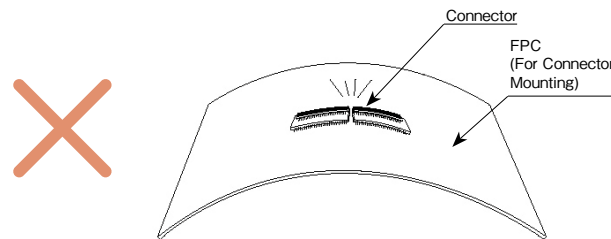

- Cautions for Manual Soldering
 - Note the following when performing soldering during repair, etc.
 - ① Do not perform reflow or manual soldering with the FPC inserted in the connector.
 - ② Do not apply excessive heat to the connector or let the soldering iron in contact with any parts other than the contact leads. Failure to do so may result in connector deformation or melting.
 - ③ Do not supply excessive solder (flux).
 - If excessive solder (flux) is applied to the contacts solder or flux may adhere to the contacts or the rotating portion of the actuator, resulting in poor contact or poor actuator rotation.
 - Supplying excessive solder to the locking retention tabs may result in actuator rotation failure, causing connector damage.

While Taking into Consideration

Specifications mentioned in this catalog are reference values.

When considering to order or use this product, please confirm the Drawing and Product Specifications sheets.

Use an appropriate cable when using the connector in combination with cables.

If considering usage of a non-specified cable, please contact your sales representative.

If assembly process is done by jigs & tools which are not identified by Hirose, assurance will not be given.

If considering usage for below mentioned applications, please contact your sales representative.

In cases where the application will demand a high level of reliability, such as automotive, medical instruments, public infrastructure, aerospace/ defense etc. Hirose must review before assurance of reliability can be given.