

Schottky Rectifier, 20 A

TO-220AC

FEATURES

- 125 °C T_J operation ($V_R < 5$ V)
- Optimized for OR-ing applications
- Ultra low forward voltage drop
- High frequency operation
- Guard ring for enhanced ruggedness and long term reliability
- High purity, high temperature epoxy encapsulation for enhanced mechanical strength and moisture resistance
- Compliant to RoHS Directive 2002/95/EC
- Designed and qualified according to JEDEC-JESD47
- Halogen-free according to IEC 61249-2-21 definition (-N3 only)

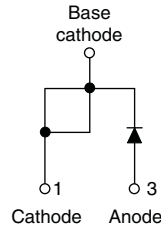

PRODUCT SUMMARY	
Package	TO-220AC
$I_{F(AV)}$	20 A
V_R	15 V
V_F at I_F	See Electrical table
I_{RM} max.	600 mA at 100 °C
T_J max.	125 °C
Diode variation	Single die
E_{AS}	10 mJ

DESCRIPTION

The Schottky rectifier module has been optimized for ultra low forward voltage drop specifically for the OR-ing of parallel power supplies. The proprietary barrier technology allows for reliable operation up to 125 °C junction temperature. Typical applications are in parallel switching power supplies, converters, reverse battery protection, and redundant power subsystems.

MAJOR RATINGS AND CHARACTERISTICS			
SYMBOL	CHARACTERISTICS	VALUES	UNITS
$I_{F(AV)}$	Rectangular waveform	20	A
V_{RRM}		15	V
I_{FSM}	$t_p = 5 \mu s$ sine	700	A
V_F	19 A _{pk} , $T_J = 125$ °C (typical)	0.25	V
T_J	Range	- 55 to 125	°C

VOLTAGE RATINGS				
PARAMETER	SYMBOL	VS-STPS20L15DPbF	VS-STPS20L15D-N3	UNITS
Maximum DC reverse voltage	V_R	15	15	V
Maximum working peak reverse voltage	V_{RWM}			

ABSOLUTE MAXIMUM RATINGS					
PARAMETER	SYMBOL	TEST CONDITIONS		VALUES	UNITS
Maximum average forward current See fig. 5	$I_{F(AV)}$	50 % duty cycle, $T_C = 85$ °C, rectangular waveform		20	A
Maximum peak one cycle non-repetitive surge current See fig. 7	I_{FSM}	5 μs sine or 3 μs rect. pulse	Following any rated load condition and with rated V_{RRM} applied	700	A
		10 ms sine or 6 ms rect. pulse		330	
Non-repetitive avalanche energy	E_{AS}	$T_J = 25$ °C, $I_{AS} = 2$ A, $L = 6$ mH		10	mJ
Repetitive avalanche current	I_{AR}	Current decaying linearly to zero in 1 μs Frequency limited by T_J maximum $V_A = 1.5 \times V_R$ typical		2	A



ELECTRICAL SPECIFICATIONS						
PARAMETER	SYMBOL	TEST CONDITIONS	TYP.	MAX.	UNITS	
Forward voltage drop See fig. 1	$V_{FM}^{(1)}$	19 A	$T_J = 25\text{ }^\circ\text{C}$	-	0.41	V
		40 A		-	0.52	
		19 A	$T_J = 125\text{ }^\circ\text{C}$	0.25	0.33	
		40 A		0.37	0.50	
Reverse leakage current See fig. 2	$I_{RM}^{(1)}$	$T_J = 25\text{ }^\circ\text{C}$	$V_R = \text{Rated } V_R$	-	10	mA
		$T_J = 100\text{ }^\circ\text{C}$		-	600	
Threshold voltage	$V_{F(TO)}$	$T_J = T_J \text{ maximum}$	0.182		V	
Forward slope resistance	r_t		7.6		m Ω	
Maximum junction capacitance	C_T	$V_R = 5 V_{DC}$ (test signal range 100 kHz to 1 MHz) 25 $^\circ\text{C}$	-	2000	pF	
Typical series inductance	L_S	Measured lead to lead 5 mm from package body	8	-	nH	
Maximum voltage rate of change	dV/dt	Rated V_R	10 000		V/ μs	

Note

(1) Pulse width < 300 μs , duty cycle < 2 %

THERMAL - MECHANICAL SPECIFICATIONS				
PARAMETER	SYMBOL	TEST CONDITIONS	VALUES	UNITS
Maximum junction temperature range	T_J		- 55 to 125	$^\circ\text{C}$
Maximum storage temperature range	T_{Stg}		- 55 to 150	
Maximum thermal resistance, junction to case	R_{thJC}	DC operation See fig. 4	1.5	$^\circ\text{C}/\text{W}$
Typical thermal resistance, case to heatsink	R_{thCS}	Mounting surface, smooth and greased (for TO-220)	0.50	
Maximum thermal resistance, junction to ambient	R_{thJA}	DC operation (for D ² PAK)	40	
Approximate weight			2	g
			0.07	oz.
Mounting torque	minimum maximum	Non-lubricated threads	6 (5)	kgf · cm (lbf · in)
			12 (10)	
Marking device		Case style TO-220AC	STPS20L15D	

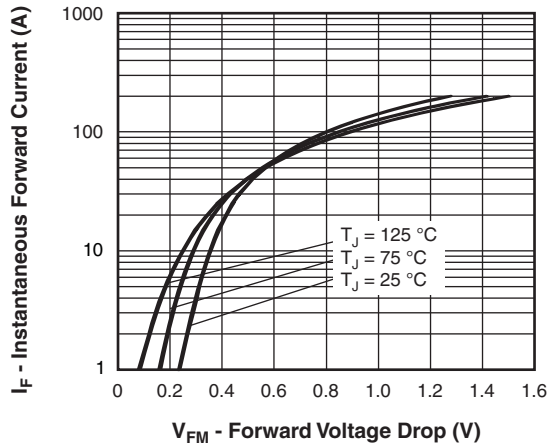

Fig. 1 - Maximum Forward Voltage Drop Characteristics

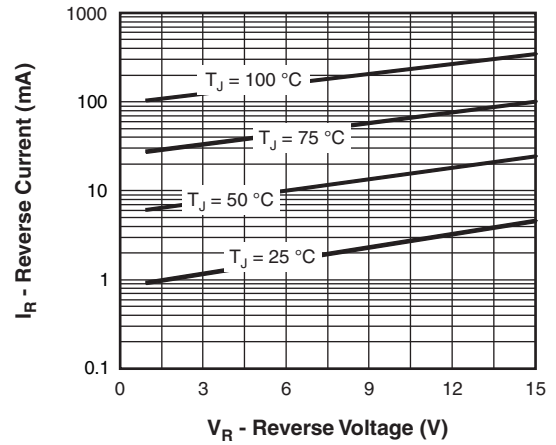

Fig. 2 - Typical Values of Reverse Current vs. Reverse Voltage

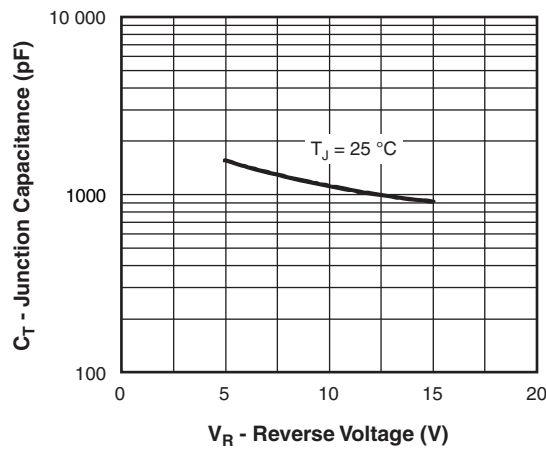

Fig. 3 - Typical Junction Capacitance vs. Reverse Voltage

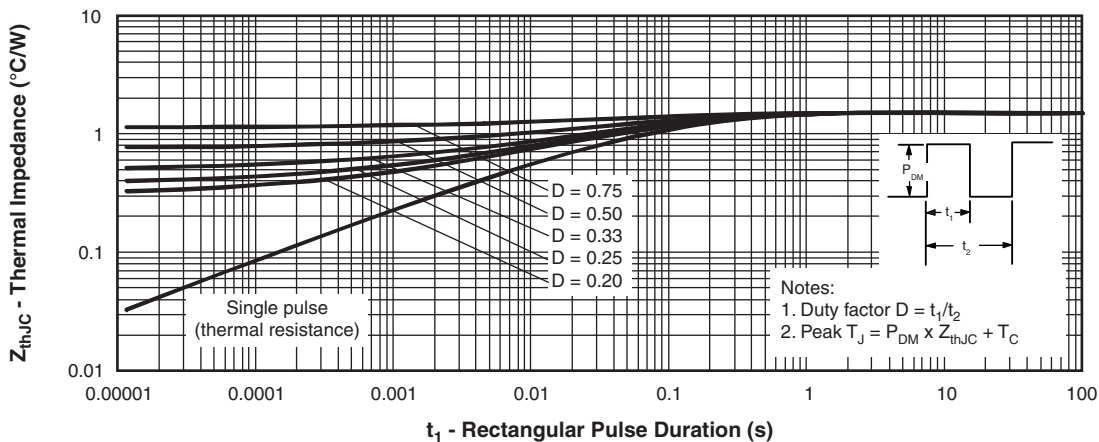

Fig. 4 - Maximum Thermal Impedance Z_{thJC} Characteristics

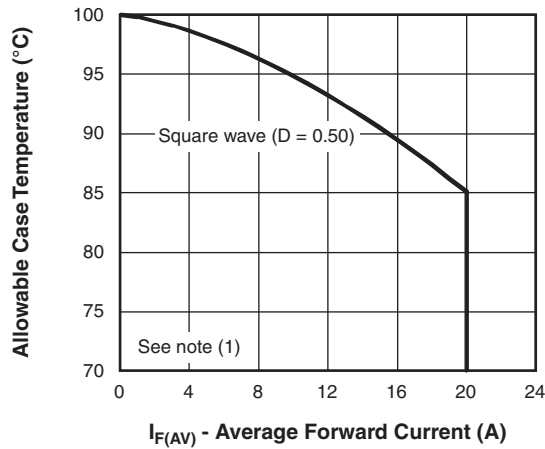

Fig. 5 - Maximum Allowable Case Temperature vs. Average Forward Current

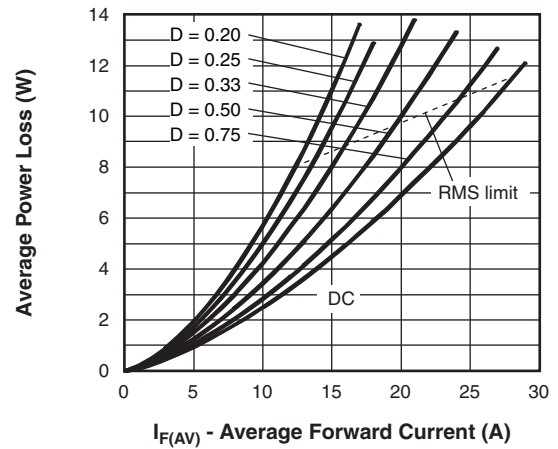

Fig. 6 - Forward Power Loss Characteristics

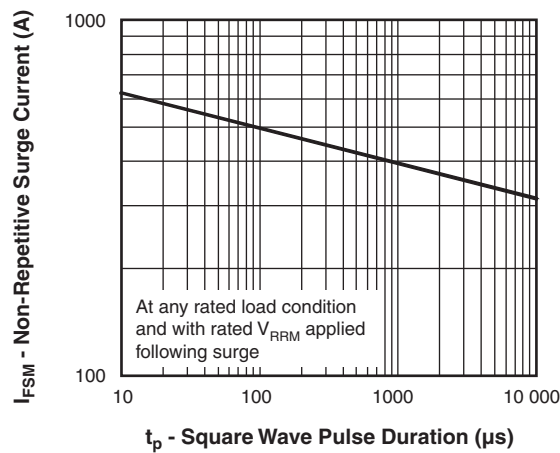

Fig. 7 - Maximum Non-Repetitive Surge Current

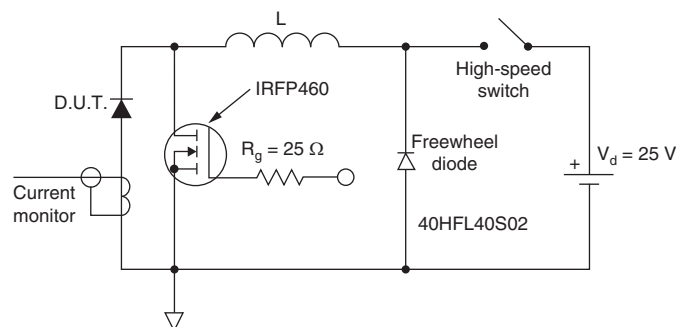

Fig. 8 - Unclamped Inductive Test Circuit

Note

- (1) Formula used: $T_C = T_J - (P_d + P_{d_{REV}}) \times R_{thJC}$;
- P_d = Forward power loss = $I_{F(AV)} \times V_{FM}$ at $(I_{F(AV)}/D)$ (see fig. 6);
- $P_{d_{REV}}$ = Inverse power loss = $V_{R1} \times I_R (1 - D)$; I_R at $V_{R1} = 80\%$ rated V_R



ORDERING INFORMATION TABLE

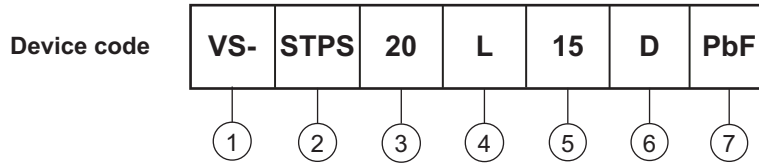

- 1** - Vishay Semiconductors product
- 2** - Schottky STPS series
- 3** - Current rating (20 = 20 A)
- 4** - L = Low voltage drop
- 5** - Voltage rating (15 = 15 V)
- 6** - D = Essential part number
- 7** - Environmental digit
 - PbF = Lead (Pb)-free and RoHS compliant
 - -N3 = Halogen-free, RoHS compliant, and totally lead (Pb)-free

ORDERING INFORMATION (Example)			
PREFERRED P/N	QUANTITY PER T/R	MINIMUM ORDER QUANTITY	PACKAGING DESCRIPTION
VS-STPS20L15DPbF	50	1000	Antistatic plastic tube
VS-STPS20L15D-N3	50	1000	Antistatic plastic tube

LINKS TO RELATED DOCUMENTS	
Dimensions	www.vishay.com/doc?95221
Part marking information	TO-220AC PbF www.vishay.com/doc?95224
	TO-220AC -N3 www.vishay.com/doc?95068
SPIICE model	www.vishay.com/doc?95305

TO-220AC

DIMENSIONS in millimeters and inches

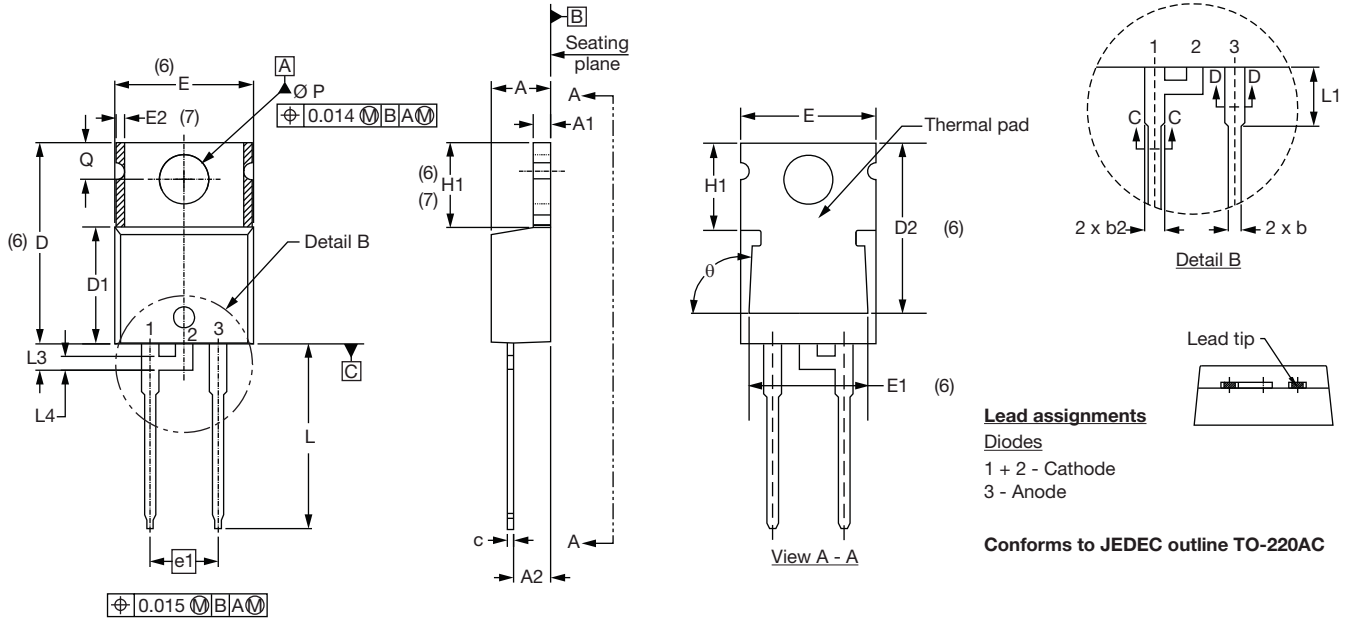

SYMBOL	MILLIMETERS		INCHES		NOTES	SYMBOL	MILLIMETERS		INCHES		NOTES
	MIN.	MAX.	MIN.	MAX.			MIN.	MAX.	MIN.	MAX.	
A	4.25	4.65	0.167	0.183		E1	6.86	8.89	0.270	0.350	6
A1	1.14	1.40	0.045	0.055		E2	-	0.76	-	0.030	7
A2	2.56	2.92	0.101	0.115		e	2.41	2.67	0.095	0.105	
b	0.69	1.01	0.027	0.040		e1	4.88	5.28	0.192	0.208	
b1	0.38	0.97	0.015	0.038	4	H1	6.09	6.48	0.240	0.255	6, 7
b2	1.20	1.73	0.047	0.068		L	13.52	14.02	0.532	0.552	
b3	1.14	1.73	0.045	0.068	4	L1	3.32	3.82	0.131	0.150	2
c	0.36	0.61	0.014	0.024		L3	1.78	2.13	0.070	0.084	
c1	0.36	0.56	0.014	0.022	4	L4	0.76	1.27	0.030	0.050	2
D	14.85	15.25	0.585	0.600	3	Ø P	3.54	3.73	0.139	0.147	
D1	8.38	9.02	0.330	0.355		Q	2.60	3.00	0.102	0.118	
D2	11.68	12.88	0.460	0.507	6	θ	90° to 93°		90° to 93°		
E	10.11	10.51	0.398	0.414	3, 6						

Notes

- (1) Dimensioning and tolerancing as per ASME Y14.5M-1994
- (2) Lead dimension and finish uncontrolled in L1
- (3) Dimension D, D1 and E do not include mold flash. Mold flash shall not exceed 0.127 mm (0.005") per side. These dimensions are measured at the outermost extremes of the plastic body
- (4) Dimension b1, b3 and c1 apply to base metal only
- (5) Controlling dimension: inches
- (6) Thermal pad contour optional within dimensions E, H1, D2 and E1
- (7) Dimension E2 x H1 define a zone where stamping and singulation irregularities are allowed
- (8) Outline conforms to JEDEC TO-220, D2 (minimum) where dimensions are derived from the actual package outline



Disclaimer

ALL PRODUCT, PRODUCT SPECIFICATIONS AND DATA ARE SUBJECT TO CHANGE WITHOUT NOTICE TO IMPROVE RELIABILITY, FUNCTION OR DESIGN OR OTHERWISE.

Vishay Intertechnology, Inc., its affiliates, agents, and employees, and all persons acting on its or their behalf (collectively, "Vishay"), disclaim any and all liability for any errors, inaccuracies or incompleteness contained in any datasheet or in any other disclosure relating to any product.

Vishay makes no warranty, representation or guarantee regarding the suitability of the products for any particular purpose or the continuing production of any product. To the maximum extent permitted by applicable law, Vishay disclaims (i) any and all liability arising out of the application or use of any product, (ii) any and all liability, including without limitation special, consequential or incidental damages, and (iii) any and all implied warranties, including warranties of fitness for particular purpose, non-infringement and merchantability.

Statements regarding the suitability of products for certain types of applications are based on Vishay's knowledge of typical requirements that are often placed on Vishay products in generic applications. Such statements are not binding statements about the suitability of products for a particular application. It is the customer's responsibility to validate that a particular product with the properties described in the product specification is suitable for use in a particular application. Parameters provided in datasheets and / or specifications may vary in different applications and performance may vary over time. All operating parameters, including typical parameters, must be validated for each customer application by the customer's technical experts. Product specifications do not expand or otherwise modify Vishay's terms and conditions of purchase, including but not limited to the warranty expressed therein.

Except as expressly indicated in writing, Vishay products are not designed for use in medical, life-saving, or life-sustaining applications or for any other application in which the failure of the Vishay product could result in personal injury or death. Customers using or selling Vishay products not expressly indicated for use in such applications do so at their own risk. Please contact authorized Vishay personnel to obtain written terms and conditions regarding products designed for such applications.

No license, express or implied, by estoppel or otherwise, to any intellectual property rights is granted by this document or by any conduct of Vishay. Product names and markings noted herein may be trademarks of their respective owners.