

High Efficiency 2-Channel WLED Driver with PWM Control

Features

- High Efficiency (No Switching Losses)
- PWM Frequency as Low as 250 Hz
- Input Voltage Range: 3.0V to 5.5V
- Linear Driver Dropout of 52 mV at 30.2 mA
- Matching Better than $\pm 0.5\%$ (Typical)
- Current Accuracy Better than 1.0% (Typical)
- Available in Thin SOT-23 and SC-70 Packages

Applications

- Mobile Handsets
- Digital Cameras
- Portable Media/MP3 Players
- Portable Navigation Devices (GPS)
- Portable Applications

General Description

The MIC2860-2P is a high efficiency white LED (WLED) driver designed to drive two WLEDs and greatly extend battery life for portable display backlighting and keypad backlighting in low-cost mobile devices. The MIC2860-2P architecture provides the highest possible efficiency by eliminating switching losses present in traditional charge pumps or inductive boost circuits. It features a typical dropout of 52 mV at 30.2 mA per channel. This allows the WLEDs to be driven directly from the battery, eliminating switching noise and losses present with the use of boost circuitry.

The two channels have typical matching of $\leq \pm 0.5\%$, which ensures uniform display illumination under all conditions. The WLED's brightness is externally preset by a resistor and dimmed using PWM interface operating down to less than 1% duty cycle.

The MIC2860-2P is available in Thin SOT-23 and SC-70 6-lead packages with a junction temperature range of -40°C to $+125^{\circ}\text{C}$.

Package Types

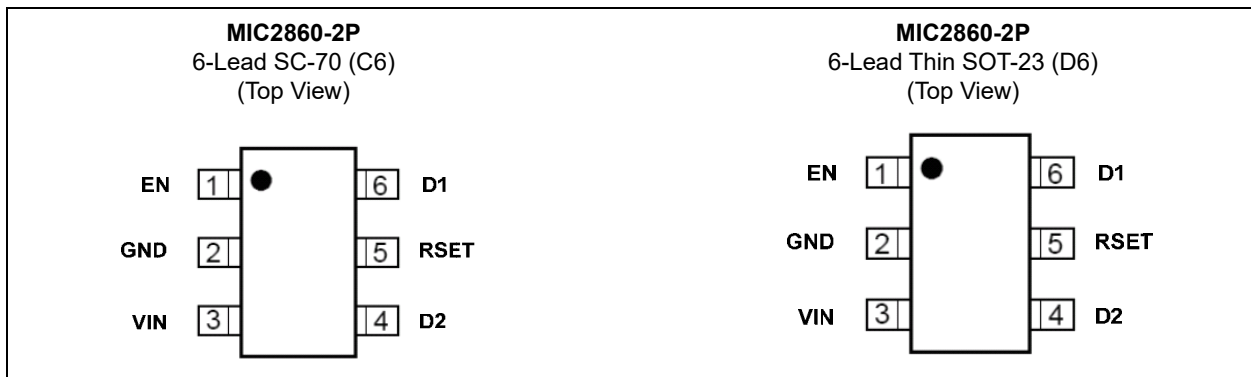

MIC2860-2P

Typical Application Circuit

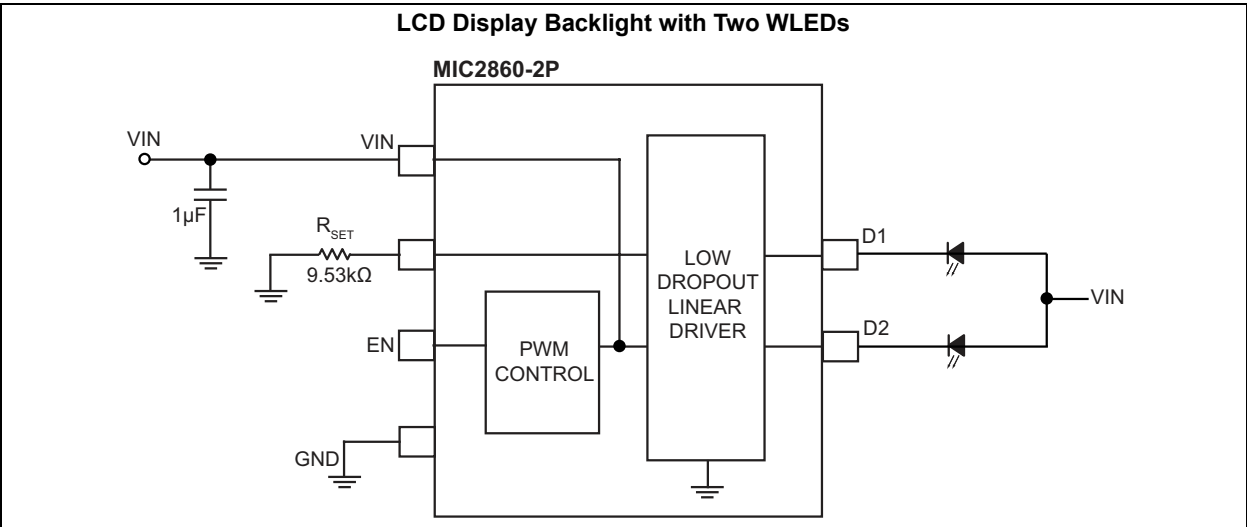

Functional Block Diagram

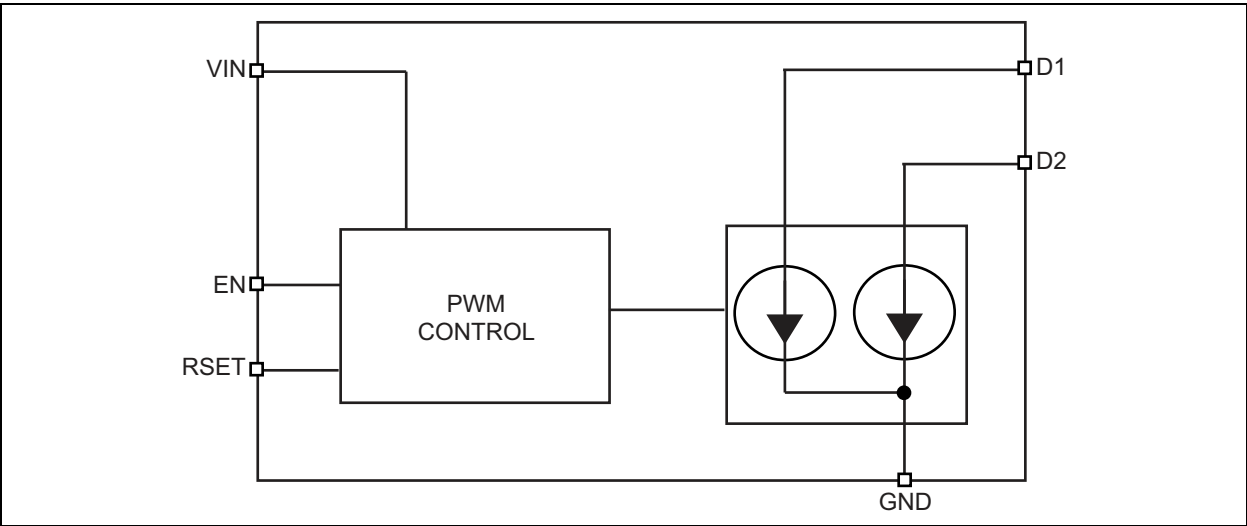

1.0 ELECTRICAL CHARACTERISTICS

Absolute Maximum Ratings †

Main Input Voltage (V_{IN}).....	-0.3V to +6V
Enable Input Voltage (V_{EN}).....	-0.3V to V_{IN}
LED Driver Voltage ($V_{D1, D2}$).....	-0.3V to V_{IN}
Power Dissipation	Internally Limited
ESD Rating	2 kV

Operating Ratings ‡

Supply Voltage (V_{IN})	+3.0 to +5.5V
Enable Input Voltage (V_{EN}).....	.0V to V_{IN}
LED Driver Voltage ($V_{D1, D2}$).....	.0V to V_{IN}

† **Notice:** Stresses above those listed under “Absolute Maximum Ratings” may cause permanent damage to the device. This is a stress rating only and functional operation of the device at those or any other conditions above those indicated in the operational sections of this specification is not intended. Exposure to maximum rating conditions for extended periods may affect device reliability.

‡ **Notice:** The device is not guaranteed to function outside its operating ratings.

ELECTRICAL CHARACTERISTICS

Electrical Characteristics: $V_{IN} = V_{EN} = 3.6V$, $C_{IN} = 1 \mu F$, $R_{SET} = 9.53 k\Omega$; $V_{D1, D2} = 0.6V$; $T_J = +25^\circ C$, **bold** values valid for $-40^\circ C \leq T_J \leq +85^\circ C$; unless noted.

Parameter	Symbol	Min.	Typ.	Max.	Units	Conditions
Current Accuracy		27.18	30.2	33.22	mA	Note 1
Matching		—	± 0.5	± 3	%	Note 2
Dropout ($V_{D1, D2}$)	V_{DROP}	—	52	125	mV	Where $I_{LED} = 90\%$ of LED current seen at $V_{DROPNOM} = 0.6V$, 100% brightness level
Ground/Supply Bias Current	I_{GND}	—	0.7	1.5	mA	$I_{OUT} = 30.2$ mA
Shutdown Current	I_{SHDN}	—	0.01	1	μA	Current source leakage, $V_{EN} = 0V$
PWM Dimming						
Enable Input Voltage	V_{EN}	—	—	0.4	V	Logic low
		1.4	—	—		Logic high
Enable Input Current	I_{EN}	—	0.01	1	μA	$V_{EN} \geq 1.4V$
Current Source Delay (50% Levels)		—	32	80	μs	Shutdown to ON
		—	1.5	4		Standby to ON
		—	0.3	—		ON to Standby
Current Source Transient Time	t_{RISE}	—	0.7	—	μs	10% to 90%
	t_{FALL}	—	0.2	—		
ON-to-Shutdown Time	t_{ON_SD}	4	5.8	10	ms	$V_{EN} = 0V$

Note 1: As determined by the average current of all channels in use and all channels loaded.

2: The current through each LED meets the stated limits from the average current of all LEDs.

MIC2860-2P

TEMPERATURE SPECIFICATIONS

Parameters	Sym.	Min.	Typ.	Max.	Units	Conditions
Temperature Ranges						
Lead Temperature	T_{LEAD}	—	—	+260	°C	Soldering, 10 sec.
Junction Temperature Range	T_J	-40	—	+125	°C	—
Storage Temperature	T_S	-65	—	+150	°C	—
Package Thermal Resistances						
Thermal Resistance, SC-70 6-Ld	θ_{JA}	—	256	—	°C/W	—
Thermal Resistance, TSOT 6-Ld	θ_{JA}	—	177	—	°C/W	—

2.0 TYPICAL PERFORMANCE CURVES

Note: The graphs and tables provided following this note are a statistical summary based on a limited number of samples and are provided for informational purposes only. The performance characteristics listed herein are not tested or guaranteed. In some graphs or tables, the data presented may be outside the specified operating range (e.g., outside specified power supply range) and therefore outside the warranted operating range.

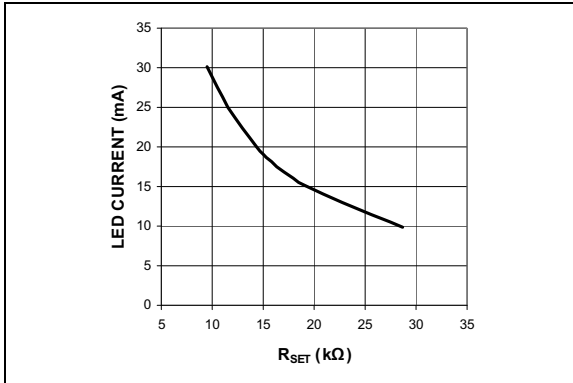

FIGURE 2-1: Peak LED Current vs. R_{SET} .

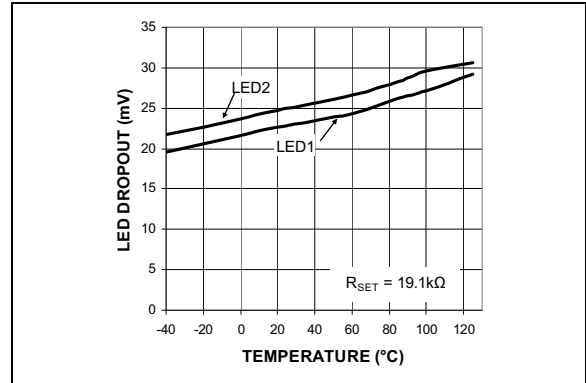

FIGURE 2-4: Dropout Voltage vs. Temperature.

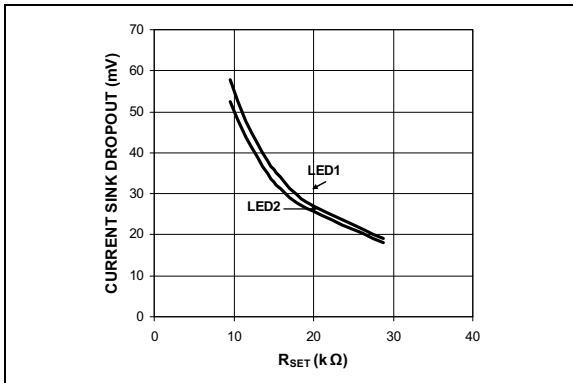

FIGURE 2-2: Dropout Voltage vs. R_{SET} .

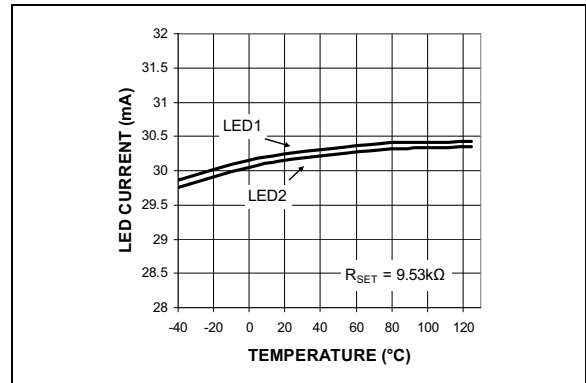

FIGURE 2-5: LED Current vs. Temperature.

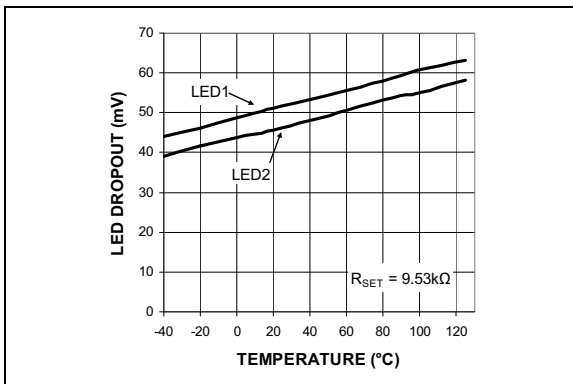

FIGURE 2-3: Dropout Voltage vs. Temperature.

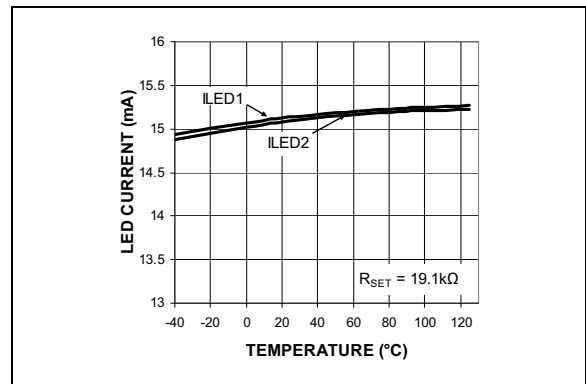

FIGURE 2-6: LED Current vs. Temperature.

MIC2860-2P

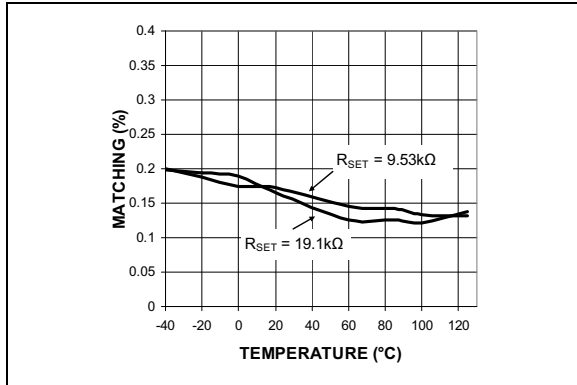

FIGURE 2-7: Matching vs. Temperature.

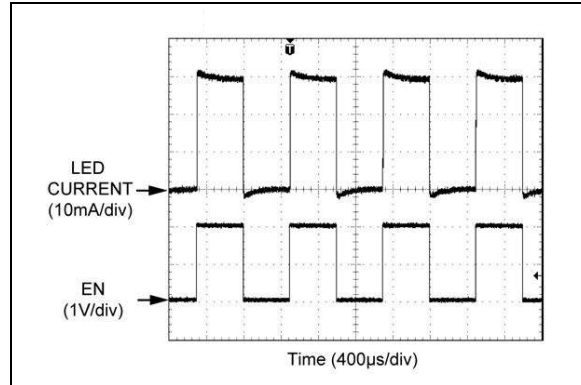

FIGURE 2-10: PWM Signal at 50% Duty Cycle.

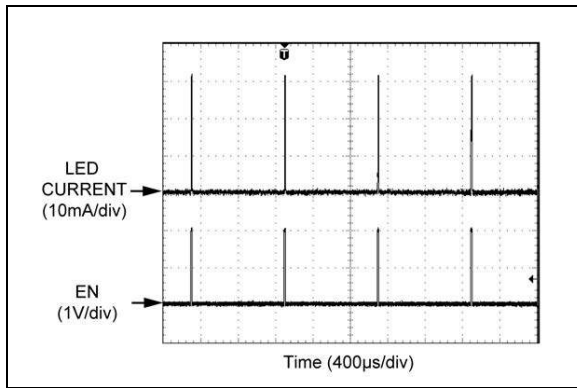

FIGURE 2-8: PWM Signal at 1% Duty Cycle.

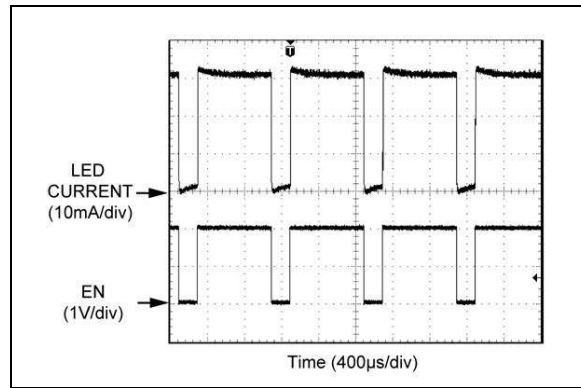

FIGURE 2-11: PWM Signal at 80% Duty Cycle.

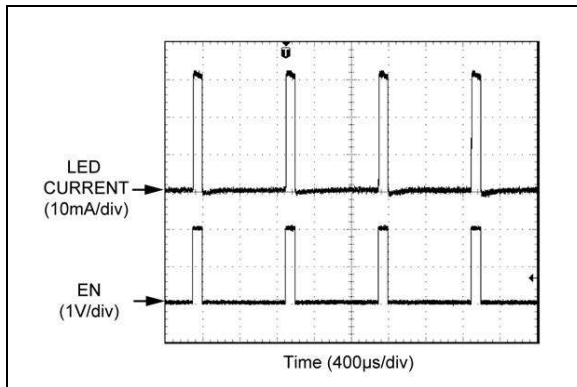

FIGURE 2-9: PWM Signal at 10% Duty Cycle.

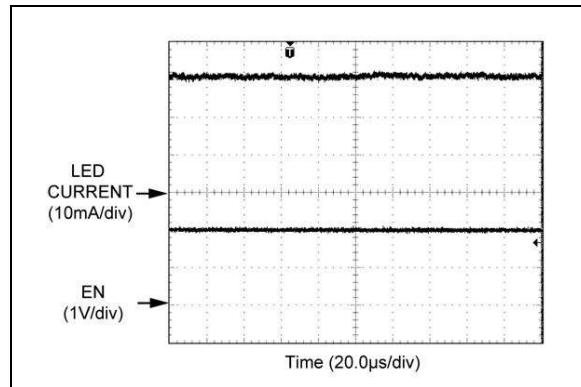

FIGURE 2-12: PWM Signal at 100% Duty Cycle.

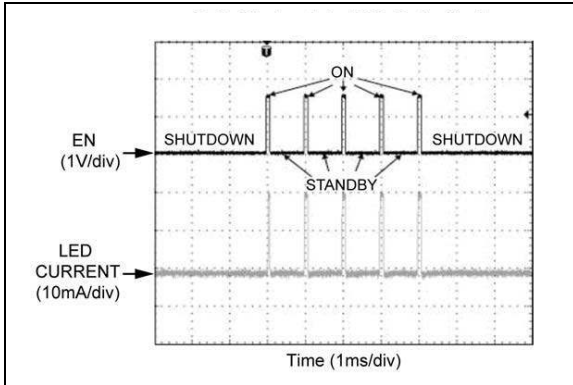

FIGURE 2-13: LED Startup into 10% Duty Cycle.

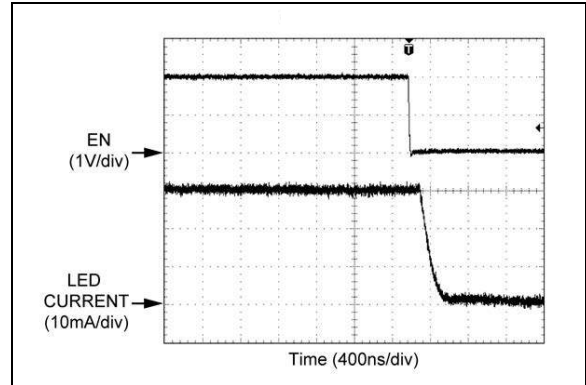

FIGURE 2-16: ON to Standby.

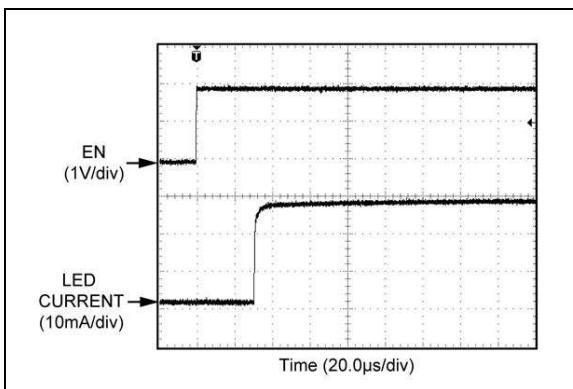

FIGURE 2-14: Shutdown to ON.

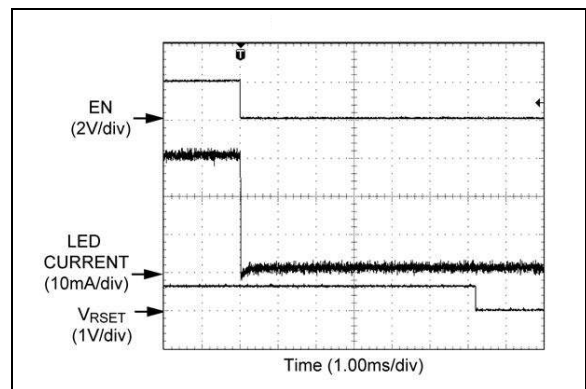

FIGURE 2-17: ON to Shutdown.

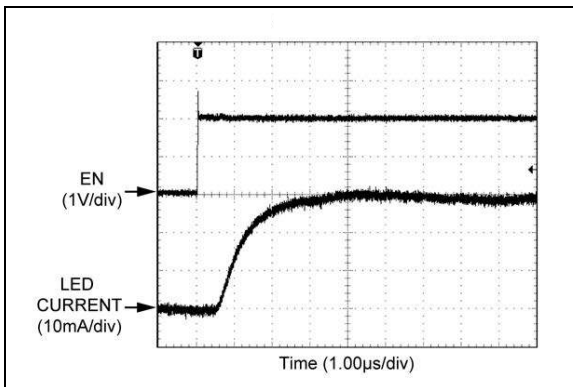

FIGURE 2-15: Standby to ON.

MIC2860-2P

3.0 PIN DESCRIPTIONS

The descriptions of the pins are listed in [Table 3-1](#).

TABLE 3-1: PIN FUNCTION TABLE

Pin Number	Pin Name	Description
1	EN	PWM Control Pin. This pin is used as a PWM input for dimming of WLEDs. Do not leave floating.
2	GND	Ground.
3	VIN	Voltage Input. Connect at least 1 μ F ceramic capacitor between VIN and GND.
4	D2	LED2 driver. Connect LED anode to VIN and cathode to this pin. Do not leave floating.
5	RSET	An internal 1.27V reference sets the nominal maximum WLED current. Example, apply a 9.53 k Ω resistor between RSET and GND to set LED current to 30.2 mA at 100% duty cycle.
6	D1	LED1 driver. Connect LED anode to VIN and cathode to this pin. Do not leave floating.

4.0 FUNCTIONAL DESCRIPTION

The MIC2860-2P is a two channel WLED driver. The WLED driver is designed to maintain proper current regulation with LED current accuracy of 1% with a typical matching between the 2 channels of $\pm 0.5\%$. The WLEDs are driven independently from the input supply and will maintain regulation with a dropout of 52 mV at 30.2 mA. The low dropout of the linear drivers allows the WLEDs to be driven directly from the battery voltage and eliminates the need for large and inefficient charge pumps. The peak WLED current for each channel is set via an external resistor. If dimming is desired the MIC2860-2P can dim via a PWM signal.

4.1 Block Diagram

As shown in the [Functional Block Diagram](#), the MIC2860-2P consists of two current sinks with the peak current determined by R_{SET} . The linear drivers have a designated control block for enabling and dimming of the WLEDs. The MIC2860-2P is controlled by the PWM control block that receives PWM signals for dimming.

4.2 VIN

The input supply (V_{IN}) provides power to the linear drivers and the control circuitry. The V_{IN} operating range is 3V to 5.5V. Due to wire inductance, a minimum bypass capacitor of 1 μF should be placed close to input (V_{IN}) pin and the ground (GND) pin.

4.3 EN

The EN pin enables the linear drivers. It can also be used for dimming with a PWM signal. See the [PWM Dimming Interface](#) section for details. Do not leave floating.

4.4 R_{SET}

The R_{SET} pin is used by connecting a R_{SET} resistor to ground to set the peak current of the linear drivers. The maximum LED current (EN = 100% Duty Cycle) set by the R_{SET} resistor is shown in the table below:

TABLE 4-1: MAX. LED CURRENT VS. R_{SET} RESISTOR VALUES

R_{SET}	I_{LED}
9.53 k Ω	30.2 mA
11.5 k Ω	25.0 mA
14.3 k Ω	20.1 mA
15.8 k Ω	18.2 mA
19.1 k Ω	15.1 mA
28.7 k Ω	10.0 mA

A plot of I_{LED} versus R_{SET} is shown in [Figure 4-1](#).

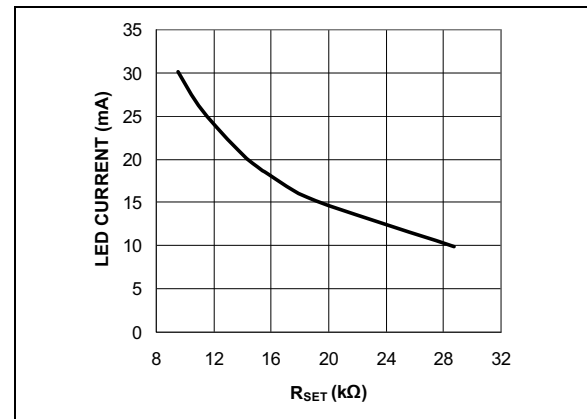

FIGURE 4-1: Peak LED Current vs. R_{SET} .

4.5 D1, D2

The D1 and D2 pins are the linear driver inputs for WLED 1 and 2, respectively. Connect the anodes of the WLEDs to V_{IN} and each cathode of the WLEDs to D1 and D2. When operating with a single WLED, D1 and D2 should be connected to the WLED cathode to parallel the outputs for improved dropout performance. Paralleling these pins can also be done to drive a higher current through a single WLED. Do not leave these pins floating.

4.6 GND

The ground pin is the ground path for the linear drivers. The current loop for the ground should be as small as possible. The ground of the input capacitor should be routed with low impedance traces to the GND pin and made as short as possible.

MIC2860-2P

5.0 APPLICATION INFORMATION

5.1 PWM Dimming Interface

The MIC2860-2P can receive PWM signals from the EN pin for WLED dimming. Dimming is generated by pulsing the WLEDs on and off in synchronization with the PWM signal. The MIC2860-2P incorporates an internal shutdown delay to ensure that the internal control circuitry remains active during PWM dimming for optimum performance.

The lower PWM frequency range is recommended at 250 Hz due to the minimum standby to shutdown time of 4 ms. Because the period of 250 Hz is 4 ms, a 1% duty cycle would have an on time of 40 μ s and an off time of 3.96 ms. To support operation down to 1% duty cycle, the maximum off time must not exceed 4 ms or the drivers may go into the low I_Q shutdown state.

With PWM frequencies higher than 500 Hz the t_{RISE} (0.7 μ s) and t_{FALL} (0.2 μ s) times will have a greater effect on the accuracy of the outputs. An upper frequency of 500 Hz is recommended to maintain output accuracy with duty cycles down to 1%. For systems that do not require a duty cycle below 1%, the frequency of the PWM signal may be increased. For example, with a minimum duty cycle of 10% (3.02 mA with $R_{SET} = 9.53 \text{ k}\Omega$) the PWM frequency can be increased to 10 kHz and still maintain accuracy.

5.2 Input Capacitor

The MIC2860-2P is a high performance, high bandwidth device. Stability can be maintained using a ceramic input capacitor of 1 μ F. Low-ESR ceramic capacitors provide optimal performance with a minimum amount of space. Additional high frequency capacitors, such as small valued NPO dielectric type capacitors, help filter out high-frequency noise and are good practice in any noise-sensitive circuit. X5R or X7R dielectrics are recommended for the input capacitor. Y5V dielectrics lose most of their capacitance over temperature and are therefore, not recommended.

6.0 TYPICAL APPLICATION SCHEMATIC

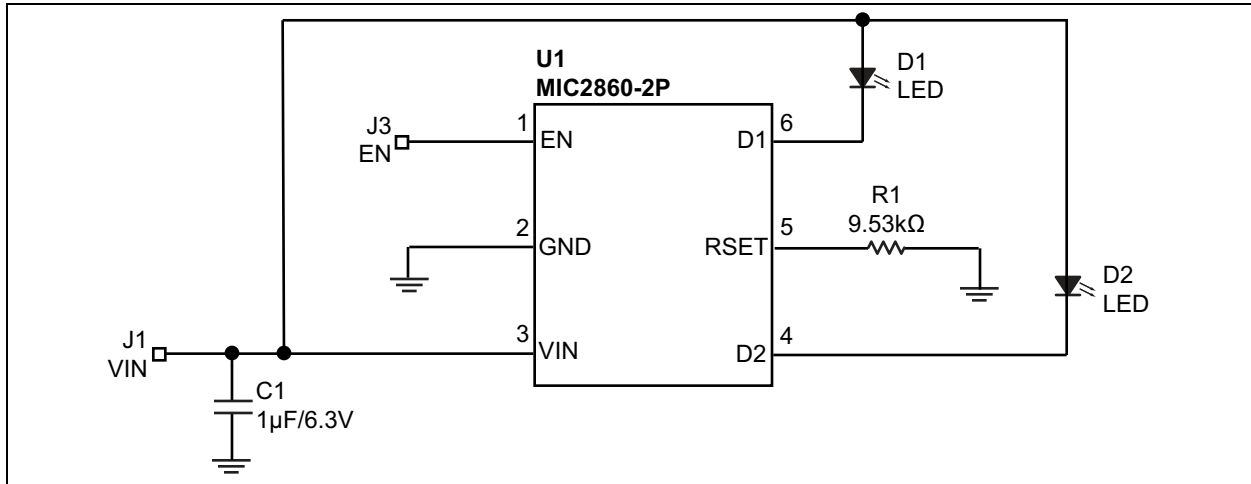





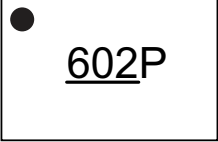

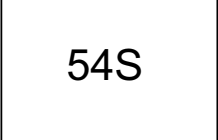

TABLE 6-1: BILL OF MATERIALS

Item	Part Number	Manufacturer	Description	Qty.
C1	C1608X5R0J105K	TDK	1 µF Ceramic Capacitor, 6.3V, X5R, Size 0603	1
R1	CRCW06032052FT1	Vishay	9.53 kΩ, 1%, Size 0603	1
U1	MIC2860-2PYC6	Microchip	2-Channel PWM Linear WLED Driver, SC-70	1
	MIC2860-2PYD6		2-Channel PWM Linear WLED Driver, SOT-23	

MIC2860-2P

7.0 PACKAGING INFORMATION

7.1 Package Marking Information

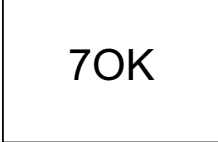
6-Lead SC-70* (Front)	Example	6-Lead TSOT-23* (Front)	Example
			
6-Lead SC-70* (Back)	Example	6-Lead TSOT-23* (Back)	Example
			

Legend:	XX...X	Product code or customer-specific information
	Y	Year code (last digit of calendar year)
	YY	Year code (last 2 digits of calendar year)
	WW	Week code (week of January 1 is week '01')
	NNN	Alphanumeric traceability code
	(e3)	Pb-free JEDEC® designator for Matte Tin (Sn)
	*	This package is Pb-free. The Pb-free JEDEC designator (e3) can be found on the outer packaging for this package.
	●, ▲, ▼	Pin one index is identified by a dot, delta up, or delta down (triangle mark).
Note:	In the event the full Microchip part number cannot be marked on one line, it will be carried over to the next line, thus limiting the number of available characters for customer-specific information. Package may or may not include the corporate logo. Underbar () symbol may not be to scale.	

Note: If the full seven-character YYWWNNN code cannot fit on the package, the following truncated codes are used based on the available marking space:
6 Characters = YWWNNN; 5 Characters = WWNNN; 4 Characters = WNNN; 3 Characters = NNN;
2 Characters = NN; 1 Character = N

6-Lead SC-70 Package Outline and Recommended Land Pattern

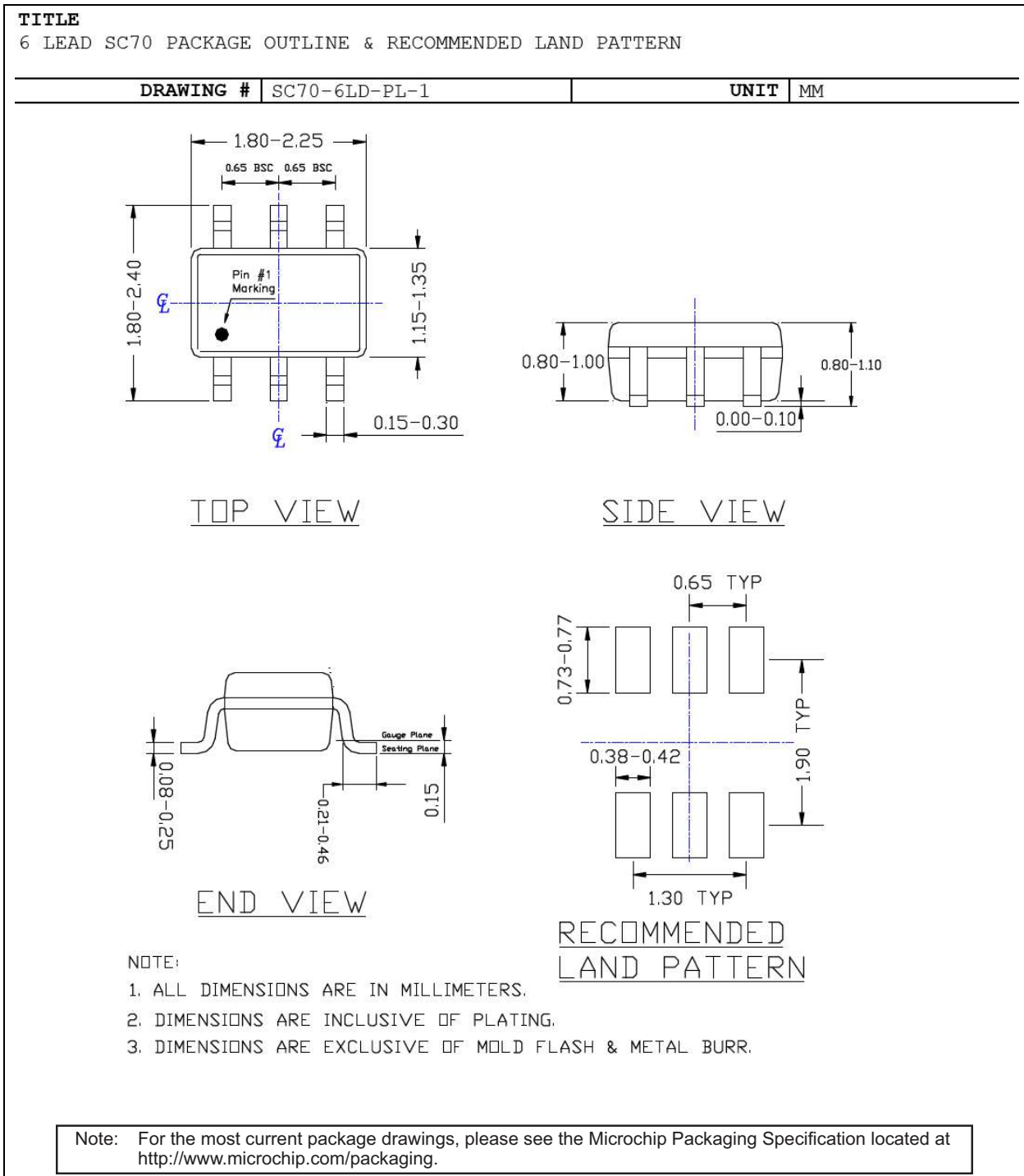

MIC2860-2P

6-Lead Thin SOT-23 Package Outline and Recommended Land Pattern

TITLE

6 LEAD TSOT PACKAGE OUTLINE & RECOMMENDED LAND PATTERN

DRAWING #	TSOT-6LD-PL-1	UNIT	MM
------------------	---------------	-------------	----

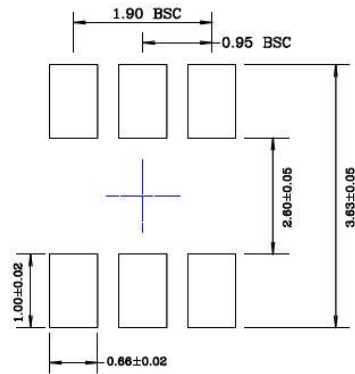
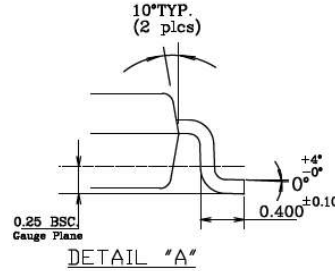
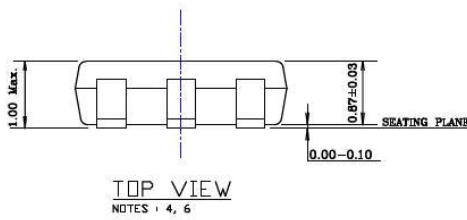
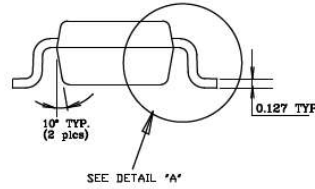
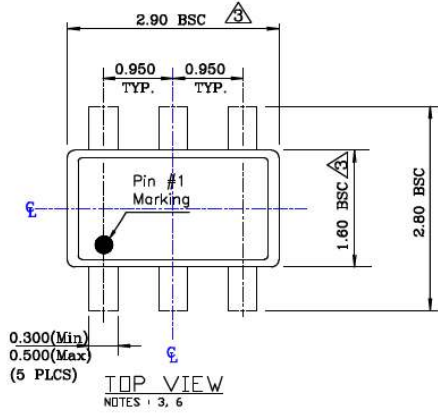

NOTE:

1. Dimensions and tolerances are as per ANSI Y14.5M, 1994.
2. Die is facing up for mold. Die is facing down for trim/form, ie. reverse trim/form.
3. Dimensions are exclusive of mold flash and gate burr.
4. The footlength measuring is based on the gauge plane method.
5. All specification comply to Jedec Spec M0193 Issue C.
6. All dimensions are in millimeters.

Note: For the most current package drawings, please see the Microchip Packaging Specification located at <http://www.microchip.com/packaging>.

APPENDIX A: REVISION HISTORY

Revision A (June 2022)

- Converted Micrel document MIC2860-2P to Microchip data sheet DS20006695A.
- Minor text changes throughout.

MIC2860-2P

NOTES:

PRODUCT IDENTIFICATION SYSTEM

To order or obtain information, e.g., on pricing or delivery, contact your local Microchip representative or sales office.

<u>Part Number</u>	<u>X</u>	<u>XX</u>	<u>-XX</u>	Examples:
Device	Temp. Range	Package	Media Type	
Device:	MIC2860-2P:	High Efficiency 2-Channel WLED Driver with PWM Control		a) MIC2860-2PYC6-TR: MIC2860-2P, -40°C to +125°C Temp. Range, 6-Lead SC-70, 3,000/Reel b) MIC2860-2PYD6-TR: MIC2860-2P, -40°C to +125°C Temp. Range, 6-Lead TSOT-23, 3,000/Reel
Temperature Range:	Y =	-40°C to +125°C		Note 1: Tape and Reel identifier only appears in the catalog part number description. This identifier is used for ordering purposes and is not printed on the device package. Check with your Microchip Sales Office for package availability with the Tape and Reel option.
Package:	C6 = D6 =	6-Lead SC-70 6-Lead Thin SOT-23		
Media Type:	TR =	3,000/Reel		

MIC2860-2P

NOTES:

Note the following details of the code protection feature on Microchip products:

- Microchip products meet the specifications contained in their particular Microchip Data Sheet.
- Microchip believes that its family of products is secure when used in the intended manner, within operating specifications, and under normal conditions.
- Microchip values and aggressively protects its intellectual property rights. Attempts to breach the code protection features of Microchip product is strictly prohibited and may violate the Digital Millennium Copyright Act.
- Neither Microchip nor any other semiconductor manufacturer can guarantee the security of its code. Code protection does not mean that we are guaranteeing the product is "unbreakable" Code protection is constantly evolving. Microchip is committed to continuously improving the code protection features of our products.

This publication and the information herein may be used only with Microchip products, including to design, test, and integrate Microchip products with your application. Use of this information in any other manner violates these terms. Information regarding device applications is provided only for your convenience and may be superseded by updates. It is your responsibility to ensure that your application meets with your specifications. Contact your local Microchip sales office for additional support or, obtain additional support at <https://www.microchip.com/en-us/support/design-help/client-support-services>.

THIS INFORMATION IS PROVIDED BY MICROCHIP "AS IS". MICROCHIP MAKES NO REPRESENTATIONS OR WARRANTIES OF ANY KIND WHETHER EXPRESS OR IMPLIED, WRITTEN OR ORAL, STATUTORY OR OTHERWISE, RELATED TO THE INFORMATION INCLUDING BUT NOT LIMITED TO ANY IMPLIED WARRANTIES OF NON-INFRINGEMENT, MERCHANTABILITY, AND FITNESS FOR A PARTICULAR PURPOSE, OR WARRANTIES RELATED TO ITS CONDITION, QUALITY, OR PERFORMANCE.

IN NO EVENT WILL MICROCHIP BE LIABLE FOR ANY INDIRECT, SPECIAL, PUNITIVE, INCIDENTAL, OR CONSEQUENTIAL LOSS, DAMAGE, COST, OR EXPENSE OF ANY KIND WHATSOEVER RELATED TO THE INFORMATION OR ITS USE, HOWEVER CAUSED, EVEN IF MICROCHIP HAS BEEN ADVISED OF THE POSSIBILITY OR THE DAMAGES ARE FORESEEABLE. TO THE FULLEST EXTENT ALLOWED BY LAW, MICROCHIP'S TOTAL LIABILITY ON ALL CLAIMS IN ANY WAY RELATED TO THE INFORMATION OR ITS USE WILL NOT EXCEED THE AMOUNT OF FEES, IF ANY, THAT YOU HAVE PAID DIRECTLY TO MICROCHIP FOR THE INFORMATION.

Use of Microchip devices in life support and/or safety applications is entirely at the buyer's risk, and the buyer agrees to defend, indemnify and hold harmless Microchip from any and all damages, claims, suits, or expenses resulting from such use. No licenses are conveyed, implicitly or otherwise, under any Microchip intellectual property rights unless otherwise stated.

For information regarding Microchip's Quality Management Systems, please visit www.microchip.com/quality.

Trademarks

The Microchip name and logo, the Microchip logo, Adaptec, AVR, AVR logo, AVR Freaks, BesTime, BitCloud, CryptoMemory, CryptoRF, dsPIC, flexPWR, HELDO, IGL00, JukeBlox, KeeLoq, Klear, LANCheck, LinkMD, maXStylus, maXTouch, MediaLB, megaAVR, Microsemi, Microsemi logo, MOST, MOST logo, MPLAB, OptoLyzer, PIC, picoPower, PICSTART, PIC32 logo, PolarFire, Prochip Designer, QTouch, SAM-BA, SenGenuity, SpyNIC, SST, SST Logo, SuperFlash, Symmetricom, SyncServer, Tachyon, TimeSource, tinyAVR, UNI/O, Vectron, and XMEGA are registered trademarks of Microchip Technology Incorporated in the U.S.A. and other countries.

AgileSwitch, APT, ClockWorks, The Embedded Control Solutions Company, EtherSynch, Flashtec, Hyper Speed Control, HyperLight Load, Libero, motorBench, mTouch, Powermite 3, Precision Edge, ProASIC, ProASIC Plus, ProASIC Plus logo, Quiet-Wire, SmartFusion, SyncWorld, Temux, TimeCesium, TimeHub, TimePictra, TimeProvider, TrueTime, and ZL are registered trademarks of Microchip Technology Incorporated in the U.S.A.

Adjacent Key Suppression, AKS, Analog-for-the-Digital Age, Any Capacitor, AnyIn, AnyOut, Augmented Switching, BlueSky, BodyCom, Clockstudio, CodeGuard, CryptoAuthentication, CryptoAutomotive, CryptoCompanion, CryptoController, dsPICDEM, dsPICDEM.net, Dynamic Average Matching, DAM, ECAN, Espresso T1S, EtherGREEN, GridTime, IdealBridge, In-Circuit Serial Programming, ICSP, INICnet, Intelligent Paralleling, IntelliMOS, Inter-Chip Connectivity, JitterBlocker, Knob-on-Display, KoD, maxCrypto, maxView, memBrain, Mindi, MiWi, MPASM, MPF, MPLAB Certified logo, MPLIB, MPLINK, MultiTRAK, NetDetach, Omniscient Code Generation, PICDEM, PICDEM.net, PICkit, PICtail, PowerSmart, PureSilicon, QMatrix, REAL ICE, Ripple Blocker, RTAX, RTG4, SAM-ICE, Serial Quad I/O, simpleMAP, SimpliPHY, SmartBuffer, SmartHLS, SMART-I.S., storClad, SQI, SuperSwitcher, SuperSwitcher II, Switchtec, SynchroPHY, Total Endurance, Trusted Time, TSHARC, USBCheck, VariSense, VectorBlox, VeriPHY, ViewSpan, WiperLock, XpressConnect, and ZENA are trademarks of Microchip Technology Incorporated in the U.S.A. and other countries.

SQTP is a service mark of Microchip Technology Incorporated in the U.S.A.

The Adaptec logo, Frequency on Demand, Silicon Storage Technology, and Symmcom are registered trademarks of Microchip Technology Inc. in other countries.

GestIC is a registered trademark of Microchip Technology Germany II GmbH & Co. KG, a subsidiary of Microchip Technology Inc., in other countries.

All other trademarks mentioned herein are property of their respective companies.

© 2022, Microchip Technology Incorporated and its subsidiaries.

All Rights Reserved.

ISBN: 978-1-6683-0622-2



MICROCHIP

Worldwide Sales and Service

AMERICAS

Corporate Office
2355 West Chandler Blvd.
Chandler, AZ 85224-6199
Tel: 480-792-7200
Fax: 480-792-7277
Technical Support:
<http://www.microchip.com/support>
Web Address:
www.microchip.com

Atlanta
Duluth, GA
Tel: 678-957-9614
Fax: 678-957-1455

Austin, TX
Tel: 512-257-3370

Boston
Westborough, MA
Tel: 774-760-0087
Fax: 774-760-0088

Chicago
Itasca, IL
Tel: 630-285-0071
Fax: 630-285-0075

Dallas
Addison, TX
Tel: 972-818-7423
Fax: 972-818-2924

Detroit
Novi, MI
Tel: 248-848-4000

Houston, TX
Tel: 281-894-5983

Indianapolis
Noblesville, IN
Tel: 317-773-8323
Fax: 317-773-5453
Tel: 317-536-2380

Los Angeles
Mission Viejo, CA
Tel: 949-462-9523
Fax: 949-462-9608
Tel: 951-273-7800

Raleigh, NC
Tel: 919-844-7510

New York, NY
Tel: 631-435-6000

San Jose, CA
Tel: 408-735-9110
Tel: 408-436-4270

Canada - Toronto
Tel: 905-695-1980
Fax: 905-695-2078

ASIA/PACIFIC

Australia - Sydney
Tel: 61-2-9868-6733

China - Beijing
Tel: 86-10-8569-7000

China - Chengdu
Tel: 86-28-8665-5511

China - Chongqing
Tel: 86-23-8980-9588

China - Dongguan
Tel: 86-769-8702-9880

China - Guangzhou
Tel: 86-20-8755-8029

China - Hangzhou
Tel: 86-571-8792-8115

China - Hong Kong SAR
Tel: 852-2943-5100

China - Nanjing
Tel: 86-25-8473-2460

China - Qingdao
Tel: 86-532-8502-7355

China - Shanghai
Tel: 86-21-3326-8000

China - Shenyang
Tel: 86-24-2334-2829

China - Shenzhen
Tel: 86-755-8864-2200

China - Suzhou
Tel: 86-186-6233-1526

China - Wuhan
Tel: 86-27-5980-5300

China - Xian
Tel: 86-29-8833-7252

China - Xiamen
Tel: 86-592-2388138

China - Zhuhai
Tel: 86-756-3210040

ASIA/PACIFIC

India - Bangalore
Tel: 91-80-3090-4444

India - New Delhi
Tel: 91-11-4160-8631

India - Pune
Tel: 91-20-4121-0141

Japan - Osaka
Tel: 81-6-6152-7160

Japan - Tokyo
Tel: 81-3-6880-3770

Korea - Daegu
Tel: 82-53-744-4301

Korea - Seoul
Tel: 82-2-554-7200

Malaysia - Kuala Lumpur
Tel: 60-3-7651-7906

Malaysia - Penang
Tel: 60-4-227-8870

Philippines - Manila
Tel: 63-2-634-9065

Singapore
Tel: 65-6334-8870

Taiwan - Hsin Chu
Tel: 886-3-577-8366

Taiwan - Kaohsiung
Tel: 886-7-213-7830

Taiwan - Taipei
Tel: 886-2-2508-8600

Thailand - Bangkok
Tel: 66-2-694-1351

Vietnam - Ho Chi Minh
Tel: 84-28-5448-2100

EUROPE

Austria - Wels
Tel: 43-7242-2244-39
Fax: 43-7242-2244-393

Denmark - Copenhagen
Tel: 45-4485-5910
Fax: 45-4485-2829

Finland - Espoo
Tel: 358-9-4520-820

France - Paris
Tel: 33-1-69-53-63-20
Fax: 33-1-69-30-90-79

Germany - Garching
Tel: 49-8931-9700

Germany - Haan
Tel: 49-2129-3766400

Germany - Heilbronn
Tel: 49-7131-72400

Germany - Karlsruhe
Tel: 49-721-625370

Germany - Munich
Tel: 49-89-627-144-0
Fax: 49-89-627-144-44

Germany - Rosenheim
Tel: 49-8031-354-560

Israel - Ra'anana
Tel: 972-9-744-7705

Italy - Milan
Tel: 39-0331-742611
Fax: 39-0331-466781

Italy - Padova
Tel: 39-049-7625286

Netherlands - Drunen
Tel: 31-416-690399
Fax: 31-416-690340

Norway - Trondheim
Tel: 47-7288-4388

Poland - Warsaw
Tel: 48-22-3325737

Romania - Bucharest
Tel: 40-21-407-87-50

Spain - Madrid
Tel: 34-91-708-08-90
Fax: 34-91-708-08-91

Sweden - Gothenberg
Tel: 46-31-704-60-40

Sweden - Stockholm
Tel: 46-8-5090-4654

UK - Wokingham
Tel: 44-118-921-5800
Fax: 44-118-921-5820