



Ultra-Low Offset/Drift, Low-Noise, Precision SOT23 Amplifiers

MAX4238/MAX4239

General Description

The MAX4238/MAX4239 are low-noise, low-drift, ultra-high precision amplifiers that offer near-zero DC offset and drift through the use of patented autocorrelating zeroing techniques. This method constantly measures and compensates the input offset, eliminating drift over time and temperature and the effect of $1/f$ noise. Both devices feature rail-to-rail outputs, operate from a single 2.7V to 5.5V supply, and consume only 600 μ A. An active-low shutdown mode decreases supply current to 0.1 μ A.

The MAX4238 is unity-gain stable with a gain-bandwidth product of 1MHz, while the decompensated MAX4239 is stable with $A_v \geq 10V/V$ and a GBWP of 6.5MHz. The MAX4238/MAX4239 are available in 8-pin narrow SO, 6-pin TDFN and SOT23 packages.

Applications

Thermocouples
Strain Gauges
Electronic Scales
Medical Instrumentation
Instrumentation Amplifiers

Typical Application Circuit

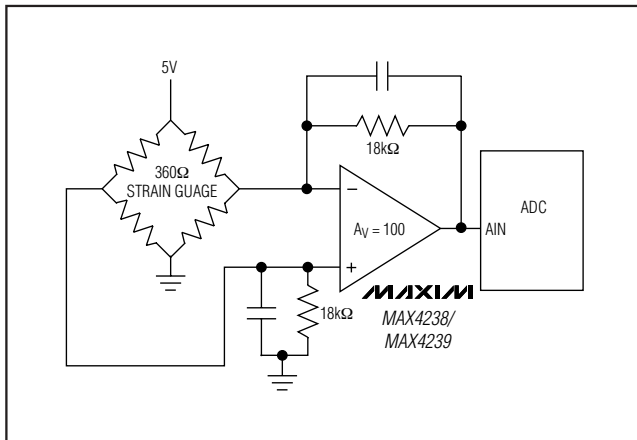

Features

- ◆ Ultra-Low, 0.1 μ V Offset Voltage
 - 2.0 μ V (max) at +25°C
 - 2.5 μ V (max) at -40°C to +85°C
 - 3.5 μ V (max) at -40°C to +125°C
- ◆ Low 10nV/°C Drift
- ◆ Specified over the -40°C to +125°C Automotive Temperature Range
- ◆ Low Noise: 1.5 μ Vp.p from DC to 10Hz
- ◆ 150dB A_{VOL} , 140dB PSRR, 140dB CMRR
- ◆ High Gain-Bandwidth Product
 - 1MHz (MAX4238)
 - 6.5MHz (MAX4239)
- ◆ 0.1 μ A Shutdown Mode
- ◆ Rail-to-Rail Output ($R_L = 1k\Omega$)
- ◆ Low 600 μ A Supply Current
- ◆ Ground-Sensing Input
- ◆ Single 2.7V to 5.5V Supply Voltage Range
- ◆ Available in a Space-Saving 6-Pin SOT23 and TDFN Packages

Ordering Information

PART	PIN-PACKAGE	TOP MARK	PKG CODE
MAX4238AUT-T	6 SOT23-6	AAZZ	U6F-6
MAX4238ASA	8 SO	—	S8-4
MAX4238ATT+T	6 TDFN-EP*	+ANG	T633-2
MAX4239AUT-T	6 SOT23-6	ABAA	U6F-6
MAX4239ASA	8 SO	—	S8-4
MAX4239ATT+T	6 TDFN-EP*	+ANH	T633-2

Note: All devices are specified over the -40°C to +125°C operating temperature range.

+Denotes lead-free package.

*EP = Exposed paddle.

Selector Guide

PART	MINIMUM STABLE GAIN	GAIN BANDWIDTH (MHz)
MAX4238	1V/V	1
MAX4239	10V/V	6.5

Pin Configurations appear at end of data sheet.



Ultra-Low Offset/Drift, Low-Noise, Precision SOT23 Amplifiers

ABSOLUTE MAXIMUM RATINGS

Power-Supply Voltage (V_{CC} to GND).....6V
 All Other Pins(GND - 0.3V) to (V_{CC} + 0.3V)
 Output Short-Circuit Duration
 (OUT shorted to V_{CC} or GND)Continuous
 Continuous Power Dissipation ($T_A = +70^\circ\text{C}$)
 6-Pin Plastic SOT23
 (derate 9.1mW/ $^\circ\text{C}$ above $+70^\circ\text{C}$)727mW

8-Pin Plastic SO (derate 5.88mW/ $^\circ\text{C}$ above $+70^\circ\text{C}$).....471mW
 6-Pin TDFN-EP (derate 18.2mW above $+70^\circ\text{C}$).....1454mW
 Operating Temperature Range -40°C to $+125^\circ\text{C}$
 Junction Temperature $+150^\circ\text{C}$
 Storage Temperature Range..... -65°C to $+150^\circ\text{C}$
 Lead Temperature (soldering, 10s) $+300^\circ\text{C}$

Stresses beyond those listed under "Absolute Maximum Ratings" may cause permanent damage to the device. These are stress ratings only, and functional operation of the device at these or any other conditions beyond those indicated in the operational sections of the specifications is not implied. Exposure to absolute maximum rating conditions for extended periods may affect device reliability.

ELECTRICAL CHARACTERISTICS

($2.7\text{V} \leq V_{CC} \leq 5.5\text{V}$, $V_{CM} = \text{GND} = 0\text{V}$, $V_{OUT} = V_{CC}/2$, $R_L = 10\text{k}\Omega$ connected to $V_{CC}/2$, $\overline{\text{SHDN}} = V_{CC}$, $T_A = +25^\circ\text{C}$, unless otherwise noted.)

PARAMETER	SYMBOL	CONDITIONS	MIN	TYP	MAX	UNITS
Input Offset Voltage	V_{OS}	(Note 1)		0.1	2	μV
Long-Term Offset Drift				50		nV/1000hr
Input Bias Current	I_B	(Note 2)		1		pA
Input Offset Current	I_{OS}	(Note 2)		2		pA
Peak-to-Peak Input Noise Voltage	$e_{n\text{P-P}}$	$R_S = 100\Omega$, 0.01Hz to 10Hz		1.5		$\mu\text{V}_{\text{P-P}}$
Input Voltage-Noise Density	e_n	$f = 1\text{kHz}$		30		NV/ $\sqrt{\text{Hz}}$
Common-Mode Input Voltage Range	V_{CM}	Inferred from CMRR test	GND - 0.1		V_{CC} - 1.3	V
Common-Mode Rejection Ratio	CMRR	$-0.1\text{V} \leq V_{CM} \leq V_{CC} - 1.3\text{V}$ (Note 1)	120	140		dB
Power-Supply Rejection Ratio	PSRR	$2.7\text{V} \leq V_{CC} \leq 5.5\text{V}$ (Note 1)	120	140		dB
Large-Signal Voltage Gain	A_{VOL}	$0.05\text{V} \leq V_{OUT} \leq V_{CC} - 0.05\text{V}$ (Note 1)	$R_L = 10\text{k}\Omega$	125	150	dB
		$0.1\text{V} \leq V_{OUT} \leq V_{CC} - 0.1\text{V}$ (Note 1)	$R_L = 1\text{k}\Omega$	125	145	
Output Voltage Swing	V_{OH}/V_{OL}	$R_L = 10\text{k}\Omega$	$V_{CC} - V_{OH}$	4	10	mV
			V_{OL}	4	10	
		$R_L = 1\text{k}\Omega$	$V_{CC} - V_{OH}$	35	50	
			V_{OL}	35	50	
Output Short-Circuit Current		To either supply		40		mA
Output Leakage Current		$0 \leq V_{OUT} \leq V_{CC}$, $\overline{\text{SHDN}} = \text{GND}$ (Note 2)		0.01	1	μA
Slew Rate		$V_{CC} = 5\text{V}$, $C_L = 100\text{pF}$, $V_{OUT} = 2\text{V}$ step	MAX4238	0.35		V/ μs
			MAX4239	1.6		
Gain-Bandwidth Product	GBWP	$R_L = 10\text{k}\Omega$, $C_L = 100\text{pF}$, measured at $f = 100\text{kHz}$	MAX4238	1		MHz
			MAX4239	6.5		
Minimum Stable Closed-Loop Gain		$R_L = 10\text{k}\Omega$, $C_L = 100\text{pF}$, phase margin = 60°	MAX4238	1		V/V
			MAX4239	10		

Ultra-Low Offset/Drift, Low-Noise, Precision SOT23 Amplifiers

MAX4238/MAX4239

ELECTRICAL CHARACTERISTICS (continued)

($2.7V \leq V_{CC} \leq 5.5V$, $V_{CM} = GND = 0V$, $V_{OUT} = V_{CC}/2$, $R_L = 10k\Omega$ connected to $V_{CC}/2$, $\overline{SHDN} = V_{CC}$, $T_A = +25^\circ C$, unless otherwise noted.)

PARAMETER	SYMBOL	CONDITIONS	MIN	TYP	MAX	UNITS
Maximum Closed-Loop Gain		$R_L = 10k\Omega$, $C_L = 100pF$, phase margin = 60°	MAX4238	1000		V/V
			MAX4239	6700		
Settling Time		-1V step	0.1% (10 bit)	0.5		ms
			0.025% (12 bit)	1.0		
			0.006% (14 bit)	1.7		
			0.0015% (16 bit)	2.3		
Overload Recovery Time		$A_V = 10$ (Note 4)	0.1% (10 bit)	3.3		ms
			0.025% (12 bit)	4.1		
			0.006% (14 bit)	4.9		
			0.0015% (16 bit)	5.7		
Startup Time		$A_V = 10$	0.1% (10 bit)	1.8		ms
			0.025% (12 bit)	2.6		
			0.006% (14 bit)	3.4		
			0.0015% (16 bit)	4.3		
Supply Voltage Range	V_{CC}	Inferred by PSRR test	2.7		5.5	V
Supply Current	I_{CC}	$\overline{SHDN} = V_{CC}$, no load, $V_{CC} = 5.5V$		600	850	μA
		$\overline{SHDN} = GND$, $V_{CC} = 5.5V$		0.1	1	
Shutdown Logic-High	V_{IH}		2.2			V
Shutdown Logic-Low	V_{IL}				0.8	V
Shutdown Input Current		$0V \leq V_{\overline{SHDN}} \leq V_{CC}$		0.1	1	μA

Ultra-Low Offset/Drift, Low-Noise, Precision SOT23 Amplifiers

ELECTRICAL CHARACTERISTICS

($2.7V \leq V_{CC} \leq 5.5V$, $V_{CM} = GND = 0V$, $V_{OUT} = V_{CC}/2$, $R_L = 10k\Omega$ connected to $V_{CC}/2$, $\overline{SHDN} = V_{CC}$, $T_A = -40^\circ\text{C}$ to $+125^\circ\text{C}$, unless otherwise noted.) (Note 5)

PARAMETER	SYMBOL	CONDITIONS		MIN	TYP	MAX	UNITS
Input Offset Voltage	V_{OS}	(Note 1)	$T_A = -40^\circ\text{C}$ to $+85^\circ\text{C}$			2.5	μV
			$T_A = -40^\circ\text{C}$ to $+125^\circ\text{C}$			3.5	
Input Offset Drift	TCV_{OS}	(Note 1)			10		$\text{nV}/^\circ\text{C}$
Common-Mode Input Voltage Range	V_{CM}	Inferred from CMRR test		GND - 0.05		V_{CC} - 1.4	V
Common-Mode Rejection Ratio	CMRR	$GND - 0.05V \leq V_{CM} \leq V_{CC} - 1.4V$ (Note 1)	$T_A = -40^\circ\text{C}$ to $+85^\circ\text{C}$	115			dB
			$T_A = -40^\circ\text{C}$ to $+125^\circ\text{C}$	90			
Power-Supply Rejection Ratio	PSRR	$2.7V \leq V_{CC} \leq 5.5V$ (Note 1)		120			dB
Large-Signal Voltage Gain	A_{VOL}	$R_L = 10k\Omega$, $0.1V \leq V_{OUT} \leq V_{CC} - 0.1V$ (Note 1)	$T_A = -40^\circ\text{C}$ to $+85^\circ\text{C}$	125			dB
			$T_A = -40^\circ\text{C}$ to $+125^\circ\text{C}$	95			
		$R_L = 1k\Omega$ (Note 1)	$0.1V \leq V_{OUT} \leq V_{CC} - 0.1V$, $T_A = -40^\circ\text{C}$ to $+85^\circ\text{C}$	120			dB
			$0.2V \leq V_{OUT} \leq V_{CC} - 0.2V$, $T_A = -40^\circ\text{C}$ to $+125^\circ\text{C}$	80			
Output Voltage Swing	V_{OH}/V_{OL}	$R_L = 10k\Omega$	$V_{CC} - V_{OH}$			20	mV
			V_{OL}			20	
		$R_L = 1k\Omega$	$V_{CC} - V_{OH}$			100	
			V_{OL}			100	
Output Leakage Current		$0V \leq V_{OUT} \leq V_{CC}$, $\overline{SHDN} = GND$ (Note 3)				2	μA
Supply Voltage Range	V_{CC}	Inferred by PSRR test		2.7		5.5	V
Supply Current	I_{CC}	$\overline{SHDN} = V_{CC}$, no load, $V_{CC} = 5.5V$				900	μA
		$\overline{SHDN} = GND$, $V_{CC} = 5.5V$				2	
Shutdown Logic High	V_{IH}			2.2			V
Shutdown Logic Low	V_{IL}					0.7	V
Shutdown Input Current		$0V \leq V_{\overline{SHDN}} \leq V_{CC}$				2	μA

Note 1: Guaranteed by design. Thermocouple and leakage effects preclude measurement of this parameter during production testing. Devices are screened during production testing to eliminate defective units.

Note 2: $IN+$ and $IN-$ are gates to CMOS transistors with typical input bias current of 1pA. CMOS leakage is so small that it is impractical to test and guarantee in production. Devices are screened during production testing to eliminate defective units.

Note 3: Leakage does not include leakage through feedback resistors.

Note 4: Overload recovery time is the time required for the device to recover from saturation when the output has been driven to either rail.

Note 5: Specifications are 100% tested at $T_A = +25^\circ\text{C}$, unless otherwise noted. Limits over temperature are guaranteed by design.

Ultra-Low Offset/Drift, Low-Noise, Precision SOT23 Amplifiers

Typical Operating Characteristics

($V_{CC} = 5V$, $V_{CM} = 0V$, $R_L = 10k\Omega$ connected to $V_{CC}/2$, $\overline{SHDN} = V_{CC}$, $T_A = +25^\circ C$, unless otherwise noted.)

MAX4238/MAX4239

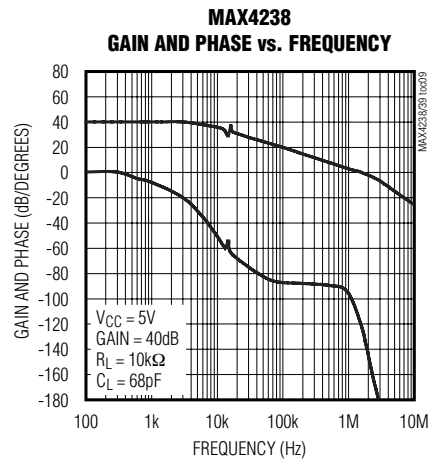
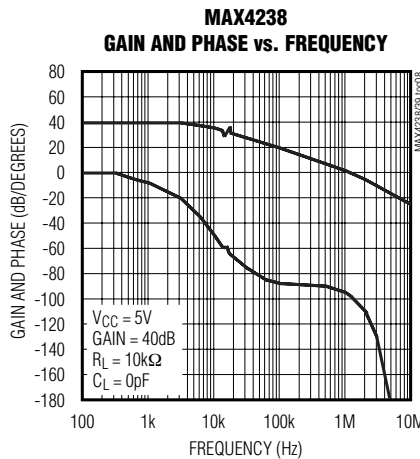
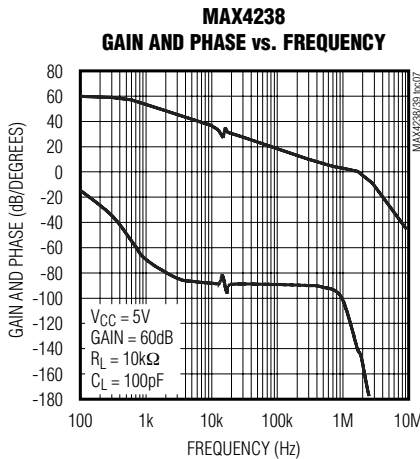
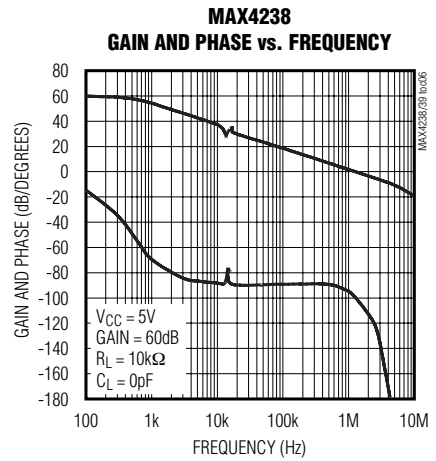
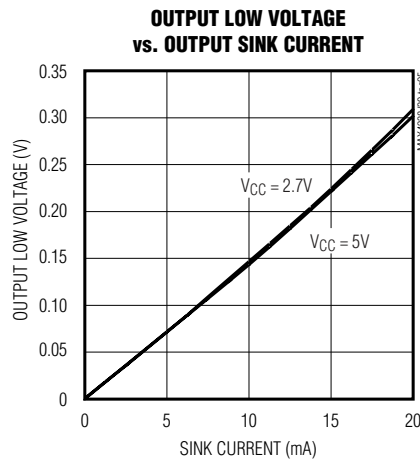
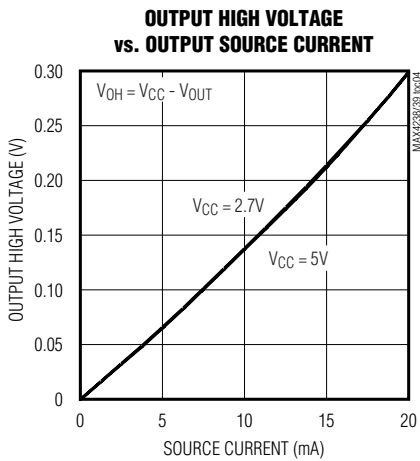
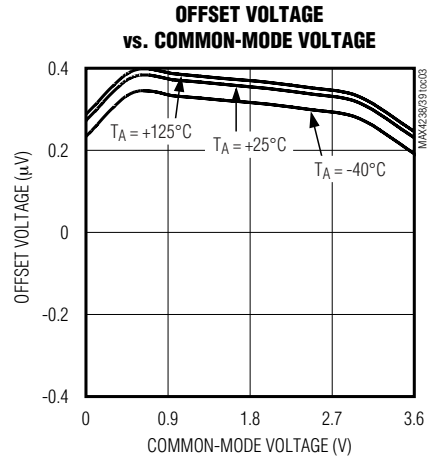
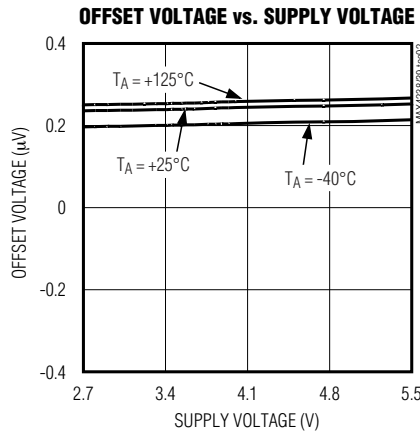
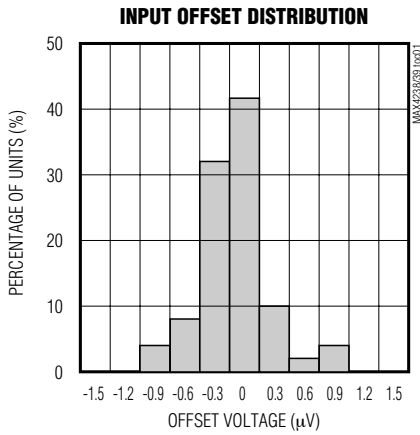

Ultra-Low Offset/Drift, Low-Noise, Precision SOT23 Amplifiers

Typical Operating Characteristics (continued)

($V_{CC} = 5V$, $V_{CM} = 0V$, $R_L = 10k\Omega$ connected to $V_{CC}/2$, $\overline{SHDN} = V_{CC}$, $T_A = +25^\circ C$, unless otherwise noted.)

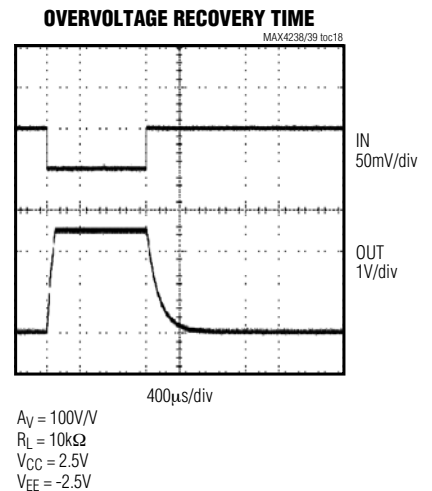
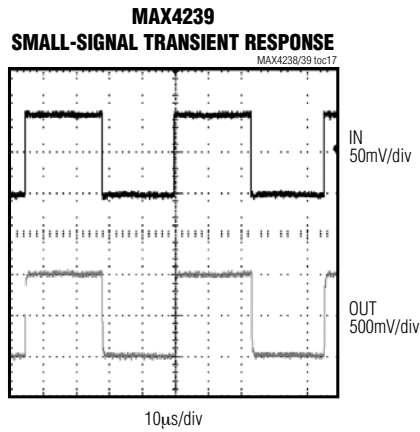
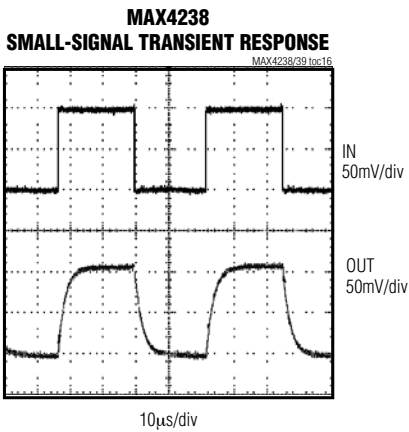
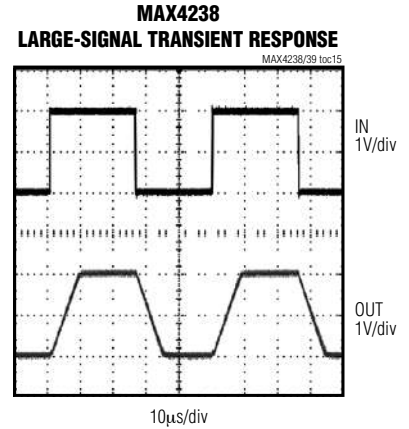
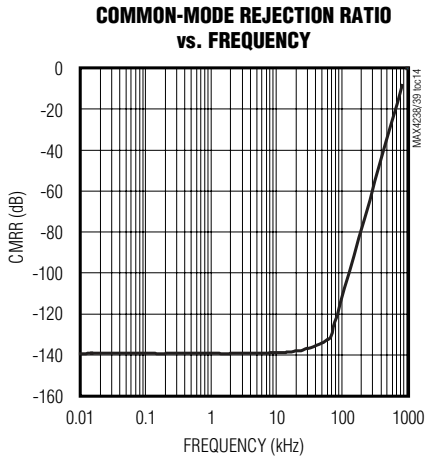
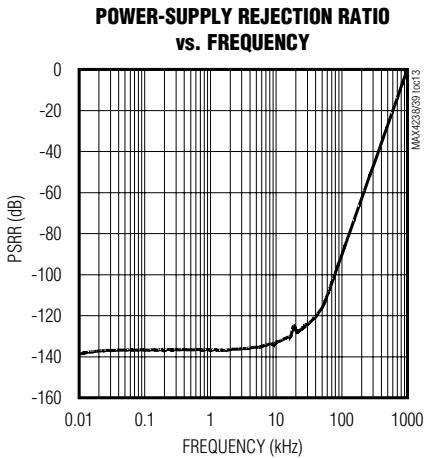
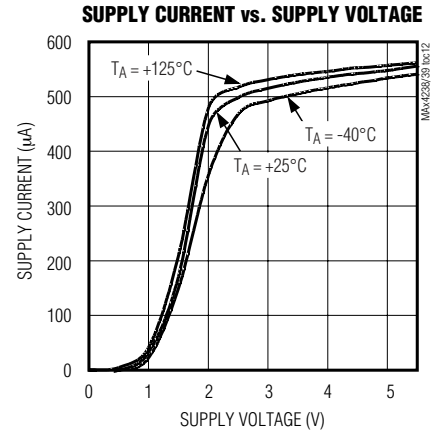
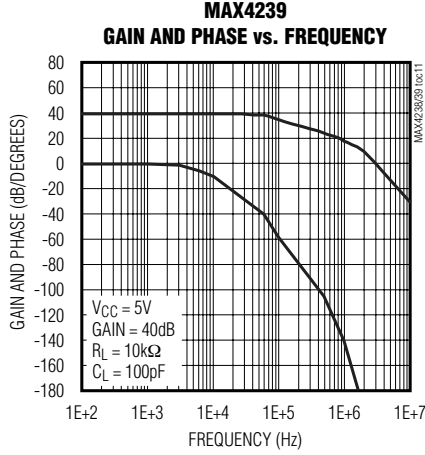
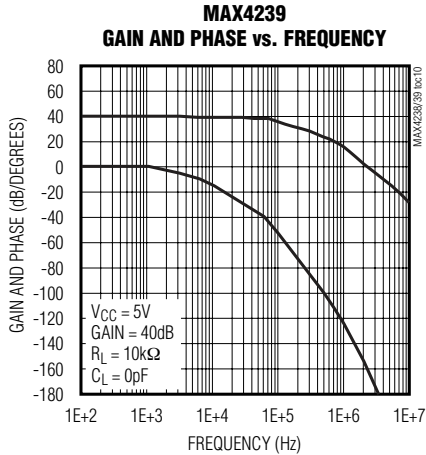

Ultra-Low Offset/Drift, Low-Noise, Precision SOT23 Amplifiers

MAX4238/MAX4239

Typical Operating Characteristics (continued)

($V_{CC} = 5V$, $V_{CM} = 0V$, $R_L = 10k\Omega$ connected to $V_{CC}/2$, $\overline{SHDN} = V_{CC}$, $T_A = +25^\circ C$, unless otherwise noted.)

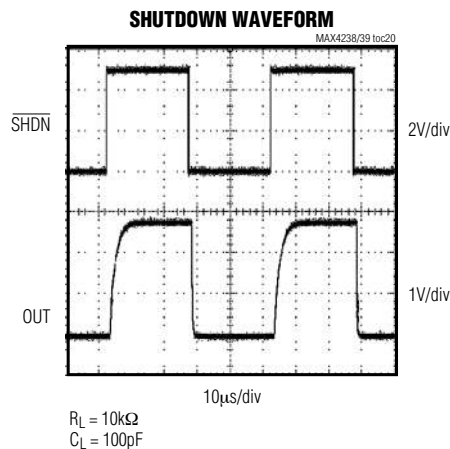
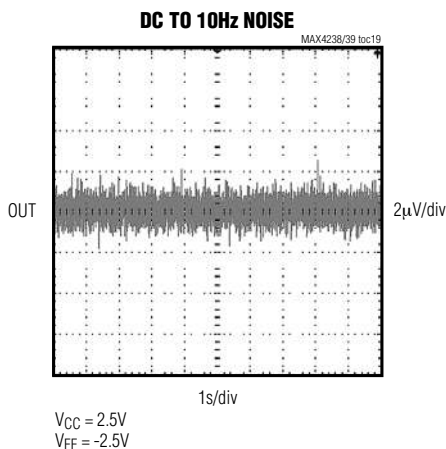

Pin Description

PIN			NAME	FUNCTION
TDFN	SOT23	SO		
1	1	6	OUT	Amplifier Output
2	2	4	GND	Ground
3	3	3	IN+	Noninverting Input
4	4	2	IN-	Inverting Input
5	5	1	\overline{SHDN}	Shutdown Input. Active-low shutdown, connect to V_{CC} for normal operation.
6	6	7	V_{CC}	Positive Power Supply
—	—	5, 8	N.C.	No Connection. Not internally connected.
EP	—	—	EP	Exposed Pad. Connect EP to GND.

Detailed Description

The MAX4238/MAX4239 are high-precision amplifiers that have less than 2.5µV of input-referred offset and low 1/f noise. These characteristics are achieved through a patented autozeroing technique that samples and cancels the input offset and noise of the amplifier. The pseudorandom clock frequency varies from 10kHz to 15kHz, reducing intermodulation distortion present in chopper-stabilized amplifiers.

Offset Error Sources

To achieve very low offset, several sources of error common to autozero-type amplifiers need to be considered. The first contributor is the settling of the sampling capacitor. This type of error is independent of input-source impedance, or the size of the external gain-setting resistors. Maxim uses a patented design technique to avoid large changes in the voltage on the sampling capacitor to reduce settling time errors.

The second error contributor, which is present in both autozero and chopper-type amplifiers, is the charge injection from the switches. The charge injection appears as current spikes at the input, and combined with the impedance seen at the amplifier's input, contributes to input offset voltage. Minimize this feedthrough by reducing the size of the gain-setting resistors and the input-source impedance. A capacitor in parallel with the feedback resistor reduces the amount of clock feedthrough to the output by limiting the closed-loop bandwidth of the device.

The design of the MAX4238/MAX4239 minimizes the effects of settling and charge injection to allow specification of an input offset voltage of 0.1µV (typ) and less than 2.5µV over temperature (-40°C to +85°C).

1/f Noise

1/f noise, inherent in all semiconductor devices, is inversely proportional to frequency. 1/f noise increases 3dB/octave and dominates amplifier noise at lower frequencies. This noise appears as a constantly changing voltage in series with any signal being measured. The MAX4238/MAX4239 treat 1/f noise as a slow varying offset error, inherently canceling the 1/f noise.

Ultra-Low Offset/Drift, Low-Noise, Precision SOT23 Amplifiers

Output Overload Recovery

Autozeroing amplifiers typically require a substantial amount of time to recover from an output overload. This is due to the time it takes for the null amplifier to correct the main amplifier to a valid output. The MAX4238/MAX4239 require only 3.3ms to recover from an output overload (see *Electrical Characteristics* and *Typical Operating Characteristics*).

Shutdown

The MAX4238/MAX4239 feature a low-power (0.1µA) shutdown mode. When $\overline{\text{SHDN}}$ is pulled low, the clock stops and the device output enters a high-impedance state. Connect $\overline{\text{SHDN}}$ to V_{CC} for normal operation.

Applications Information

Minimum and Maximum Gain Configurations

The MAX4238 is a unity-gain stable amplifier with a gain-bandwidth product (GBWP) of 1MHz. The MAX4239 is decompensated for a GBWP of 6.5MHz and is stable with a gain of 10V/V. Unlike conventional operational amplifiers, the MAX4238/MAX4239 have a maximum gain specification. To maintain stability, set the gain of the MAX4238 between $A_V = 1000V/V$ to 1V/V, and set the gain of the MAX4239 between $A_V = 6700V/V$ and 10V/V.

ADC Buffer Amplifier

The low offset, fast settling time, and 1/f noise cancellation of the MAX4238/MAX4239 make these devices ideal for ADC buffers. The MAX4238/MAX4239 are well suited for low-speed, high-accuracy applications such as strain gauges (see *Typical Application Circuit*).

Error Budget Example

When using the MAX4238/MAX4239 as an ADC buffer, the temperature drift should be taken into account when determining the maximum input signal. With a typical offset drift of 10nV/°C, the drift over a 10°C range is 100nV. Setting this equal to 1/2LSB in a 16-bit system yields a full-scale range of 13mV. With a single 2.7V supply, an acceptable closed-loop gain is $A_V = 200$. This provides sufficient gain while maintaining headroom.

Pin Configurations

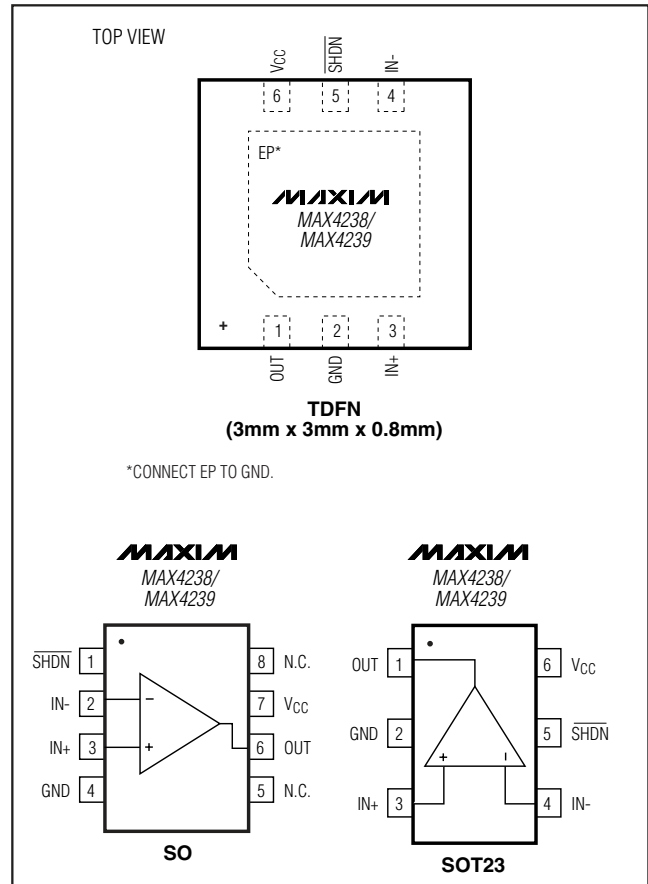

Chip Information

TRANSISTOR COUNT: 821

PROCESS: BiCMOS

Ultra-Low Offset/Drift, Low-Noise, Precision SOT23 Amplifiers

Package Information

(The package drawing(s) in this data sheet may not reflect the most current specifications. For the latest package outline information, go to www.maxim-ic.com/packages.)

MAX4238/MAX4239

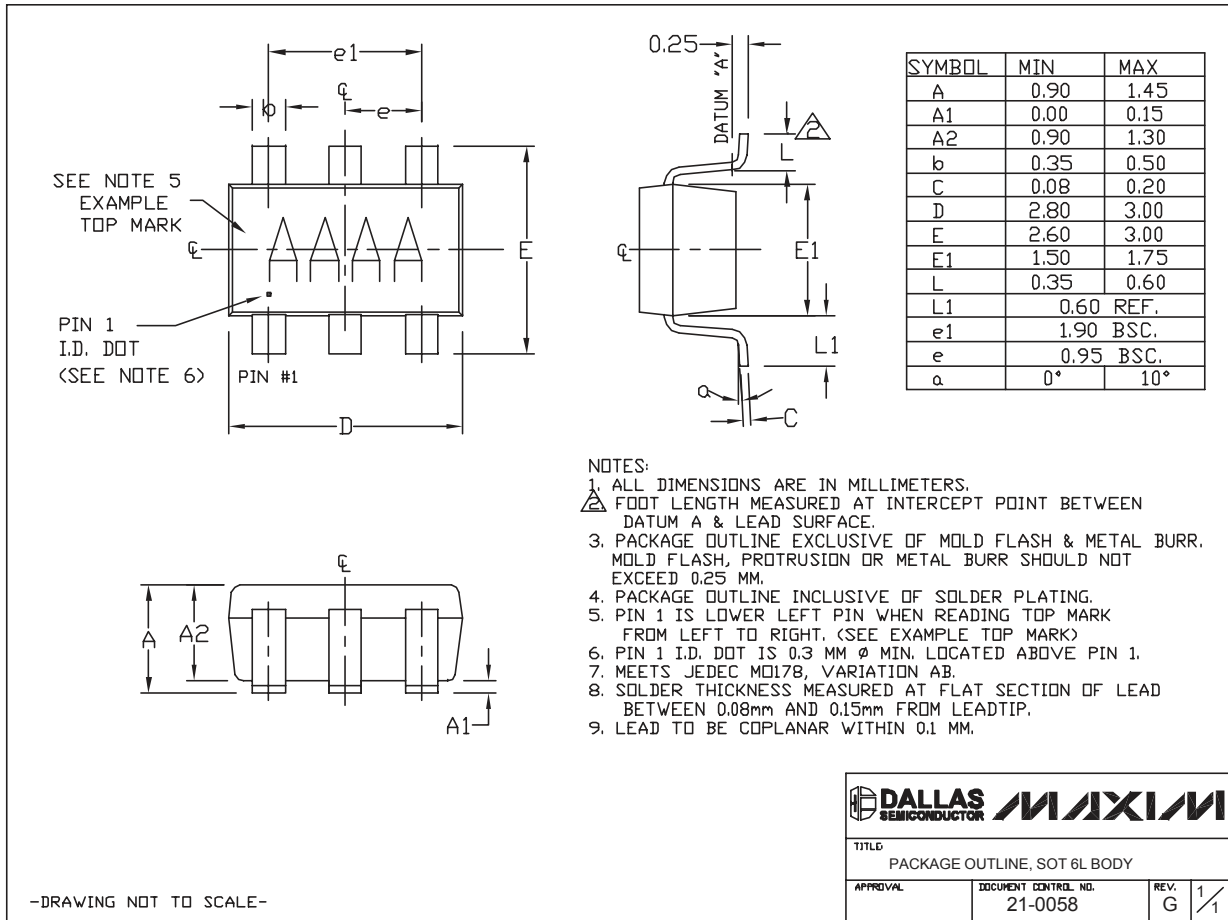

6LSOT.EPS

Ultra-Low Offset/Drift, Low-Noise, Precision SOT23 Amplifiers

Package Information (continued)

(The package drawing(s) in this data sheet may not reflect the most current specifications. For the latest package outline information, go to www.maxim-ic.com/packages.)

SOICN.EPS

DIM	INCHES		MILLIMETERS	
	MIN	MAX	MIN	MAX
A	0.053	0.069	1.35	1.75
A1	0.004	0.010	0.10	0.25
B	0.014	0.019	0.35	0.49
C	0.007	0.010	0.19	0.25
e	0.050 BSC		1.27 BSC	
E	0.150	0.157	3.80	4.00
H	0.228	0.244	5.80	6.20
L	0.016	0.050	0.40	1.27

VARIATIONS:

DIM	INCHES		MILLIMETERS		N	MS012
	MIN	MAX	MIN	MAX		
D	0.189	0.197	4.80	5.00	8	AA
D	0.337	0.344	8.55	8.75	14	AB
D	0.386	0.394	9.80	10.00	16	AC

NOTES:

1. D&E DO NOT INCLUDE MOLD FLASH.
2. MOLD FLASH OR PROTRUSIONS NOT TO EXCEED 0.15mm (.006").
3. LEADS TO BE COPLANAR WITHIN 0.10mm (.004").
4. CONTROLLING DIMENSION: MILLIMETERS.
5. MEETS JEDEC MS012.
6. N = NUMBER OF PINS.

PROPRIETARY INFORMATION

TITLE:
PACKAGE OUTLINE, .150" SOIC

APPROVAL	DOCUMENT CONTROL NO. 21-0041	REV. B	1/1
----------	--	------------------	------------

Ultra-Low Offset/Drift, Low-Noise, Precision SOT23 Amplifiers

Package Information (continued)

(The package drawing(s) in this data sheet may not reflect the most current specifications. For the latest package outline information, go to www.maxim-ic.com/packages.)

MAX4238/MAX4239

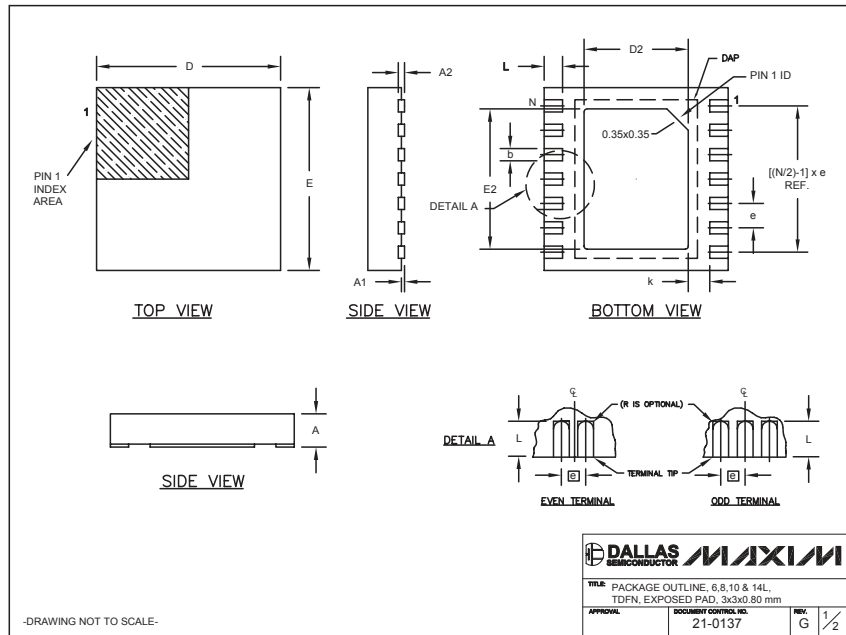

COMMON DIMENSIONS							
SYMBOL	MIN.	MAX.					
A	0.70	0.80					
D	2.90	3.10					
E	2.90	3.10					
A1	0.00	0.05					
L	0.20	0.40					
k	0.25 MIN.						
A2	0.20 REF.						

PACKAGE VARIATIONS								
PKG. CODE	N	D2	E2	e	JEDEC SPEC	b	[(N/2)-1] x e	DOWNBONDS ALLOWED
T633-1	6	1.50±0.10	2.30±0.10	0.95 BSC	MO229 / WEEA	0.40±0.05	1.90 REF	NO
T633-2	6	1.50±0.10	2.30±0.10	0.95 BSC	MO229 / WEEA	0.40±0.05	1.90 REF	NO
T833-1	8	1.50±0.10	2.30±0.10	0.65 BSC	MO229 / WEEC	0.30±0.05	1.95 REF	NO
T833-2	8	1.50±0.10	2.30±0.10	0.65 BSC	MO229 / WEEC	0.30±0.05	1.95 REF	NO
T833-3	8	1.50±0.10	2.30±0.10	0.65 BSC	MO229 / WEEC	0.30±0.05	1.95 REF	YES
T1033-1	10	1.50±0.10	2.30±0.10	0.50 BSC	MO229 / WEED-3	0.25±0.05	2.00 REF	NO
T1433-1	14	1.70±0.10	2.30±0.10	0.40 BSC	----	0.20±0.05	2.40 REF	YES
T1433-2	14	1.70±0.10	2.30±0.10	0.40 BSC	----	0.20±0.05	2.40 REF	NO

NOTES:

- ALL DIMENSIONS ARE IN mm, ANGLES IN DEGREES.
- COPLANARITY SHALL NOT EXCEED 0.08 mm.
- WARPAGE SHALL NOT EXCEED 0.10 mm.
- PACKAGE LENGTH/PACKAGE WIDTH ARE CONSIDERED AS SPECIAL CHARACTERISTIC(S).
- DRAWING CONFORMS TO JEDEC MO229, EXCEPT DIMENSIONS "D2" AND "E2", AND T1433-1 & T1433-2.
- "N" IS THE TOTAL NUMBER OF LEADS.
- NUMBER OF LEADS SHOWN ARE FOR REFERENCE ONLY.

DALLAS SEMICONDUCTOR **MAXIM**

TITLE: PACKAGE OUTLINE, 6,8,10 & 14L, TDFN, EXPOSED PAD, 3x3x0.80 mm

APPROVAL: _____ DOCUMENT CONTROL NO. 21-0137 REV. G 2/2

-DRAWING NOT TO SCALE-

MAX4238/MAX4239 Package Code: T633-2

Maxim cannot assume responsibility for use of any circuitry other than circuitry entirely embodied in a Maxim product. No circuit patent licenses are implied. Maxim reserves the right to change the circuitry and specifications without notice at any time.

Maxim Integrated Products, 120 San Gabriel Drive, Sunnyvale, CA 94086 408-737-7600 _____ 11



SITE SEARCH

PART NO. SEARCH

MAX4238

Part Number Table

Notes:

1. See the [MAX4238 QuickView Data Sheet](#) for further information on this product family or download the [MAX4238 full data sheet](#) (PDF, 388kB).
2. Other options and links for purchasing parts are listed at: <http://www.maxim-ic.com/sales>.
3. [Didn't Find What You Need?](#) Ask our applications engineers. Expert assistance in finding parts, usually within one business day.
4. Part number suffixes: T or T&R = tape and reel; + = RoHS/lead-free; # = RoHS/lead-exempt. More: See [full data sheet](#) or [Part Naming Conventions](#).
5. * Some packages have variations, listed on the drawing. "PkgCode/Variation" tells which variation the product uses.

Part Number	Free Sample	Buy Direct	Package: TYPE PINS SIZE DRAWING CODE/ VAR *	Temp	RoHS/ Lead-Free? Materials Analysis
MAX4238ASA	Sample	Buy	SOIC; 8 pin; .150" Dwg: 21-0041B (PDF) Use pkgcode/variation: S8-4*	-40°C to +125°C	RoHS/Lead-Free: No Materials Analysis
MAX4238ASA-T		Buy	SOIC; 8 pin; .150" Dwg: 21-0041B (PDF) Use pkgcode/variation: S8-4*	-40°C to +125°C	RoHS/Lead-Free: No Materials Analysis
MAX4238ASA+	Sample	Buy	SOIC; 8 pin; .150" Dwg: 21-0041B (PDF) Use pkgcode/variation: S8+ 4*	-40°C to +125°C	RoHS/Lead-Free: Yes Materials Analysis
MAX4238ASA+ T		Buy	SOIC; 8 pin; .150" Dwg: 21-0041B (PDF) Use pkgcode/variation: S8+ 4*	-40°C to +125°C	RoHS/Lead-Free: Yes Materials Analysis
MAX4238AUT+	Sample	Buy		-40°C to +125°C	RoHS/Lead-Free: Yes
MAX4238AUT+ T		Buy		-40°C to +125°C	RoHS/Lead-Free: Yes

MAX4238AUT# G16	Sample	Buy	SOT-23;6 pin; Dwg: 21-00581 (PDF) Use pkgcode/variation: U6FH-6*	-40°C to + 125°C RoHS/Lead-Free: Yes Materials Analysis
MAX4238AUT	Sample	Buy	SOT-23;6 pin; Dwg: 21-00581 (PDF) Use pkgcode/variation: U6F-6*	-40°C to + 125°C RoHS/Lead-Free: No Materials Analysis
MAX4238AUT# TG16		Buy	SOT-23;6 pin; Dwg: 21-00581 (PDF) Use pkgcode/variation: U6FH-6*	-40°C to + 125°C RoHS/Lead-Free: Yes Materials Analysis
MAX4238AUT-T		Buy	SOT-23;6 pin; Dwg: 21-00581 (PDF) Use pkgcode/variation: U6F-6*	-40°C to + 125°C RoHS/Lead-Free: No Materials Analysis
MAX4238AUT-TG16		Buy	SOT-23;6 pin; Dwg: 21-00581 (PDF) Use pkgcode/variation: U6F-6*	-40°C to + 125°C RoHS/Lead-Free: No Materials Analysis
MAX4238ATT+	Sample	Buy	THIN QFN (Dual);6 pin;3X3X0.8mm Dwg: 21-01371 (PDF) Use pkgcode/variation: T633+ 2*	-40°C to + 125°C RoHS/Lead-Free: Yes Materials Analysis
MAX4238ATT+ T		Buy	THIN QFN (Dual);6 pin;3X3X0.8mm Dwg: 21-01371 (PDF) Use pkgcode/variation: T633+ 2*	-40°C to + 125°C RoHS/Lead-Free: Yes Materials Analysis

[Didn't Find What You Need?](#)

 [CONTACT US: FEEDBACK, QUESTIONS](#)
 [RATE THIS PAGE](#)
 [MAIL THIS PAGE](#)

Copyright © 2007 by Maxim Integrated Products, Dallas Semiconductor • [Legal Notices](#) • [Privacy Policy](#)



SITE SEARCH

PART NO. SEARCH

MAX4239

Part Number Table

Notes:

1. See the [MAX4239 QuickView Data Sheet](#) for further information on this product family or download the [MAX4239 full data sheet](#) (PDF, 388kB).
2. Other options and links for purchasing parts are listed at: <http://www.maxim-ic.com/sales>.
3. [Didn't Find What You Need?](#) Ask our applications engineers. Expert assistance in finding parts, usually within one business day.
4. Part number suffixes: T or T&R = tape and reel; + = RoHS/lead-free; # = RoHS/lead-exempt. More: See [full data sheet](#) or [Part Naming Conventions](#).
5. * Some packages have variations, listed on the drawing. "PkgCode/Variation" tells which variation the product uses.

Part Number	Free Sample	Buy Direct	Package: TYPE PINS SIZE DRAWING CODE/ VAR *	Temp	RoHS/ Lead-Free? Materials Analysis
MAX4239ASA	<input type="button" value="Sample"/>	<input type="button" value="Buy"/>	SOIC;8 pin;.150" Dwg: 21-0041B (PDF) Use pkgcode/variation: S8-4*	-40°C to + 125°C	RoHS/Lead-Free: No Materials Analysis
MAX4239ASA-T		<input type="button" value="Buy"/>		-40°C to + 125°C	RoHS/Lead-Free: No
MAX4239ASA+	<input type="button" value="Sample"/>	<input type="button" value="Buy"/>	SOIC;8 pin;.150" Dwg: 21-0041B (PDF) Use pkgcode/variation: S8+ 4*	-40°C to + 125°C	RoHS/Lead-Free: Yes Materials Analysis
MAX4239ASA+ T		<input type="button" value="Buy"/>		-40°C to + 125°C	RoHS/Lead-Free: Yes
MAX4239AUT# TG16		<input type="button" value="Buy"/>		-40°C to + 125°C	RoHS/Lead-Free: No
MAX4239AUT	<input type="button" value="Sample"/>	<input type="button" value="Buy"/>	SOT-23;6 pin; Dwg: 21-00581 (PDF)	-40°C to + 125°C	RoHS/Lead-Free: No Materials Analysis

MAX4239AUT-T	Buy	Use pkgcode/variation: U6F-6* SOT-23;6 pin; Dwg: 21-00581 (PDF) Use pkgcode/variation: U6F-6*	-40°C to +125°C RoHS/Lead-Free: No Materials Analysis
MAX4239ATT+ T	Buy	THIN QFN (Dual);6 pin;3X3X0.8mm Dwg: 21-01371 (PDF) Use pkgcode/variation: T633+2*	-40°C to +125°C RoHS/Lead-Free: Yes Materials Analysis
MAX4239ATT+	Sample Buy	THIN QFN (Dual);6 pin;3X3X0.8mm Dwg: 21-01371 (PDF) Use pkgcode/variation: T633+2*	-40°C to +125°C RoHS/Lead-Free: Yes Materials Analysis

[Didn't Find What You Need?](#)



[CONTACT US: FEEDBACK, QUESTIONS](#)



[R★R★ RATE THIS PAGE](#)



[MAIL THIS PAGE](#)