

Ratings
 Voltage: 150 V
 Temperature: -40~70 °C

Conductor
 Conductor count: 5
 Gauge: 24 AWG 0.21 mm²
 Material: Tinned copper strands
 Strand size: $\varnothing 0.08 \times 41$
 Resistance at 20 °C: 95 Ω /km max

Insulator
 Material: HDPE
 Color: white, black, red, yellow, white
 Diameter: $\varnothing 1.05 \pm 0.10$ mm
 Nominal thickness: 0.22 mm
 Resistance at 20 °C: 100 M Ω /km min

Wrap
 Material: cotton paper

Filler
 Material: aramid fiber

Outer jacket
 Material: TPU
 Color: gray
 Diameter: $\varnothing 4.1 \pm 0.25$ mm
 Nominal thickness: 0.50 mm

Tests
 Tensile strength: 26 kgf min
 Dielectric test: 1500 V dc for 1 minute without breakdown
 Bend test at 200 g, $\pm 60^\circ$, 30 cycles /min: 15,000 cycle minimum

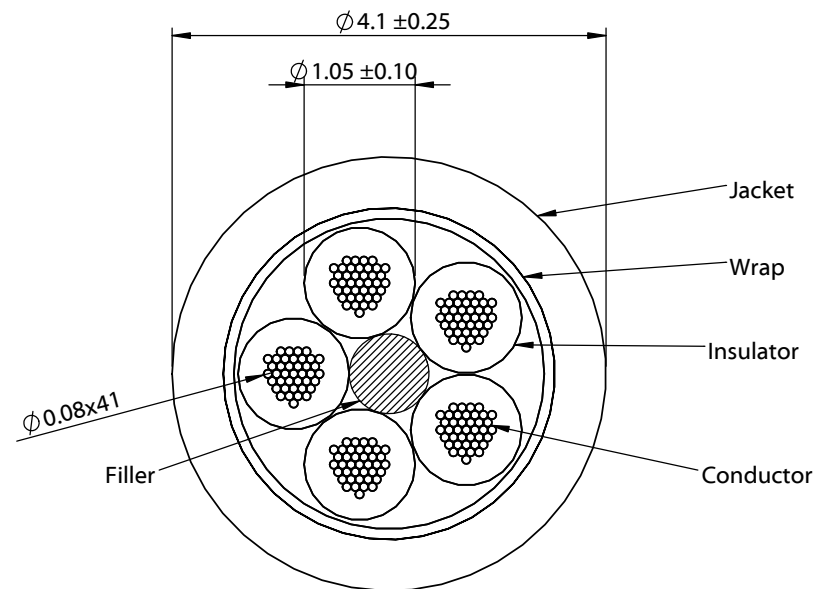
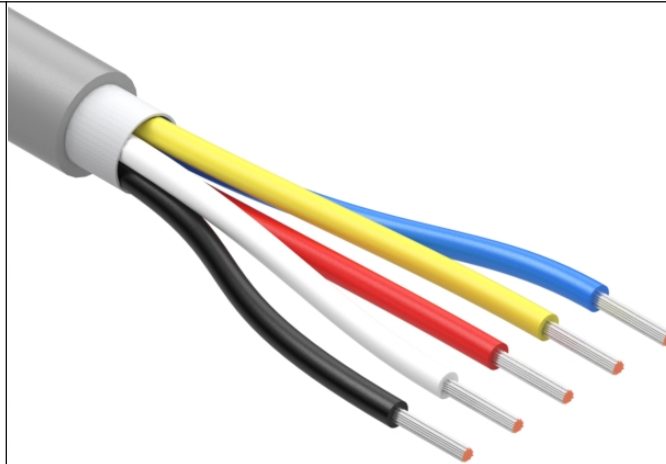

Revision:	Date:	Description:
A	9/9/2022	Initial release

Prepared: **MP**
Digitally signed by MP
 Date: 2022.09.22 09:31:07 -07'00'

Verified: **PB**
Digitally signed by PB
 Date: 2022.09.23 11:29:52 -07'00'

Dimensions are in millimeters.
 Tolerances:
 X: ± 0.5 mm
 X.X: ± 0.3 mm
 X.XX: ± 0.05 mm

Notes:
 RoHS compliant
 Jacket meets ISO 10993 Biological Compatibility
 Phthalate and halogen free
 Function test: no open, no short, no intermittent

Description:
 Wire, 5C TS, 24 AWG, 150V, 70C, 4.1 mm, TPU, 75A, gray, WBL

TENSILITY

tel 1.541.323.3228 800 877.670.7118
 fax 1.541.323.4202 web tensility.com

Size: A Part number: 30-02729

Scale: 14:1 Sheet 1 of 1