

## Introduction

Designed in accordance with EIA standard RS-310, Vector subracks and modules offer versatility within a 19" rackmount format. All racks are adjustable in both height and depth, offering standard product solutions for standard and custom requirements.

All Subrack sizes are compatible with Vector prototyping boards (see Vectorbord section), and can accommodate other sizes as well. Several card guide types (metal or plastic, snap-in, rivet, or screw-down) are available.

## Cages

VectorPak® Subrack and Module Subrack Types by Part Number Stem:

**CCK** - Card Cage frame kit. Kits with no card guides use 'F' in number (e.g., CCK13F/90). Other kits have 21 pair of guides included: 'S'= plastic snap-in type e.g., CCK13S/90; 'M' or 'P'= metal or plastic, fastened with hardware. Guide spacing is .25".

**CCA** - Same as CCK version, but all are **assembled with guides**.

**CMA** - Assembled **Module Subrack** for EFP modules. Modules available separately.

**CCM** - Assembled rack for **Card Mount Modules** (CM type). Modules available separately.

For Rack Accessories see page 41A

For Desktop outer enclosure, see page 42

New Item: CCK19F/90 (For max 11.5" x 13.5" cards)



Subrack Kits (CCK)



Assembled Subracks with Continuous Guide Plate



Assembled Module Subracks (CMA)



Assembled Subracks with Card Guides (CCA)



Assembled Card Mount Subracks (CCM)

### CCK - 13 - S - /90

#### Model Type

- CCK - Kit only with snap-in card guides
- CCA - Factory assembled version of CCK with snap-in card guides
- CCM - Factory assembled card mount cage with snap-in card guides
- CMA - Assembled module cage with module guides

#### Series Number (Max. Card Size)

- 12 - 3U (5.25") X 19" X 9" (4.5" X 4.5")  
21 pair Card Guides included
- 13 - 3U (5.25") X 19" X 9" (4.5" X 6.5")  
21 pair Card Guides included
- 14 - 3U (5.25") X 19" X 12" (4.5" X 9.6")
- 16 - 3U (5.25") X 19" X 15.75" (4.5" X 13.5")
- 15 - 4U (7.00") X 19" X 12" (6.25" X 9.6")
- 20 - 4U (7.00") X 19" X 15.75" (6.25" X 13.5")
- 17 - 5U (8.75") X 19" X 12" (8.00" X 11.0")
- 18 - 6U (10.50") X 19" X 15.75" (9.75" X 13.5")
- 19 - 7U (12.25") X 19" X 15.75" (11.5" X 13.5")
- 100 - 7U (12.25") X 19" X 9.00" (11.5" X 7")

Note: /90 denotes side walls with .200" slot width  
On CCA, K frames only also denotes snap-in version

#### CCK Type

- F - Frame only, snap-in plastic, metal or plastic screw-down card guides available separately
- C - Continuous guide plate, assembled cage only
- S - Snap-in guides included
- M - Screw-in Aluminum card guides
- P - Screw-in plastic card guides

#### CMA 13 or 14 - XX/90

- 16 - Designed for 1.6" wide EFP modules
- 20 - Designed for 2.0" wide EFP modules
- 30 - Designed for 3.0" wide EFP modules

For Front Door Panels and Covers see page 41A

11115 Vanowen St., North Hollywood, CA 91605 Phone (818) 985-8208

Toll-Free (800) 423-5659

Web site: <http://www.vectorelect.com>

**VECTOR**  
ELECTRONICS & TECHNOLOGY, INC.  
A Fine Technology Group

# Cardmount Subracks

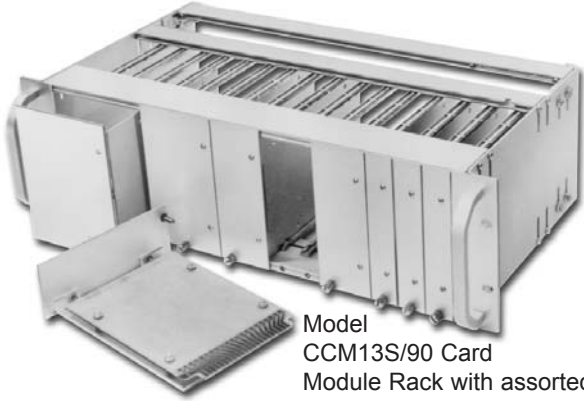

Model CCM13S/90 Card Module Rack with assorted cardmount modules

- Accepts CM45A65 Card Mount Modules
- Card guide positions are variable at .25" increments
- Assembled module rack - plastic snap-in install on 1" centers
- Different width modules may be inserted interchangeable without guide changes
- Card mount modules (CM Series) with 1" to 4" widths
- For 3U and 4U applications
- Adjustable rear struts for connection of backplanes (struts available separately)
- .062" thick aluminum plates are inserted into guide; PC Card is attached firmly to plate
- Front panels on card mount may be removed for custom punching, plating and printing
- Modules may be secured by thumb screws (SC10-3A, 10-32 included)
- For Desktop outer enclosure, see page 42

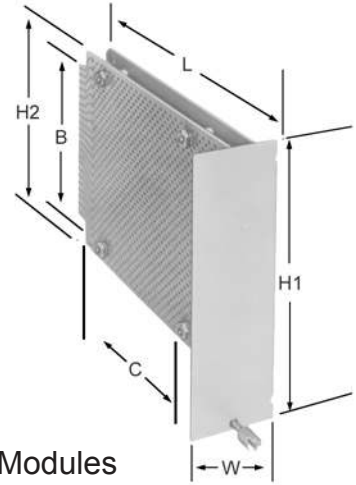

Card Mount Modules

Part No.	Height		Width	Length			Module Rack	Card Guide
	H1	H2		B	C	L		
CM45A65-1	5.25"	4.5"	1.0"	6.57"	3.8"	3.6"	CCM13S	CG2-65
CM45A65-2	5.25"	4.5"	2.0"	6.57"	3.8"	3.6"	CCM13S	CG2-65
CM45A65-4	5.25"	4.5"	4.0"	6.57"	3.8"	3.6"	CCM13S	CG2-65
CM45B95-1	5.25"	4.5"	1.0"	9.57"	3.8"	6.6"	CCM14S	CG2-95
CM45B95-2	5.25"	4.5"	2.0"	9.57"	3.8"	6.6"	CCM14S	CG2-95
CM45B95-4	5.25"	4.5"	4.0"	9.57"	3.8"	3.6"	CCM14S	CG2-95
CM62F95-1	7.0"	6.25"	1.0"	9.57"	5.5"	6.6"	CCM15S	CG2-95
CM62F95-2	7.0"	6.25"	2.0"	9.57"	5.5"	6.6"	CCM15S	CG2-95
CM62F95-4	7.0"	6.25"	4.0"	9.57"	5.5"	6.6"	CCM15S	CG2-95
CM90F95-1	10.5"	9.00"	1.0"	9.57"	7.6"	6.6"	CCM18S	CG2-95
CM90F95-2	10.5"	9.00"	2.0"	9.57"	7.6"	6.6"	CCM18S	CG2-95
CM90F95-4	10.5"	9.00"	4.0"	9.57"	7.6"	6.6"	CCM18S	CG2-95

Subracks

# Card Guides

## Free Standing Connector Mounted Card Guides

Secure connection, rugged support of 0.062" thick, free standing circuit boards. For applications in which space is at a premium. Several sizes and styles available. Aluminum alloy construction. Mounting hardware included (HD55 Hardware Kit)

Part No.	Use With Connector	A	B	C	D	For Use With
BR27D	R644	.60"	2.96"	.47"	.25"	4.5" wide Plugboards with centered contacts, such as Vector 3677, 3682 and 3662 series

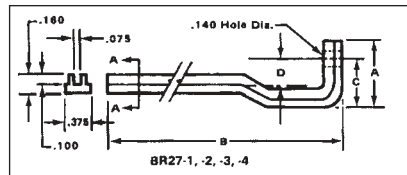
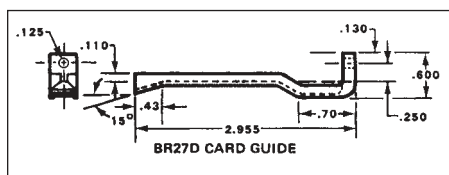

Typical BR27 mounting

(Ordering Table see page 37)

# Module Subracks

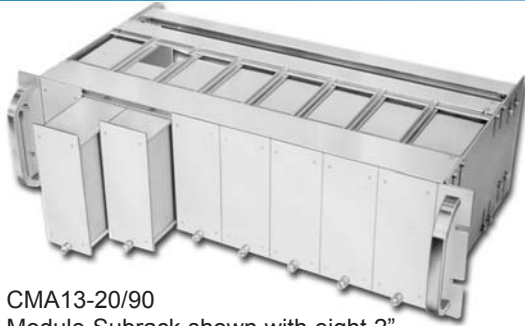

CMA13-20/90  
Module Subrack shown with eight 2" wide EFP Modules (sold separately)

- 1.6", 2.0" and 3.0" evenly spaced modules are accepted
- Side Panels -double screw attachment to wide TSW \ (1.75") metal strut
- Rear Struts-adjustable in width and height-BR16-1 bracket
- Special aluminum extruded case guides and spacers provide secure mounting for modules
- Standard 19" width. Other widths available by special order.
- Filler panels available where mixing widths creates gaps
- Aluminum construction
- Paint or color anodize options available

## CMA Module Racks

These cages provide attractive, sturdy, and mechanically excellent housing to enclose electronic assemblies.

These units have the benefits and features of custom enclosures without the expense.

EFP modules feature aluminum extruded sides to accept PC cards. Extended front panels on modules allow thumb screw locking of module to subrack for easy insertion and extraction. The extended front panel also provides an attractive appearance.

Side panels fasten to sturdy Vector TSW model (1.75" wide) Struts with two screws. Subrack models accept widths of 1.6", 2.0", and 3.0" EFP modules; 4.5" module optional. Rear struts are adjustable in width and height. (Ordering Table see page 37)

# EFP Modules

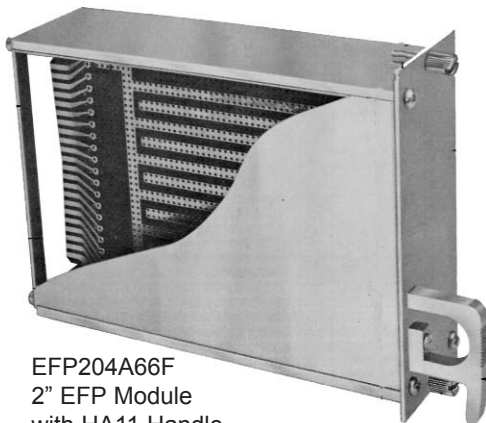

EFP204A66F  
2" EFP Module  
with HA11 Handle

- Extended front panels provide thumb screw mounting & flush fit from module to module & with strut line.
- Modules provide shielding; H.F. shielding optional
- Front panels may be customized -cutouts, printing & color.
- All covers have locking detent; slides out of groove when released
- Supplied in Kit form
- Modules with 6.5" depth accept 4.5" x 6.5" cards
- Modules with 9.7" depth accept 4.5" x 9.6" cards

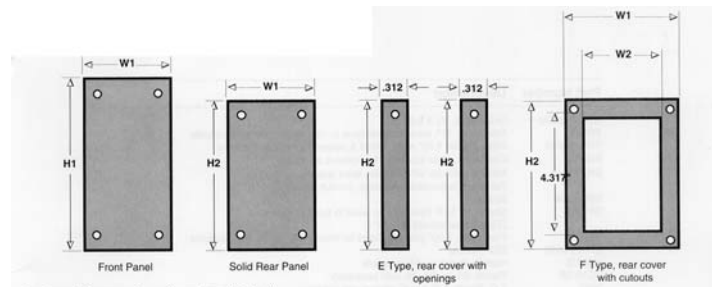

Part No.	Kit Type	L	W1	W2	H1	H2	Full Rear Panel Piece Parts		
							Front Panel#	Rear Cover	F Cutouts
EFP164A66	EFP164A66F	6.5"	1.65"	1.31"	5.22"	4.62"	FP16-52	BP13-4	BP13-4F
EFP164A97	EFP164A97F	9.6"	1.65"	1.31"	5.22"	4.62"	FP16-52	BP13-4	BP13-4F
EFP204A66	EFP204A66F	6.5"	2.05"	1.71"	5.22"	4.62"	FP2A52	BP17-4	BP17-4F
EFP204A97	EFP204A97F	9.6"	2.05"	1.71"	5.22"	4.62"	FP2A52	BP17-4	BP17-4F
EFP304A66	EFP304A66F	6.5"	3.05"	2.71"	5.22"	4.62"	FP3A52	BP27-4	BP27-4F
EFP304A97	EFP304A97F	9.6"	3.05"	2.71"	5.22"	4.62"	FP3A52	BP27-4	BP27-4F
EFP454A66	EFP454A66F	6.5"	4.55"	4.21"	5.22"	4.62"	FP3A52	BP27-4	BP27-4F
EFP454A97	EFP454A97F	9.6"	4.55"	4.21"	5.22"	4.62"	FP45A52	BP42-4	BP42-4F

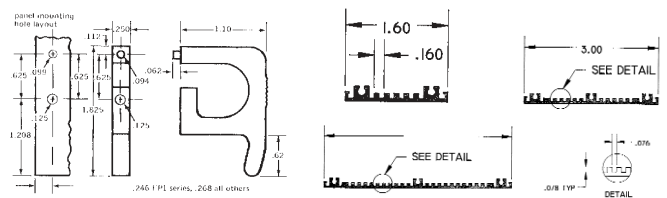

P/N HA11/2 Handle Pkg 2

For Side Panels & Mounting Hardware see page 41B

# Card Guides

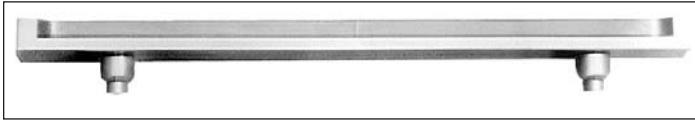

Tapered slot, snap-in card guides provide easy installation/removal

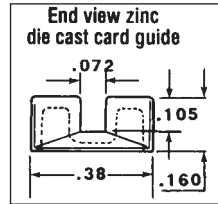
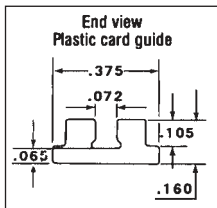
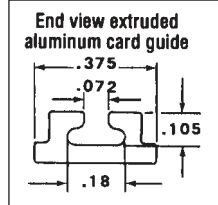
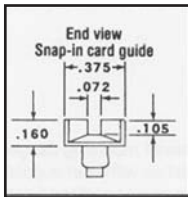

High quality card guides feature tapered slots for easy insertion. Snap-in nylon models provide easy installation and removal without tools, and can be positioned at 0.25" increments when used with Vector-Pak T-struts (TS169-6/90). Screw-mounted models (installation hardware included) are available in metal or plastic and provide variable positioning along entire length of strut. Holes for mounting guides to struts are based on center-to-center multiples of 0.75". All materials are flame retardant.

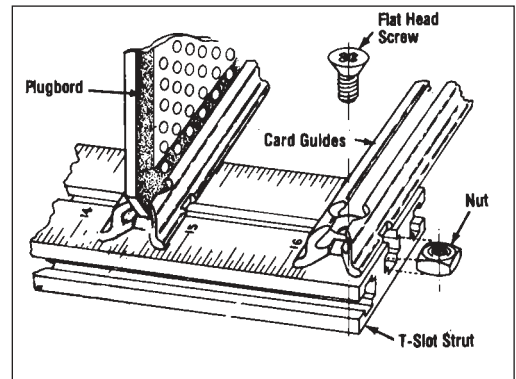

Metal or plastic screw down card guides attach with SC4-27/25 flat head screw and NT4-7PA square nut

Subracks

### Card Guide Ordering Table

Part No.	Type	Length	Centers	Card Length	Application
CG2-45P	Plastic, Screw	2.89"	2.25"	4.50"	Subrack series 12, 13, 14, 17, 18 & 100 and Vector P series sidewalls
CG2-45S	Nylon, Snap-in	3.17"	2.25"	4.50"	
CG2-50P	Plastic, Screw	4.36"	3.75"	5.00"	
CG2-65M	Metal, Screw	5.42"	4.50"	6.50"	
CG2-65P	Plastic, Screw	5.42"	4.50"	6.50"	
CG2-65S	Nylon, Snap-in	5.42"	4.50"	6.50"	Subrack series 14, 15, 17, 18 and 100 and Vector P series sidewalls ending in 119 or 156 CCA19
CG2-80M	Metal, Screw	6.64"	6.00"	8.00"	
CG2-80P	Plastic, Screw	6.64"	6.00"	8.00"	
CG2-80S	Nylon, Snap-in	6.93"	6.00"	8.00"	
CG2-95M	Metal, Screw	8.14"	7.50"	9.50"	
CG2-95P	Plastic, Screw	8.14"	7.50"	9.50"	
CG2-95S	Nylon, Snap-in	8.43"	7.50"	9.50"	
CG2-135M	Metal, Screw	13.19"	12.55"	13.50"	

Packages of 12 ea. Screw-down types include installation hardware and are available in custom lengths on request.

