

CUSTOMER PRINT

PART NUMBER: 18982-XSG-5XX

- NOTES:**
 1. PARTS ARE TO BE BULK PACKED.
 2. CONTACTS ARE ASSEMBLED INTO CONNECTOR.
 3. PARENTHESIS () INDICATE REFERENCE DIMENSION.
 4. DIMENSIONS IN BRACKETS [] ARE IN MILLIMETERS

ASS'Y P/N	CONTACT QTY.	KEY STYLE
18982-5SG-5XX	5 - # 26	A-KEY
18982-6SG-5XX	6 - # 26	B-KEY
18982-7SG-5XX	7 - # 26	A-KEY

NUMBER OF CONTACTS

ASS'Y P/N	CABLE O.D.
18982-XSG-518	0.175 - 0.185 [4.4-4.7]
18982-XSG-521	0.205 - 0.215 [5.2-5.5]
18982-XSG-522	0.215 - 0.225 [5.5-5.7]

GROMMET SIZE

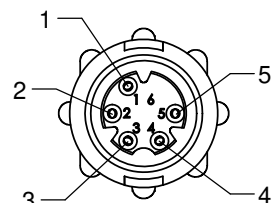

FACE VIEW
 18982-5SG-5XX
 5 POSITION
 A-KEY

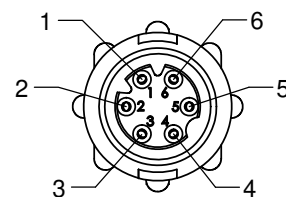

FACE VIEW
 18982-6SG-5XX
 6 POSITION
 B-KEY

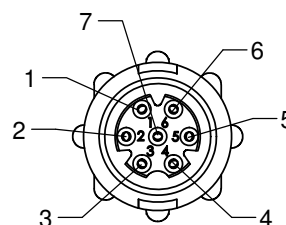

FACE VIEW
 18982-7SG-5XX
 7 POSITION
 A-KEY

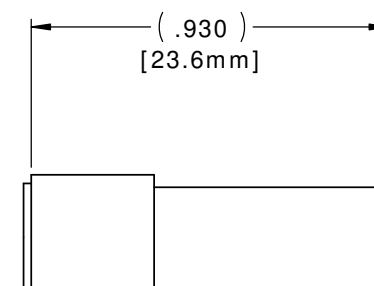
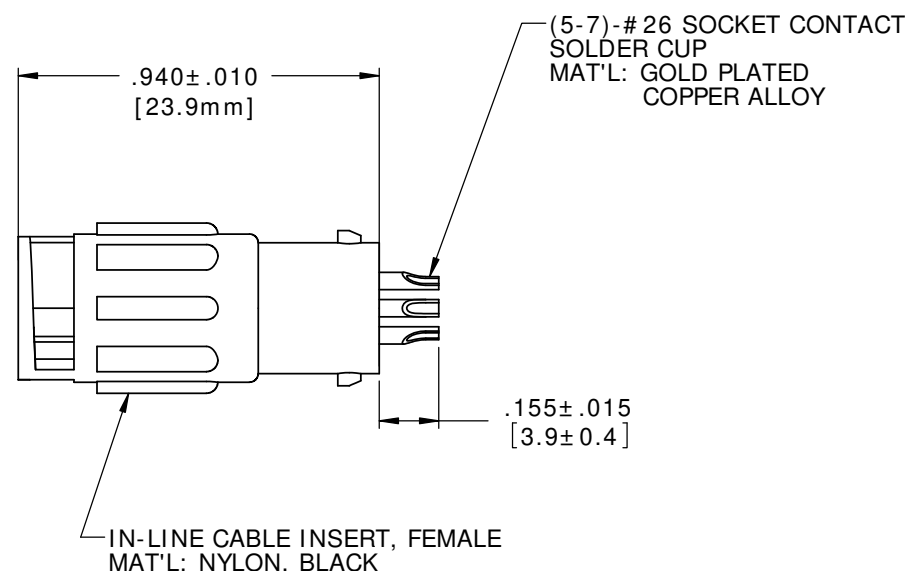

GROMMET
 MAT'L: SANTOPRENE, BLACK

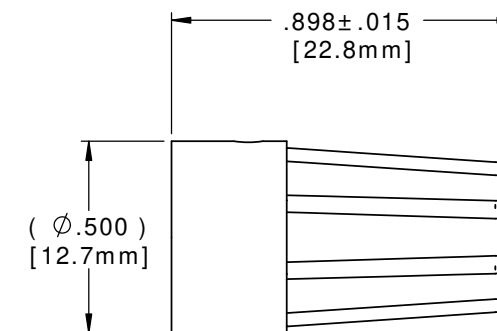

BACKSHELL, LONG
 MAT'L: NYLON, BLACK

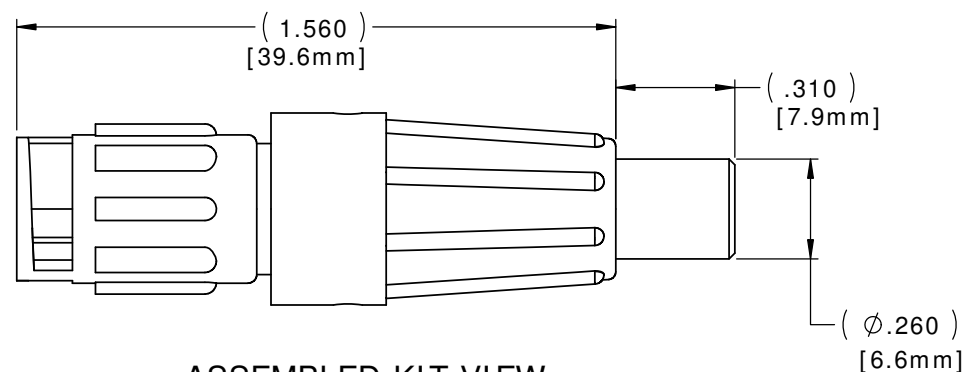

ASSEMBLED KIT VIEW
 FOR CUSTOMER REFERENCE ONLY

CUSTOMER APPROVAL

THIS DOCUMENT CONTAINS CONFIDENTIAL INFORMATION PROPRIETARY TO CONXALL CORPORATION. ANY REPRODUCTION, DISCLOSURE, OR USE OF THIS DOCUMENT / INFORMATION IS EXPRESSLY PROHIBITED UNLESS AUTHORIZED IN WRITING BY CONXALL CORPORATION.

APPROVED BY: _____
 DATE: _____

RoHS COMPLIANT

REV.	INIT.	DATE	DESCRIPTION
D	MA	08-31-18	UPDATE MANUFACTURING DRAWING PER ECR 9211-5
C	AN	01-15-14	DRAWING NO. WAS 18982-XSG-XXX, REMOVED SHORT BACKSHELL ASSEMBLIES, ADDED TOLERANCES AND MATERIALS. PER ECR 8074
B	PD	09-01-11	UPDATE MANUFACTURING DRAWING PER ECR 7959
A	PAK	03-24-10	DRAWING CREATED PER DOR 06-E168CS

ALL INFORMATION ILLUSTRATED IS THE PROPERTY OF CONXALL CORPORATION. UNAUTHORIZED DUPLICATION OR DISTRIBUTION OF THIS DOCUMENT IS PROHIBITED.		ORIG. DRAWN BY: PAK DATE: 03-11-10 CHECKED BY:	601 E. WILDWOOD VILLA PARK, IL 60181
ALL UNITS ARE IN FEET, INCHES, FRACTION OF INCHES, AND DECIMALS.		APPROVED BY: SCALE: NTS SIZE: B SHEET: 1 OF 1 FILE: 18982-XSG-5XX DIRECTORY: SLW	
- CRITICAL CHARACTERISTIC FLAG PER SPEC. XXXX			PART NUMBER: 18982-XSG-5XX REV D