

InGaAs Photodiodes KPDE300-H53

Characteristics

- Large sensitive area
- Low voltage operation
- Custom designed photodiode available

Applications

- Laser power monitors
- Laser diode and LED aging equipment
- Near infrared sensing system
- Power meters

Package

- TO-CAN

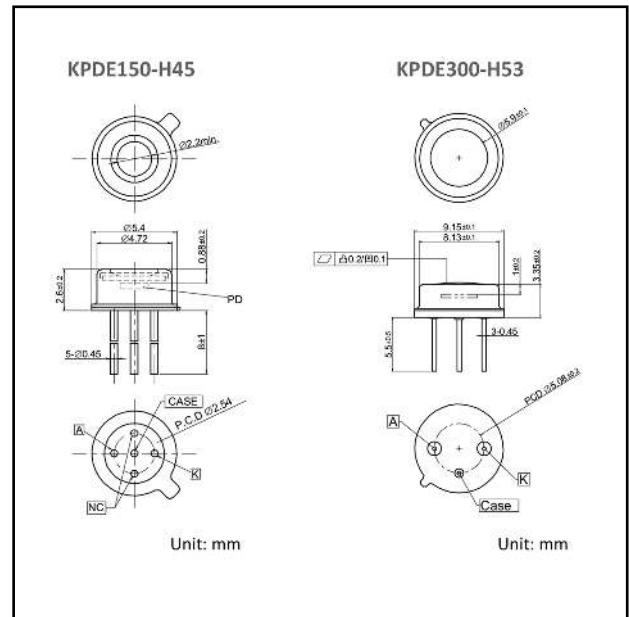

Absolute Maximum Ratings

Parameter	Symbol	Value	Unit	Conditions
Reverse voltage	V_R	2	V	-
Reverse Current	I_R	2	mA	-
Forward current	I_F	2	mA	-
Operating temperature	T_{opr}	-20 to +70	°C	Avoid dew condensation
Storage temperature	T_{stg}	-20 to +80	°C	Avoid dew condensation

Electrical and Optical characteristics (Ta=25°C unless otherwise noted)

Parameter	Symbol	Min.	Typ.	Max.	Unit	Conditions
Active area	S	-	3000	-	μm	-
Sensitive wavelength	λ	900	-	1700	nm	-
Responsivity	R	0.8 0.9	0.9 1.0	-	A/W	$V_R=1V \lambda = 1310nm$ $V_R=1V \lambda = 1550nm$
Dark current	I_D	-	2	-	nA	$V_R=1V$
Total capacitance	C_t	-	1	-	mV	$V_R=1V f=1MHz$

Dark Current - Reverse Voltage

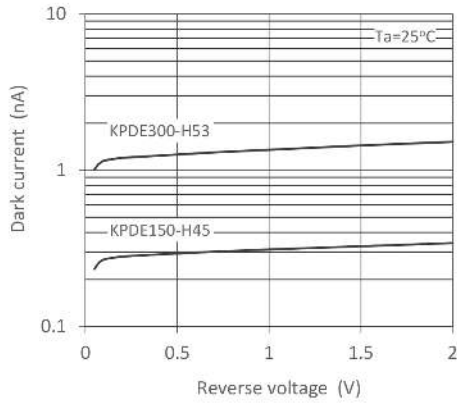

Dark Current - Ambient Temperature

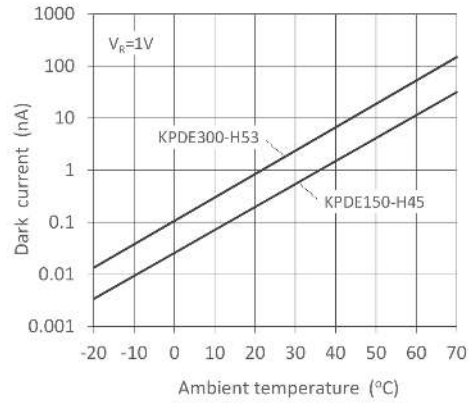

Spectral Responsivity

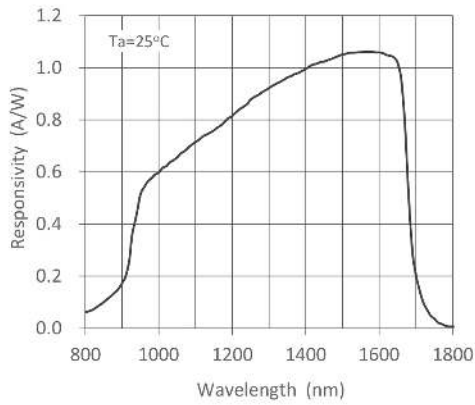

Frequency Response

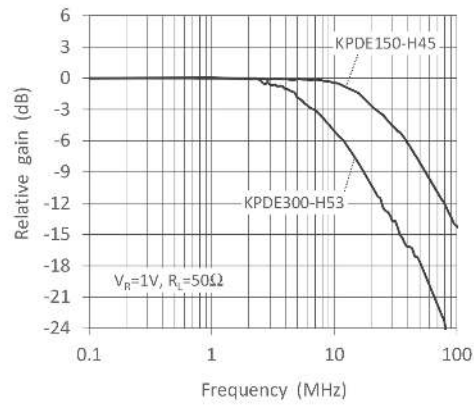

KPDE150-H45 Directivity

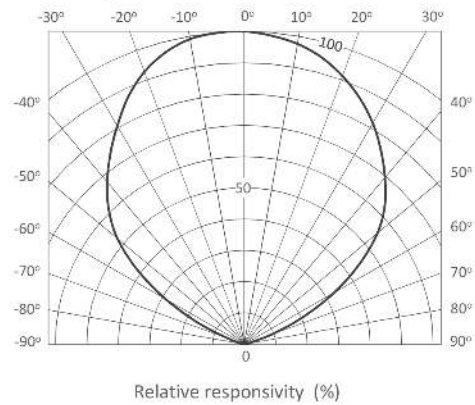

KPDE300-H53 Directivity

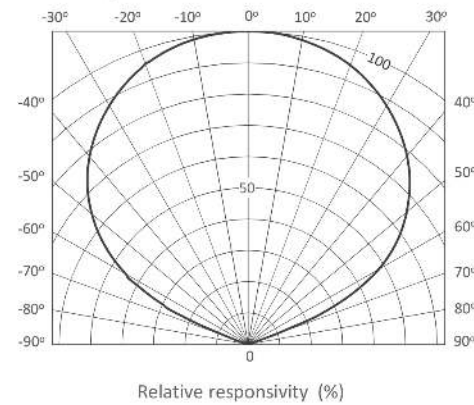

Precautions and disclaimers

Please note the following points regarding the technical information and product usage described in this document.

1. Information such as product specifications, characteristics, data, specification materials, and structures described in this document is subject to change. Before using our products, make sure to order the latest specifications and check the contents.
2. We do not guarantee that your intended use will be satisfied or that our product will actually comply and operate with the equipment that you use.
3. While the information contained in this document has been carefully prepared for the sake of accuracy, Kyoto Semiconductor shall not be liable whatsoever even in the unlikely event that you or a third party suffers damage as a result of the information being incorrect, insufficient, incomplete, or misprinted.
4. Reprinting or reproduction of any part or this entire document without our permission is strictly prohibited.
5. The circuits and usage, etc. included in this document are for reference only. We do not guarantee that there will be no infringement of the intellectual property rights or other rights of the customer or a third party regarding these. We are not liable for any damage related to the infringement of the intellectual property rights or other rights of the customer or a third party.
6. The information contained in this document does not permit the customer to implement or use intellectual property rights or other rights owned or managed by us or a third party.
7. The products included in this document require an extremely high level of reliability, and they are not designed and manufactured for use with equipment or devices (medical equipment, transportation equipment, public transportation equipment, aerospace equipment, nuclear power control devices, fuel control, in-vehicle equipment (excluding car accessories not related to car control), various safety devices, etc.) (hereinafter, "specific application") whose failure or malfunction may cause danger or damage to one's life or health or any other serious damage. We are not liable for any damage caused to you or a third party by using this product or this information for a specific application without obtaining the prior written consent of Kyoto Semiconductor. If you are considering using this product or this information for a specific purpose, please contact our sales office beforehand.
8. For our customers to export this product or the technology we provide, it is necessary to comply with the 'Foreign Exchange and Foreign Trade Act' and the security export control laws and regulations of each country, and follow the procedures stipulated by the said laws and regulations. Do not use this product or this information for purposes such as developing weapons of mass destruction, military use, or other military purposes.
9. This product conforms to the RoHS Directive (2011/65/EU).
10. If you have any inquiries regarding the details of the products described in this document, or if you have any other questions, please feel free to contact us.



KYOTO SEMICONDUCTOR Co.,Ltd.

Kyoto Headquarter Kansai Sales Office

307-21, Nishiote-cho, Fushimi-ku, Kyoto, 612-8362, Japan
TEL:+81 75-605-7314(Kansai Sales Office) FAX:+81 75-605-7312

Tokyo Headquarter Tokyo Sales Office

24th Sky Building 2nd and 4th Floor, 1-34-3, Shinjuku Shinjuku-ku, Tokyo, 160-0022, Japan
TEL:+81 3-5312-5360(Tokyo Sales Office) FAX:+81 3-5312-5367

Kyosemi Opto America Corporation

4655, Old Ironsides Suite, 230, Santa Clara, California, 95054, USA
TEL: +1 408-492-9361 FAX: +1 408-492-9843