

**SPECIFICATIONS** **CSB63CR2GT2C**

### OUTLINES DIMENSIONS

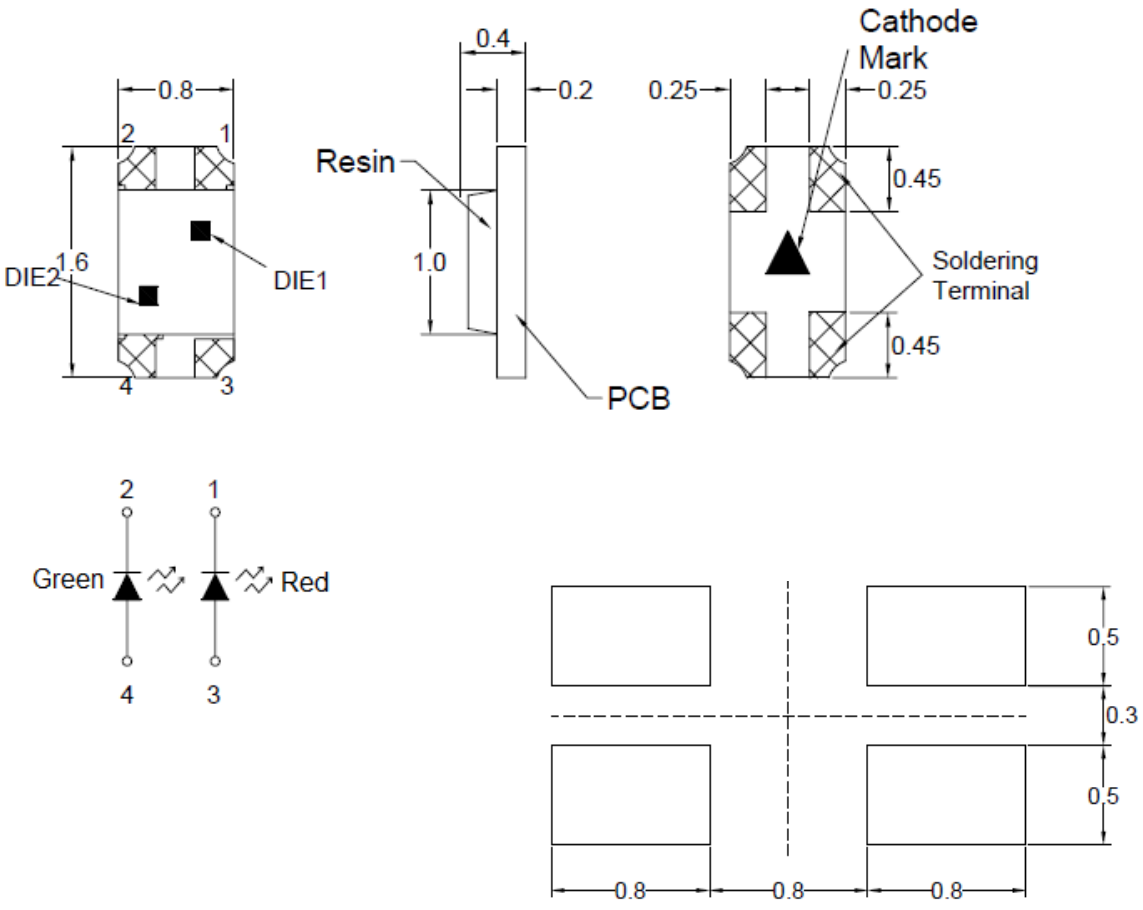

**Notes:**

1. All Dimensions are in millimeters (inches).
2. Tolerance is  $\pm 0.25\text{mm}$  (0.01") unless otherwise noted.
3. Specifications are subject to change without notice.

Part Number	Chip Material	Color of Emission	Lens Type	Viewing Angle
CSB63CR2GT2C	InGaAlP/InGaN	Red/Green	Water Clear	130°



ChromeLED Corp. reserves the right to make changes at any time in order to supply the best product possible. The most current version of this document will always be available at: [www.chromeled.com](http://www.chromeled.com)

**ABSOLUTE MAXIMUM RATINGS**
**(TA=25°C)**

Parameter	Symbol	Color	Max Rating	Unit
Power Dissipation	PD	RED	72	mW
		GREEN	80	
Pulse Current Forward Current	IFP	RED	90	mA
		GREEN	100	
Continuous Forward Current	IF	RED	30	mA
		GREEN	20	
Reverse Voltage	VR	5		V
Operating Temperature Range	TOPR	-20~+80		°C
Storage Temperature Range	TSTG	-30~+100		°C
IFP = Pulse Width ≤ 10 ms, Duty Ratio ≤1/10. Soldering Condition: 260 °C/ 5sec				

**OPTICAL-ELECTRICAL CHARACTERISTICS**
**(TA=25°C)**

Parameter	Symbol	Test Condition	Color	Value			Unit
				Min	Typ	Max	
Luminous Intensity	IV	IF = 20mA	Red	32	80	-	mcd
			Green	200	500	-	
Forward Voltage	VF	IF = 20mA	RED	-	2.0	2.4	V
			Green	-	3.0	3.6	
Reverse Leakage Current	IR	VR = 5V	RED	-	-	10	µA
			Green	-	-	10	
Viewing Angle	2θ1/2	IF = 20mA	RED	-	130	-	deg
			Green	-	130	-	
Dominant Wavelength	λD	IF = 20mA	RED	-	630	-	nm
			Green	-	525	-	

\*Tolerance of viewing angle: -10 / +5 deg.



ChromeLED Corp. reserves the right to make changes at any time in order to supply the best product possible. The most current version of this document will always be available at: [www.chromeled.com](http://www.chromeled.com)

## OPTICAL CHARACTERISTIC CURVES (RED)

Fig.1 Forward current vs. Forward Voltage

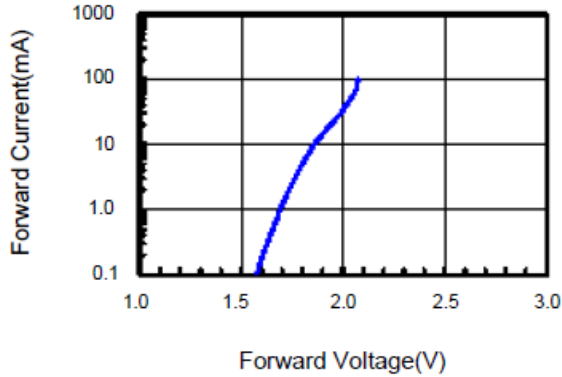

Fig.2 Relative Intensity vs. Forward Current

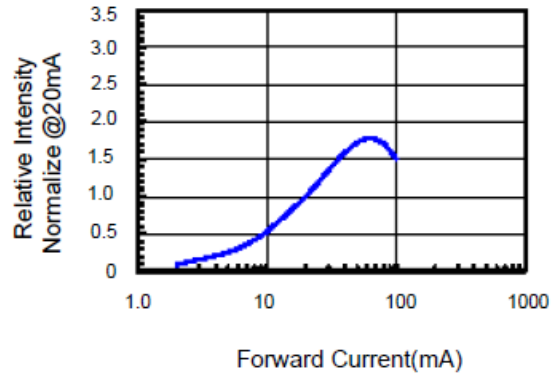

Fig.3 Forward Voltage vs. Temperature

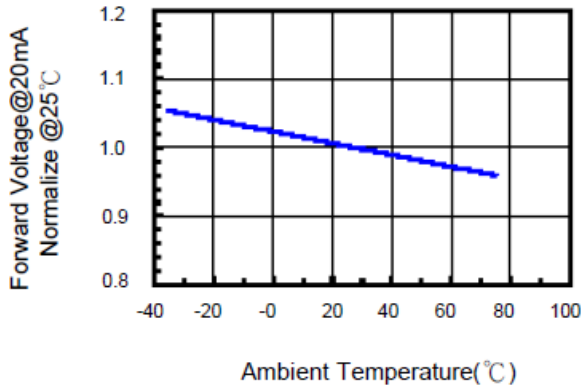

Fig.4 Relative Intensity vs. Temperature

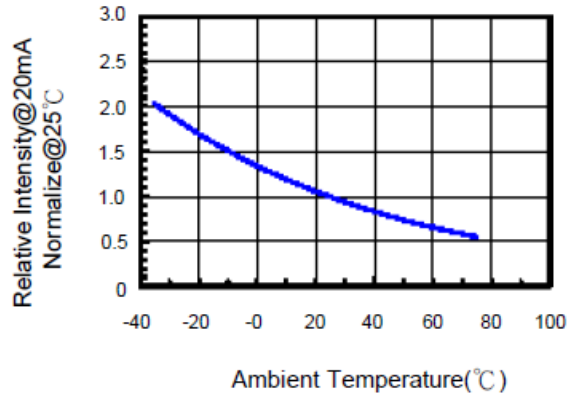

Fig.5 Relative Intensity vs. Wavelength

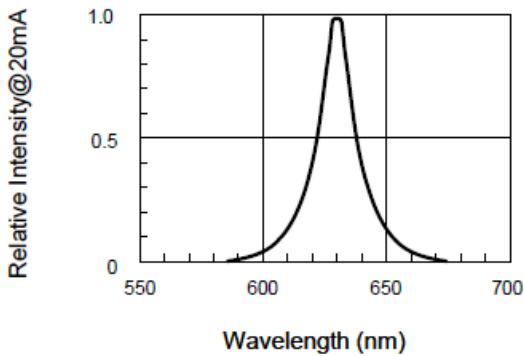
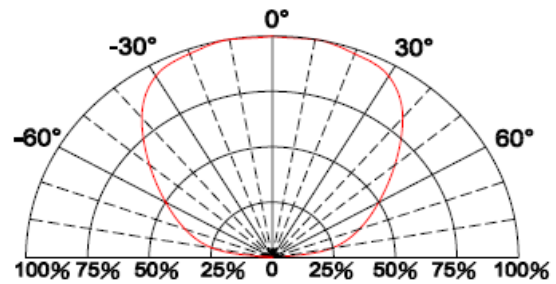

Fig.6 Directive Radiation



ChromeLED Corp. reserves the right to make changes at any time in order to supply the best product possible. The most current version of this document will always be available at: [www.chromeled.com](http://www.chromeled.com)

## OPTICAL CHARACTERISTIC CURVES (GREEN)

Fig.1 Forward current vs. Forward Voltage

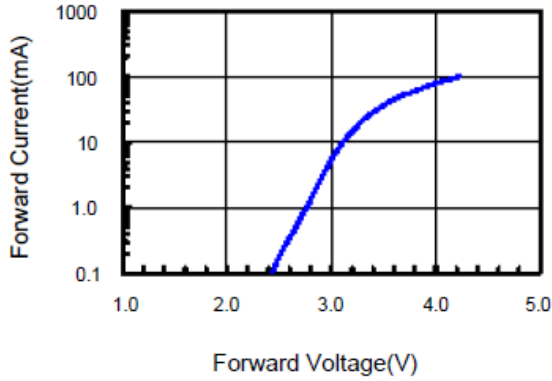

Fig.2 Relative Intensity vs. Forward Current

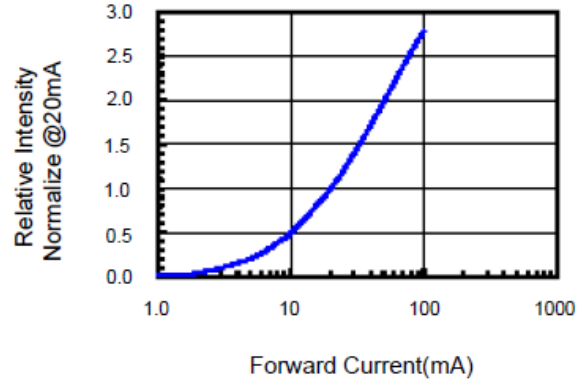

Fig.3 Forward Voltage vs. Temperature

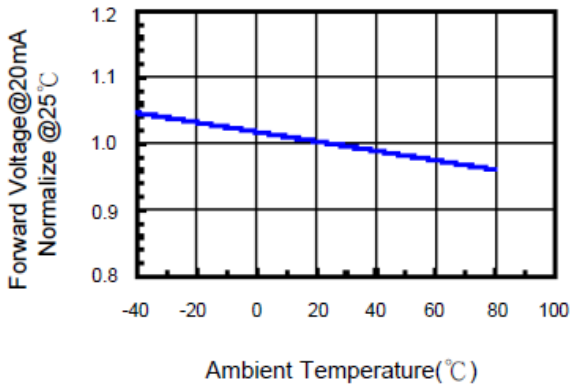

Fig.4 Relative Intensity vs. Temperature

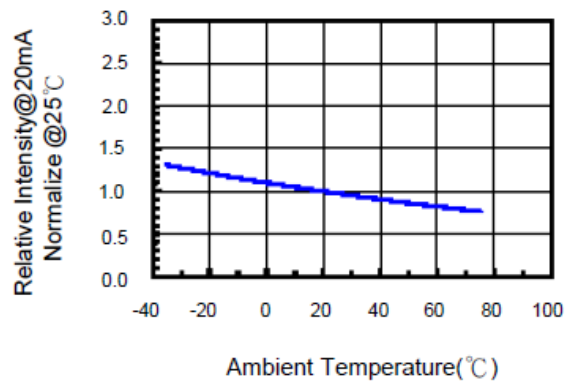

Fig.5 Relative Intensity vs. Wavelength

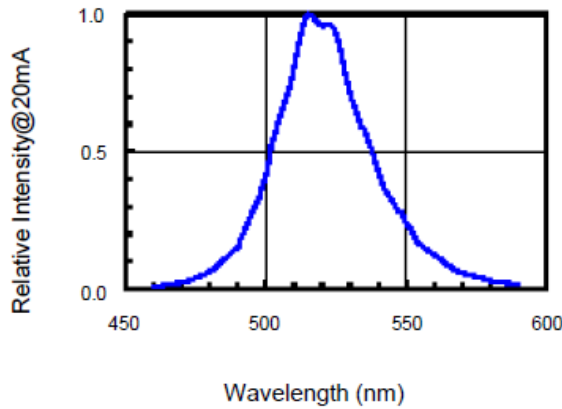
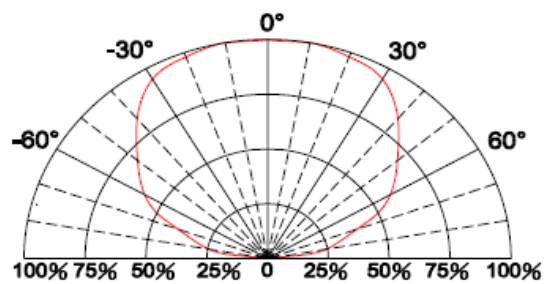

Fig.6 Directive Radiation



ChromeLED Corp. reserves the right to make changes at any time in order to supply the best product possible. The most current version of this document will always be available at: [www.chromeled.com](http://www.chromeled.com)

**SOLDERING CONDITIONS – LAMP TYPE LED**

1. Hand Solder

Basic spec is  $\leq 280^{\circ}\text{C}$  3 sec one time only.

2. Wave Solder

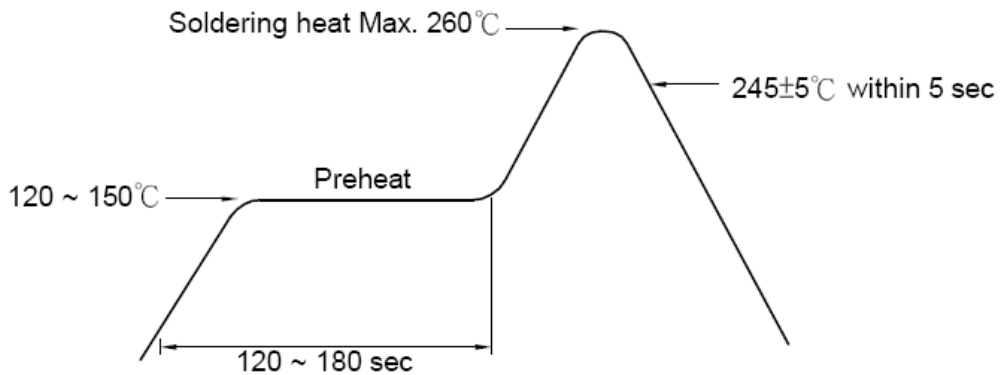

1. PB-Free Reflow Solder

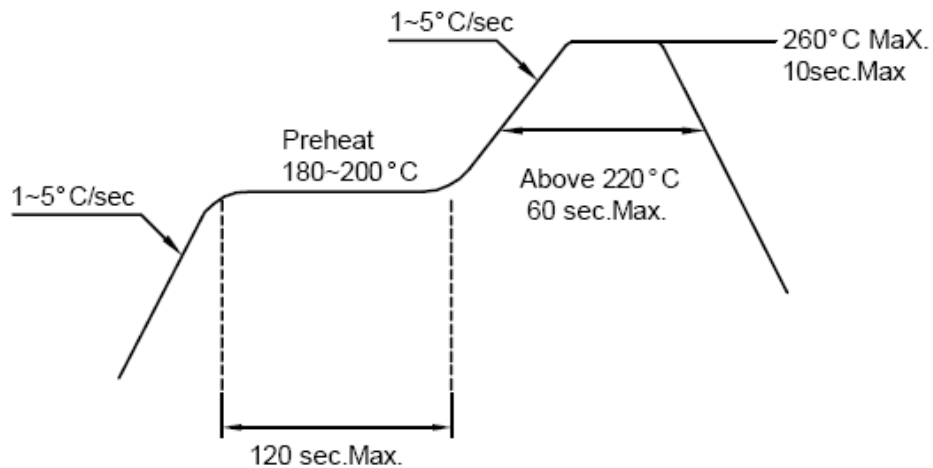

ChromeLED Corp. reserves the right to make changes at any time in order to supply the best product possible. The most current version of this document will always be available at: [www.chromeled.com](http://www.chromeled.com)

# PACKAGING SPECIFICATIONS

## CARRIER TAPE DIMENSION

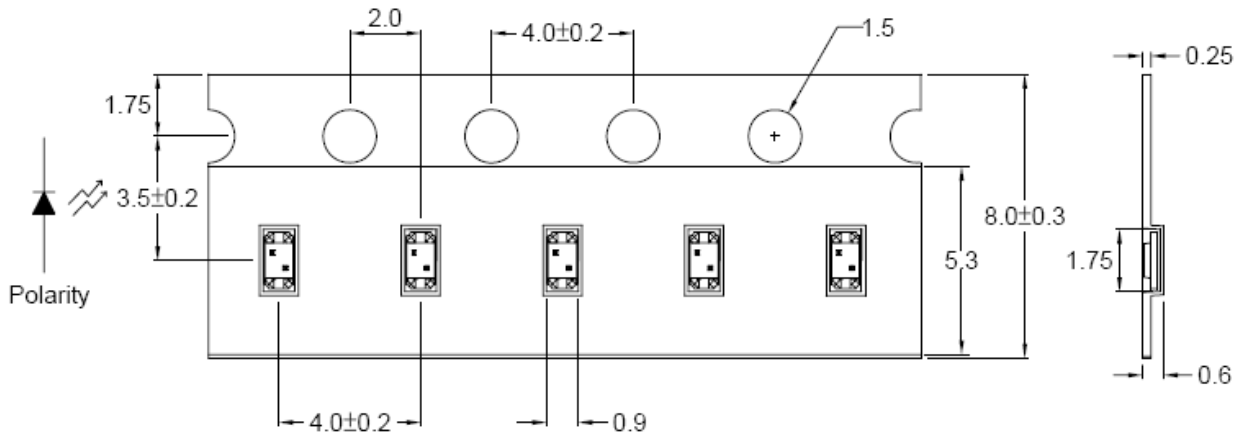

Note: The tolerances unless mentioned are ±0.1mm, Angle ±0.5; Unit=mm

## REEL DIMENSIONS

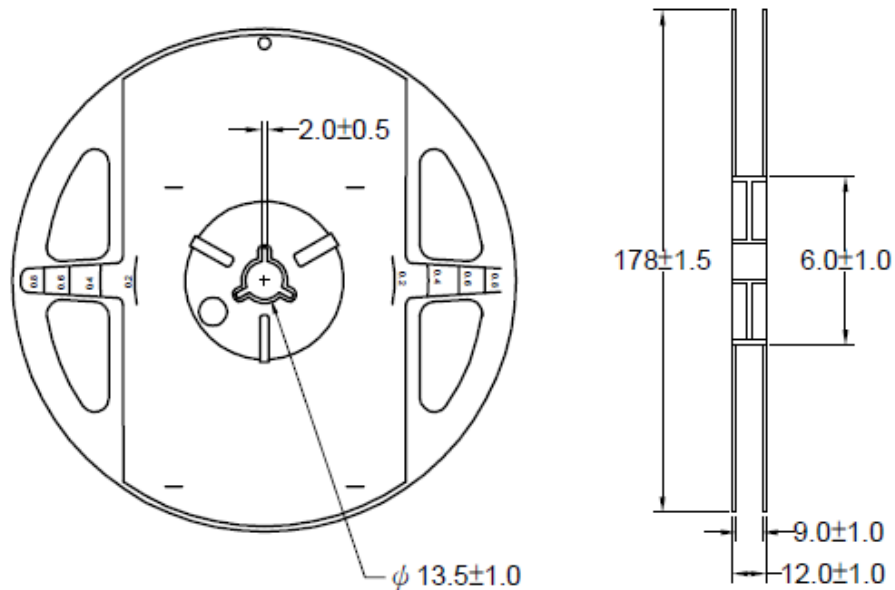

Notes:

1. 4000 pieces per reel.



ChromeLED Corp. reserves the right to make changes at any time in order to supply the best product possible. The most current version of this document will always be available at: [www.chromeled.com](http://www.chromeled.com)