

26 GHz Surface Mount Bandpass Filter

B259MC1S

DESCRIPTION

One of DLI's surface mount catalog bandpass filters designed for the 5G band. This filter utilizes DLI's low loss temperature stable materials which offer small size and minimal performance variation over temperature.

DLI's catalog BPF's are offered in a variety of frequency bands, which offers a drop-in solution with highly repeatable performance.

FEATURES

- Small Size
- Shielded Component
- Surface Mount Package
- Moisture Sensitivity Level: MSL1
- Frequency Stable over Temperature
- Operating & Storage Temp: -55°C to +125°C
- 50Ω Characteristic Impedance

Packaging and Ordering information:

To request Tape and Reel packaging, please order part number B259MC1S-T

SPECIFICATIONS*

Parameter	Frequency Range (GHz)	Min	Typ.	Max
Insertion Loss (dB)	24.25 - 27.5	—	2.9	4.0
Return Loss (dB)		10	15	—
Low Side Rejection (dB)	DC - 6.0	50	65	—
	6.0 - 16.0	40	60	—
	16.0 - 20.0	35	50	—
	20.0 - 23.0	30	35	—
High Side Rejection (dB)	28.5 - 29.5	20	30	—
	29.5 - 33.5	30	50	—
	33.5 - 36.0	40	60	—
	36.0 - 41.0	30	35	—
Size (L x W x H)	0.2165 x 0.09 x 0.07 in 5.5 x 2.3 x 1.8 mm			

*Electrical specifications at room temperature. Insertion loss shall vary up to ±0.5 dB over temperature.

26 GHz Surface Mount Bandpass Filter

B259MC1S

RF Measured Performance

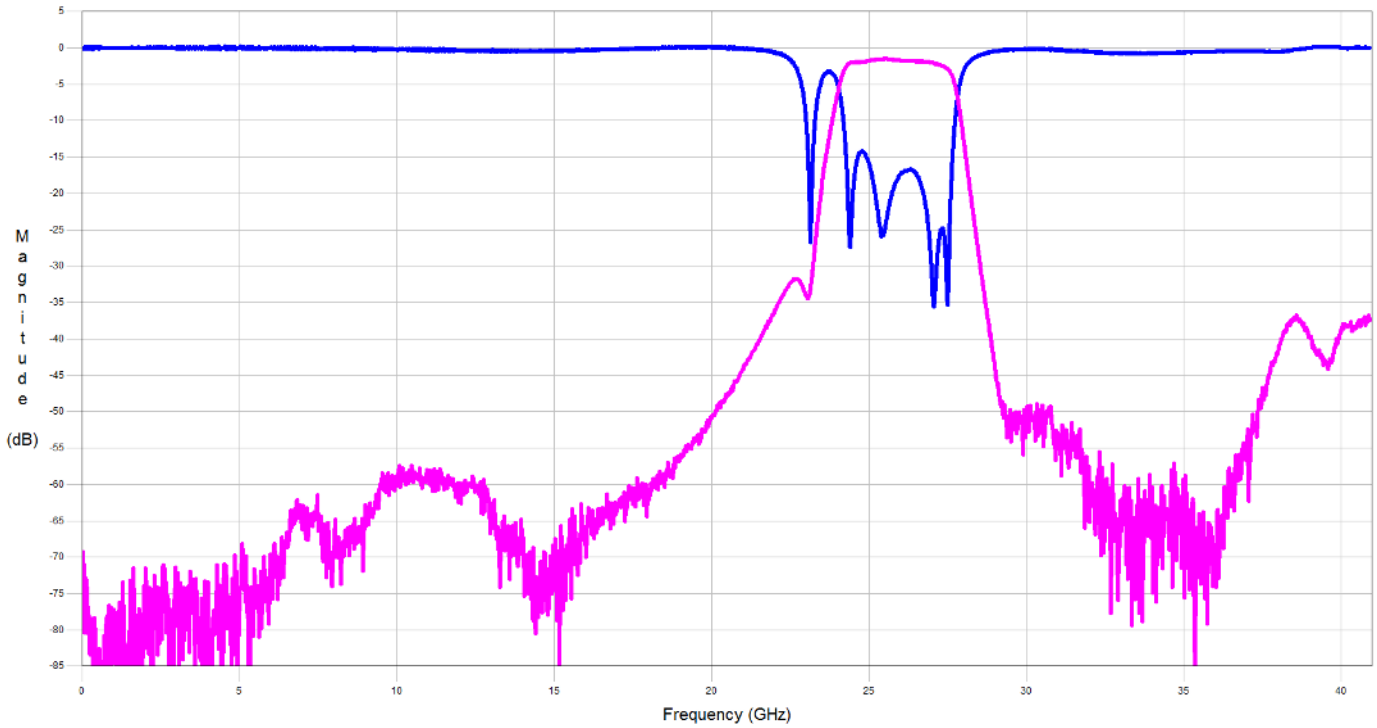

26 GHz Surface Mount Bandpass Filter

B259MC1S

Physical Dimensions

Units = inches (in)

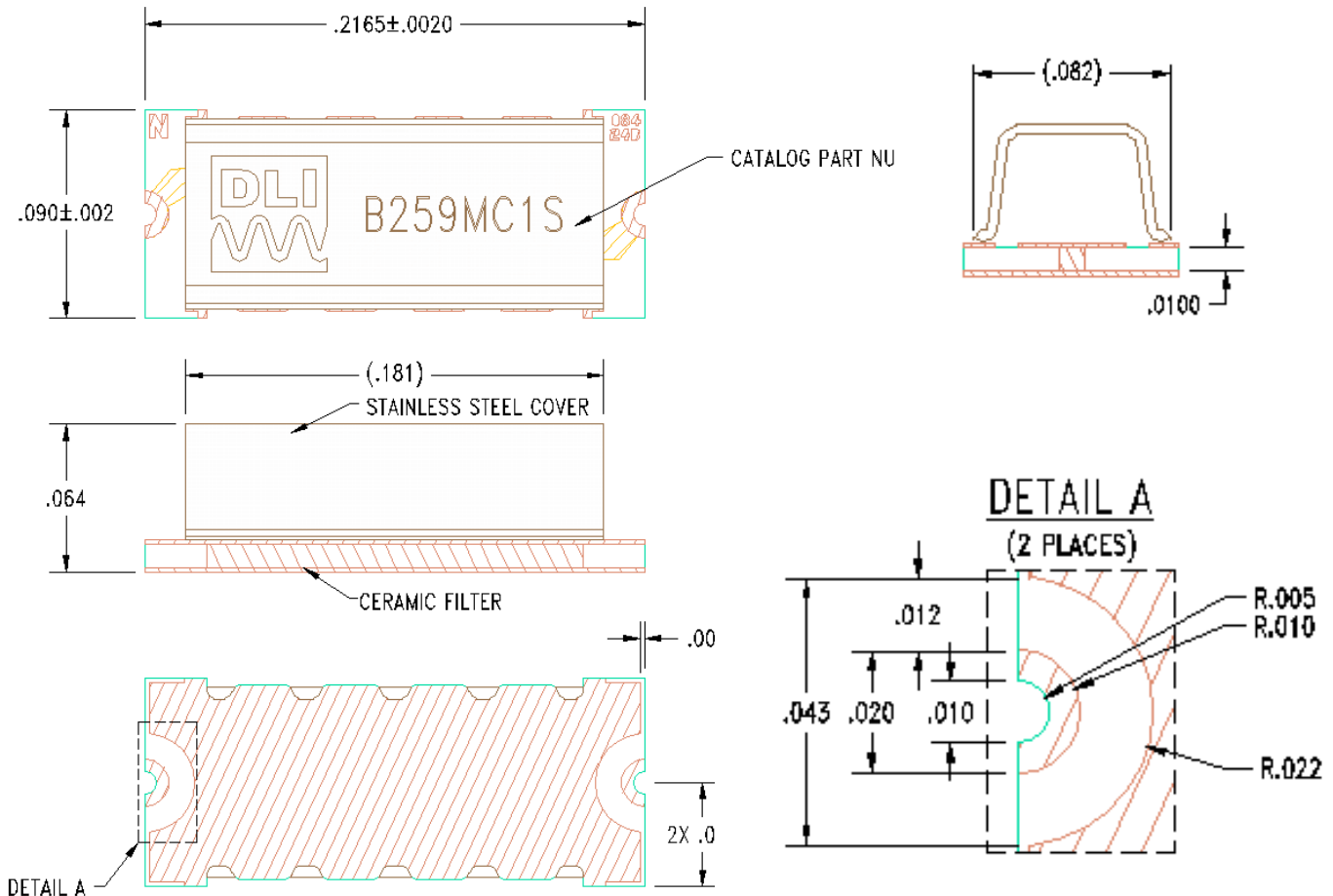

MAXIMUM ASSEMBLY PROCESS TEMPERATURE: 250°C

- 50Ω trace dimensions are application specific.
- Ensure adequate grounding beneath the part.



26 GHz Surface Mount Bandpass Filter

B259MC1S

PCB Pattern Recommendations

Unit : mil

