



Representative photograph, actual product appearance may vary.

Due to regional agency approval requirements, some products may not be available in your area. Please contact your regional Honeywell office regarding your product of choice.

590SX1N56S502SP

590 Series Commercial Potentiometer, Conductive Plastic Element, PC Terminals, 0.5 W Power Rating, 5 kOhm Resistance Value

Features

- Compact - 12,7 mm [0.5 in] modular size
- Robust - Brass shaft and bushings
- Conductive plastic element
- Linear taper
- PC style terminals

Typical Applications

- Manual controls
- Welding and heating
- Telecommunications

Description

The 590 Series is a low cost potentiometer with the benefits of a conductive plastic element. It offers a 1/2 watt power rating and a metal shaft and bushing.

590SX1N56S502SP

590 Series Commercial Potentiometer, Conductive Plastic Element, PC Terminals, 0.5 W Power Rating, 5 kOhm Resistance Value

Product Specifications

Potentiometer Type	Commercial
Element Type	Conductive Plastic
Terminal Type	PC
Power Rating	0.5 W
Resistance Value	5 kOhm
Resistance Tolerance	± 10 %
Linearity	± 5 %
Bushing Thread	6,35 mm [0.25 in] x 32 NEF-2A
Bushing length	6,35 mm [0.25 in]
Bushing Type	Standard
Shaft Diameter	3,18 mm [0.125 in]
Shaft length	22,22 mm [0.875 in]
Shaft Ending	Slotted
Body	12.7 mm [0.5 in] square, ± 0.79 mm [0.031 in]
Electrical Taper	Linear
Operating Temperature	-40 °C to 120 °C [-40 °F to 248 °F]
Working Voltage (Max.)	350 V
Rotational Life	50000 cycles
Mechanical Rotation	295°
Availability	Global
Series Name	590 Series
UNSPSC Code	4111363300
UNSPSC Commodity	4111363300 Potentiometers

Honeywell

590SX1N56S502SP

590 Series Commercial Potentiometer, Conductive Plastic Element, PC Terminals, 0.5 W Power Rating, 5 kOhm Resistance Value

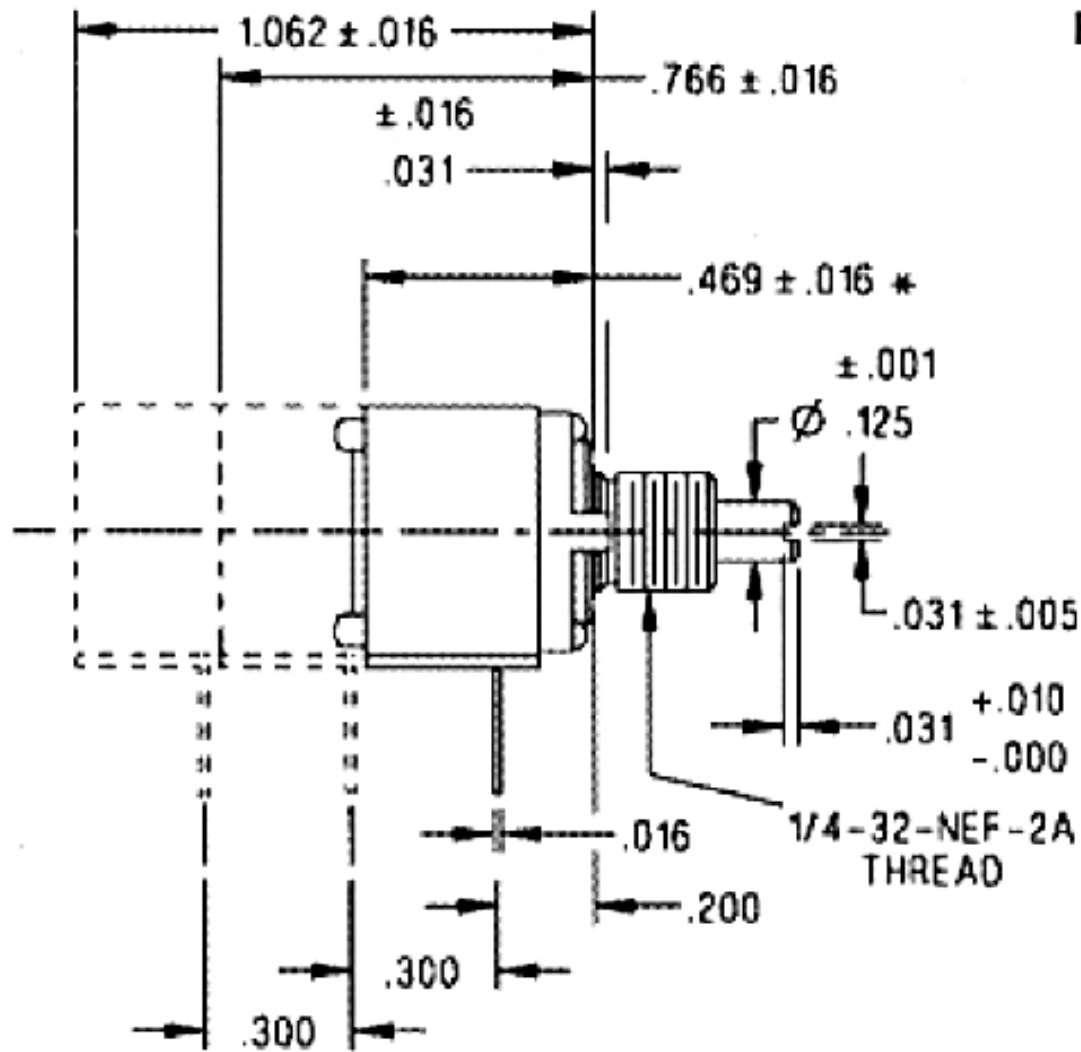

For Reference Only

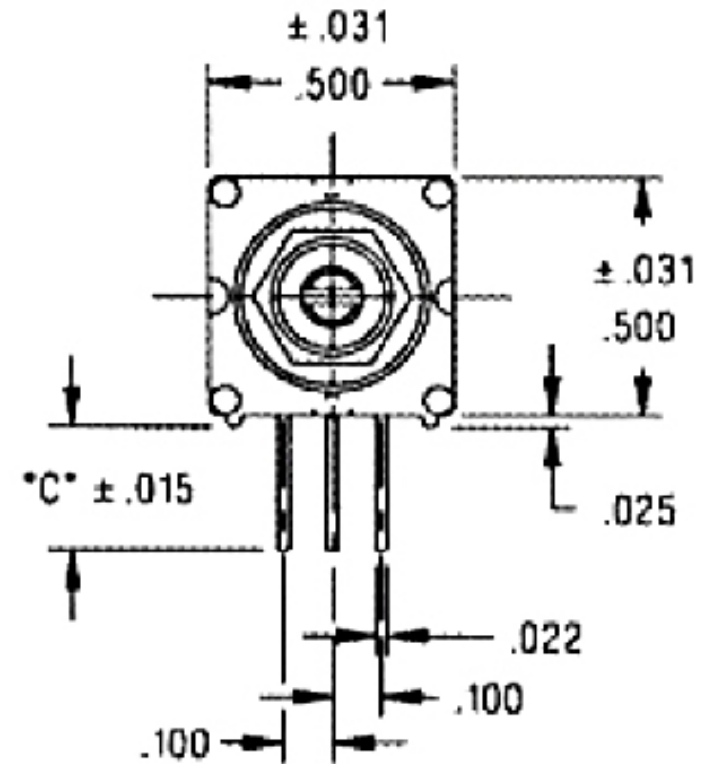

Honeywell

590SX1N56S502SP

590 Series Commercial Potentiometer, Conductive Plastic Element, PC Terminals, 0.5 W Power Rating, 5 kOhm Resistance Value

 WARNING

PERSONAL INJURY

DO NOT USE these products as safety or emergency stop devices, or in any other application where failure of the product could result in personal injury.

Failure to comply with these instructions could result in death or serious injury.

 WARNING

MISUSE OF DOCUMENTATION

- The information presented in this product sheet (or catalog) is for reference only. DO NOT USE this document as product installation information.
- Complete installation, operation and maintenance information is provided in the instructions supplied with each product.

Failure to comply with these instructions could result in death or serious injury.