

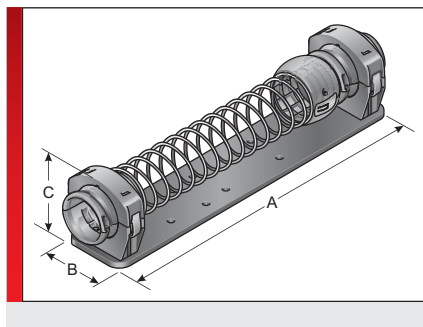







## M25/M32 recirculation system



### PRODUCT INFORMATION

### SPECIFICATIONS

-  Mod. polyamide PA 6  
base plate Aluminium  
Spring Steel
-  -40 – 110 °C
-  V0

Type	Order No.	Colour	A mm	B mm	C mm	Pack qty.
EWX 29 - 20N recirculation system	83692724	Black	290.00	72.50	70.00	1

Suitable for

 Mod. polyamide PA 6  
base plate Aluminium  
Spring Steel

 **Temperature / temperature range**  
-40 – 110 °C

 **Fire classification**  
V0

 **ROBI approval**

 **Halogen-free**

## M25/M32 recirculation system

RoHS

**RoHS (EC Directive 2002/95/EC)**

Made in  
Germany

**Made in Germany**

All details given in our sales material prospectuses and catalogues as well as the information available online are based on our current knowledge of the products described.

The electronic data and files made available by Murrplastik, particularly CAD files are based on our current knowledge of the product described.

A legally binding assurance of certain properties or the suitability for a certain purpose can not be determined from this information.

All information with respect to the chemical and physical properties of Murrplastik products as well as application advice given verbally, in writing or by tests, is given to the best of our knowledge.

This does not free the purchaser of carrying out their own inspections and tests in order to determine the suitability of a product for a specific purpose.

Murrplastik accepts no responsibility for the available information being up-to-date, correct or complete. Neither do we accept responsibility for the quality of this information.

Murrplastik accepts no liability for damage caused as a result of using our products.

Murrplastik reserves the right to make technical changes and improvements through constant further development of products and services.

Our General Terms and Conditions apply.

© Murrplastik Systemtechnik GmbH • prvlD\_89987~20160930~890283~83692724