

## SBS 1.1-COMPLIANT GAS GAUGE ENABLED WITH IMPEDANCE TRACK™ TECHNOLOGY FOR USE WITH THE bq29312A

### FEATURES

- Patented Impedance Track™ Technology Accurately Measures Available Charge in Li-Ion and Li-Polymer Batteries
- Better than 1% Error Over Lifetime of the Battery
- Instant Accuracy – No Learning Cycle Required
- Supports the Smart Battery Specification SBS V1.1
- Works With the TI bq29312A Analog Front-End (AFE) Protection IC to Provide Complete Pack Electronics Solution
- Full Array of Programmable Voltage, Current, and Temperature Protection Features
- Integrated Time Base Removes Need for External Crystal with Optional Crystal Input
- Electronics for 7.2-V, 10.8-V or 14.4-V Battery Packs With Few External Components
- Based on a Powerful Low-Power RISC CPU Core With High-Performance Peripherals
- Integrated Field Programmable FLASH Memory Eliminates the Need for External Configuration Memory
- Measures Charge Flow Using a High-Resolution, 16-Bit Integrating Delta-Sigma Converter
  - Better Than 0.65-nVh of Resolution
  - Self-Calibrating
  - Offset Error Less Than 1- $\mu$ V
- Uses 16-Bit Delta-Sigma Converter for Accurate Voltage and Temperature Measurements
- Extensive Data Reporting Options For Improved System Interaction
- Optional Pulse Charging Feature for Improved Charge Times
- Drives 3-, 4- or 5-Segment LED Display for Remaining Capacity Indication

- 38-Pin TSSOP (DBT)

### APPLICATIONS

- Notebook PCs
- Medical and Test Equipment
- Portable Instrumentation

### DESCRIPTION

The bq20z80 SBS-compliant gas gauge IC, incorporating patented Impedance Track technology, is designed for battery-pack or in-system installation. The bq20z80 measures and maintains an accurate record of available charge in Li-ion or Li-polymer batteries using its integrated high-performance analog peripherals. The bq20z80 monitors capacity change, battery impedance, open-circuit voltage, and other critical parameters of the battery pack, and reports the information to the system host controller over a serial-communication bus. It is designed to work with the bq29312A analog front-end (AFE) protection IC to maximize functionality and safety, and minimize component count and cost in smart battery circuits.

The Impedance Track technology continuously analyzes the battery impedance, resulting in superior gas-gauging accuracy. This enables remaining capacity to be calculated with discharge rate, temperature, and cell aging all accounted for during each stage of every cycle.

### AVAILABLE OPTIONS

T <sub>A</sub>	PACKAGE	
	38-PIN TSSOP (DBT) Tube	38-PIN TSSOP (DBT) Tape & Reel
-40°C to 85°C	bq20z80DBT-V101 <sup>(1)</sup>	bq20z80DBTR-V101 <sup>(2)</sup>

- (1) A single tube quantity is 50 units.  
 (2) A single reel quantity is 2000 units



Please be aware that an important notice concerning availability, standard warranty, and use in critical applications of Texas Instruments semiconductor products and disclaimers thereto appears at the end of this data sheet.

IMPEDANCE TRACK is a trademark of Texas Instruments.



These devices have limited built-in ESD protection. The leads should be shorted together or the device placed in conductive foam during storage or handling to prevent electrostatic damage to the MOS gates.

**TSSOP (DBT)  
(TOP VIEW)**

VIN	1	38	VSSD
TS1	2	37	NC
TS2	3	36	NC
PU	4	35	CLKOUT
PRES	5	34	XCK1 / VSSA
SCLK	6	33	XCK2 / ROSC
SAFE	7	32	FILT
VDDD	8	31	VDDA
RBI	9	30	VSSA
SDATA	10	29	VSSA
VSSD	11	28	SR1
SAFE	12	27	SR2
NC	13	26	MRST
NC	14	25	XALERT
SMBC	15	24	LED1
SMBD	16	23	LED2
DISP	17	22	LED3
PFIN	18	21	LED4
VSSD	19	20	LED5

NC - No internal connection

**TERMINAL FUNCTIONS**

TERMINAL NO.	NAME	I/O <sup>(1)</sup>	DESCRIPTION
1	VIN	I	Voltage measurement input from the AFE
2	TS1	I	1 <sup>st</sup> Thermistor voltage input connection to monitor temperature
3	TS2	I	2 <sup>nd</sup> Thermistor voltage input connection to monitor temperature
4	PU	O	Output to pull up the PRES pin for system detection
5	PRES	I	Active low input to sense system insertion and typically requires additional ESD protection
6	SCLK	I/OD	Communication clock to the AFE
7	SAFE	O	Active high output to enforce additional level of safety protection; e.g., fuse blow. (Inverse of pin 12)
8	VDDD	P	Positive supply for digital circuitry and I/O pins
9	RBI	P	Backup power to the bq20z80 data registers during periods of low operating voltage. RBI accepts a storage capacitor or a battery input.
10	SDATA	I/O	Data transfer to and from the AFE
12	SAFE	O	Active low output to enforce additional level of safety protection; e.g., fuse blow. (Inverse of pin 7)
13	NC	–	Not used— leave floating
14	NC	–	Not used— leave floating
15	SMBC	I/OD	SMBus clock open-drain bidirectional pin used to clock the data transfer to and from the bq20z80
16	SMBD	I/OD	SMBus data open-drain bidirectional pin used to transfer address and data to and from the bq20z80
17	DISP	I	Display control for the LEDs. This pin is typically connected to bq29312A REG via a 100-kΩ resistor and a push-button switch to VSSD.
18	PFIN	I	Active low input to detect secondary protector output status and allows the bq20z80 to report the status of the 2 <sup>nd</sup> level protection output
20	LED5	O	LED5 display segment that drives an external LED depending on the firmware configuration
21	LED4	O	LED4 display segment that drives an external LED depending on the firmware configuration

(1) I = Input, IA = Analog input, I/O = Input/output, I/OD = Input/Open-drain output, O = Output, OA = Analog output, P = Power

**TERMINAL FUNCTIONS (continued)**

TERMINAL		I/O <sup>(1)</sup>	DESCRIPTION
NO.	NAME		
22	LED3	O	LED3 display segment that drives an external LED depending on the firmware configuration
23	LED2	O	LED2 display segment that drives an external LED depending on the firmware configuration
24	LED1	O	LED1 display segment that drives an external LED depending on the firmware configuration
25	XALERT	I	Input from bq29312A XALERT output.
26	MRST	I	Master reset input that forces the device into reset when held high
27	SR2	IA	Connections for a small-value sense resistor to monitor the battery charge- and discharge-current flow
28	SR1	IA	Connections for a small-value sense resistor to monitor the battery charge- and discharge-current flow
31	VDDA	P	Positive supply for analog circuitry
32	FILT	IA	Analog input connected to the external PLL filter components which are a 150-pF capacitor to V <sub>SSA</sub> , in parallel with a 61.9-kΩ resistor and a 2200-pF capacitor in series. Place these components as close as possible to the bq20z80 to ensure optimal performance.
33	XCK2/ROSC	O	32.768-kHz crystal oscillator output pin or connected to a 100k, 50ppm or better resistor if the internal oscillator is used
34	XCK1/VSSA	I	32.768-kHz crystal oscillator input pin or connected to VSSA if the internal oscillator is used
35	CLKOUT	O	32.768-kHz output for the bq29312. This pin should be directly connected to the AFE.
36	NC	-	Not used— leave floating
37	NC	-	Not used— leave floating
11, 19, 38	VSSD	P	Negative supply for digital circuitry
29, 30	VSSA	P	Negative supply for analog circuitry.

**ABSOLUTE MAXIMUM RATINGS**

 over operating free-air temperature range (unless otherwise noted)<sup>(1)</sup>

		RANGE
V <sub>DDA</sub> and V <sub>DD</sub> relative to V <sub>SS</sub> <sup>(2)</sup>	Supply voltage range	–0.3 V to 4.1 V
V <sub>(I/O)</sub> relative to V <sub>SS</sub> <sup>(2)</sup>	Open-drain I/O pins	–0.3 V to 6 V
V <sub>I</sub> relative to V <sub>SS</sub> <sup>(2)</sup>	Input voltage range to all other pins	–0.3 V to VDDA + 0.3 V
T <sub>A</sub>	Operating free-air temperature range	–40°C to 85°C
T <sub>stg</sub>	Storage temperature range	–65°C to 150°C

(1) Stresses beyond those listed under absolute maximum ratings may cause permanent damage to the device. These are stress ratings only, and functional operation of the device at these or any other conditions beyond those indicated under recommended operating conditions is not implied. Exposure to absolute-maximum-rated conditions for extended periods may affect device reliability.

(2) V<sub>SS</sub> refers to the common node of V<sub>(SSA)</sub> and V<sub>(SSD)</sub>.

### ELECTRICAL CHARACTERISTICS

$V_{DD} = 3\text{ V to }3.6\text{ V}$ ,  $T_A = -40^\circ\text{C to }85^\circ\text{C}$  (unless otherwise noted)

PARAMETER	TEST CONDITIONS	MIN	TYP	MAX	UNIT	
$V_{DD}$ Supply voltage	VDDA and VDDD	3	3.3	3.6	V	
$I_{DD}$ Operating mode current	No flash programming		350 <sup>(1)</sup>		$\mu\text{A}$	
$I_{(SLP)}$ Low-power storage mode current	Sleep mode		8 <sup>(1)</sup>		$\mu\text{A}$	
$V_{OL}$ Output voltage low SMBC, SMBD, SDATA, SCLK, SAFE, SAFE, PU	$I_{OL} = 0.5\text{ mA}$			0.4	V	
LED1 – LED5	$I_{OL} = 10\text{ mA}$			0.4		
$V_{OH}$ Output high voltage, SMBC, SMBD, SDATA, SCLK, SAFE, SAFE, PU	$I_{OH} = -1\text{ mA}$	$V_{DD} - 0.5$				
$V_{IL}$ Input voltage low SMBC, SMBD, SDATA, SCLK, XALERT, PRES, PFIN		-0.3		0.8		
DISP		-0.3		0.8		
$V_{IH}$ Input voltage high SMBC, SMBD, SDATA, SCLK, XALERT, PRES, PFIN		2		6		
DISP		2	$V_{CC} + 0.3$			
$C_{IN}$ Input capacitance			5			pF
$V_{(AI1)}$ Input voltage range VIN, TS1, TS2		$V_{SS} - 0.3$		1		V
$V_{(AI2)}$ Input voltage range SR1, SR2		$V_{SS} - 0.25$		0.25		
$Z_{(AI1)}$ Input impedance SR1, SR2	0 V–1 V	2.5			M $\Omega$	
$Z_{(AI2)}$ Input impedance VIN, TS1, TS2	0 V–1 V	8			M $\Omega$	

(1) This value does not include the bq29312

### POWER-ON RESET

$V_{DD} = 3\text{ V to }3.6\text{ V}$ ,  $T_A = -40^\circ\text{C to }85^\circ\text{C}$  (unless otherwise noted)

PARAMETER	TEST CONDITIONS	MIN	TYP	MAX	UNIT
$V_{IT-}$ Negative-going voltage input		2.1	2.3	2.5	V
$V_{HYS}$ Power-on reset hysteresis		50	150	200	mV

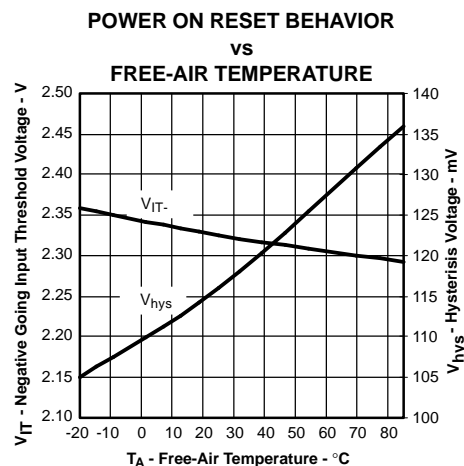

### INTEGRATING ADC (Coulomb Counter) CHARACTERISTICS

$V_{DD} = 3\text{ V to }3.6\text{ V}$ ,  $T_A = -40^\circ\text{C to }85^\circ\text{C}$  (unless otherwise noted)

PARAMETER	TEST CONDITIONS	MIN	TYP	MAX	UNIT
$V_{(SR)}$ Input voltage range, $V_{(SR2)}$ and $V_{(SR1)}$	$V_{(SR)} = V_{(SR2)} - V_{(SR1)}$	-0.25		0.25	V
$V_{(SROS)}$ Input offset			1		$\mu\text{V}$
INL Integral nonlinearity error			0.004%	0.019%	

## PLL SWITCHING CHARACTERISTICS

 $V_{DD} = 3\text{ V to }3.6\text{ V}$ ,  $T_A = -40^\circ\text{C to }85^\circ\text{C}$  (unless otherwise noted)

PARAMETER		TEST CONDITIONS	MIN	TYP	MAX	UNIT
$t_{(SP)}$	Start-up time <sup>(1)</sup>	0.5% frequency error		2	5	ms

(1) The frequency error is measured from the trimmed frequency of the internal system clock which is 128 oscillator frequency, nominally 4.194 MHz.

## OSCILLATOR

 $V_{DD} = 3\text{ V to }3.6\text{ V}$ ,  $T_A = -40^\circ\text{C to }85^\circ\text{C}$  (unless otherwise noted)

PARAMETER		TEST CONDITIONS	MIN	TYP	MAX	UNIT
$f_{(EXO)}$	Frequency error from 32.768 kHz	ROSC = 100 k $\Omega$	-2%	0.25%	2%	
		ROSC = 100 k $\Omega$ , $V_{DD} = 3.3\text{ V}$	-1%	0.25%	1%	
		XCK1 = 12-pF XTAL	-0.25%		0.25%	
$f_{(SXO)}$	Start-up time <sup>(1)</sup>	ROSC = 100 k $\Omega$			250	$\mu\text{s}$
		XCK1 = 12-pF XTAL			200	ms

(1) The start-up time is defined as the time it takes for the oscillator output frequency to be within 1% of the specified frequency.

## DATA FLASH MEMORY CHARACTERISTICS

 $V_{DD} = 3\text{ V to }3.6\text{ V}$ ,  $T_A = -40^\circ\text{C to }85^\circ\text{C}$  (unless otherwise noted)

PARAMETER		TEST CONDITIONS	MIN	TYP	MAX	UNIT
$t_{DR}$	Data retention		<sup>(1)</sup> 10			Years
	Flash programming write-cycles	<sup>(1)</sup>	20,000			Cycles
$t_{(WORDPROG)}$	Word programming time	<sup>(1)</sup>			2	ms
$I_{(DDPROG)}$	Flash-write supply current	<sup>(1)</sup>		8	15	mA

(1) Assured by design. Not production tested

## REGISTER BACKUP

 $V_{DD} = 3\text{ V to }3.6\text{ V}$ ,  $T_A = -40^\circ\text{C to }85^\circ\text{C}$  (unless otherwise noted)

PARAMETER		TEST CONDITIONS	MIN	TYP	MAX	UNIT
$I_{(RBI)}$	RBI data-retention input current	$V_{(RBI)} > 3\text{ V}$ , $V_{DD} < V_{IT}$		10	100	nA
$V_{(RBI)}$	RBI data-retention voltage <sup>(1)</sup>		1.3			V

(1) Specified by design. Not production tested.

### SMBus TIMING SPECIFICATIONS

$V_{DD} = 3\text{ V to }3.6\text{ V}$ ,  $T_A = -40^\circ\text{C to }85^\circ\text{C}$  (unless otherwise noted)

PARAMETER		TEST CONDITIONS	MIN	TYP	MAX	UNIT
$f_{SMB}$	SMBus operating frequency	Slave mode, SMBC 50% duty cycle	10		100	kHz
$f_{MAS}$	SMBus master clock frequency	Master mode, no clock low slave extend		51.2		
$t_{BUF}$	Bus free time between start and stop		4.7			$\mu\text{s}$
$t_{HD:STA}$	Hold time after (repeated) start		4			
$t_{SU:STA}$	Repeated start setup time		4.7			
$t_{SU:STO}$	Stop setup time		4			
$t_{HD:DAT}$	Data hold time	Receive mode	0			ns
		Transmit mode	300			
$t_{SU:DAT}$	Data setup time		250			ms
$t_{TIMEOUT}$	Error signal/detect		(1)25		35	
$t_{LOW}$	Clock low period		4.7			$\mu\text{s}$
$t_{HIGH}$	Clock high period		(2)4		50	ms
$t_{LOW:SEXT}$	Cumulative clock low slave extend time				(3)25	
$t_{LOW:MEXT}$	Cumulative clock low master extend time				(4)10	
$t_F$	Clock/data fall time	$(V_{ILMAX} - 0.15\text{ V})$ to $(V_{IHMIN} + 0.15\text{ V})$			300	ns
$t_R$	Clock/data rise time	$0.9\text{ VDD}$ to $(V_{ILMAX} - 0.15\text{ V})$			1000	

- (1) The bq20z80 times out when any clock low exceeds  $t_{TIMEOUT}$ .
- (2)  $t_{HIGH:MAX}$  is minimum bus idle time. SMBC = 1 for  $t > 50\ \mu\text{s}$  causes reset of any transaction involving the bq20z80 that is in progress.
- (3)  $t_{LOW:SEXT}$  is the cumulative time a slave device is allowed to extend the clock cycles in one message from initial start to the stop.
- (4)  $t_{LOW:MEXT}$  is the cumulative time a master device is allowed to extend the clock cycles in one message from initial start to the stop.

#### SMBus TIMING DIAGRAM

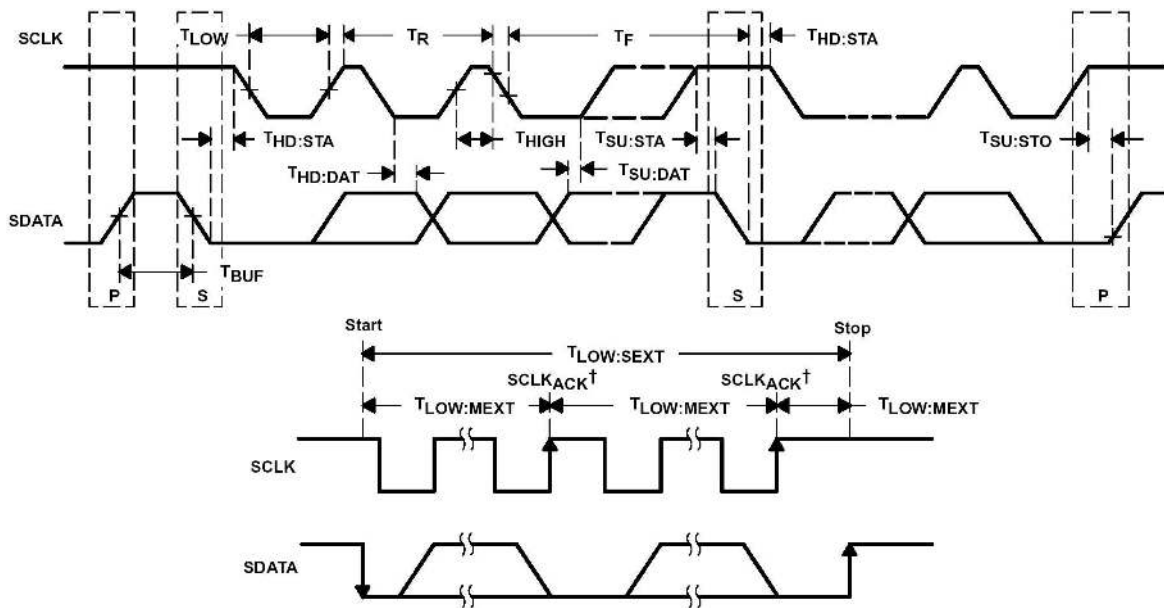

<sup>†</sup>SCLK<sub>ACK</sub> is the acknowledge-related clock pulse generated by the master.

## FUNCTIONAL DESCRIPTION

Within the functional description of the bq20z80 System Management Bus (SMBus), commands are prefixed with *SBS.* and data flash variables are prefixed with *DF:* and are both italicized in full. For example: *SBS.RemainingCapacity()* and *DF:Fast Charge Current*.

### OSCILLATOR FUNCTION

The oscillator of the bq20z80 can be set up for internal or external operation. On power up, the bq20z80 automatically attempts to start the internal oscillator. If a 100-k $\Omega$  resistor is not connected to ROSC (pin 33), then it attempts to start the oscillator using an external 32.768-kHz crystal.

#### NOTE:

Install either the 100-k $\Omega$  ROSC resistor *or* the 12-pF, 32.768-kHz crystal. Do not install both.

The performance of the internal oscillator depends on the tolerance of the 100-k $\Omega$  resistor between RSOC (pin 33) and VSSA (pin 34). Choose a resistor with a tolerance of  $\pm 0.1\%$ , and 50-ppm or better temperature drift. Place this resistor as close as possible to the bq20z80. If a 12-pF crystal is used, place it as close as possible to the XCK1 (pin 34) and XCK2 (pin 33) pins. If not properly implemented, the PCB layout in this area can degrade oscillator performance.

### SYSTEM PRESENT OPERATION

The bq20z80 periodically (1 s) pulls the PU output high. Connect this pin to the  $\overline{\text{PRES}}$  pin of the bq20z80 via a resistor of approximately 5 k $\Omega$ . The bq20z80 measures the  $\overline{\text{PRES}}$  input during the PU-active period to determine its state.

The bq20z80 detects that the battery is present in the system via a low state on the  $\overline{\text{PRES}}$  input. When this occurs, the bq20z80 enters normal operating mode and sets the PRES bit in *SBS.OperationStatus()*. When the pack is removed from the system and the  $\overline{\text{PRES}}$  input is high, the bq20z80 enters the battery-removed state, disabling the charge and discharge FETs, and enabling the 0-V/precharging FET. If *DF:Operation Cfg B [NR]* is set, the  $\overline{\text{PRES}}$  input is ignored and can be left floating.

NAME	CLASS / SUBCLASS	FORMAT	VALID RANGE	SIZE (BYTES)	UNITS	DEFAULT VALUE
Operation Cfg B	Configuration / Registers (64)	Hex	0x0000 to 0xffff	2	N/A	0x6140

### GENERAL OPERATION

The bq20z80 determines battery capacity by monitoring individual cell voltages and the amount of charge input or removed from a rechargeable battery. In addition, the bq20z80 measures individual cell voltages, pack voltage, temperature, and current using features of the bq29312A analog front end (AFE) device and calculates individual cell impedances using collected data.

The bq20z80 measures charge/discharge activity by monitoring the voltage across a small-value series sense resistor (5 m $\Omega$  to 20 m $\Omega$  typ.) between the cell stack negative terminal and the negative terminal of the battery pack. When an applications load is applied, impedance of each cell is measured by comparing its Open Circuit Voltage (OCV) obtained for the present state of charge using a predefined OCV(SOC) function with measured voltage under load.

The bq20z80 interfaces with the bq29312A to perform battery protection, cell balancing, and voltage translation functions. The bq20z80 can accept inputs of up to two identical NTC thermistors (default is Semitec 103AT) for temperature measurement, or can also be configured to use its internal temperature sensor. The bq20z80 uses temperature to monitor the battery-pack environment.

### BATTERY PARAMETER MEASUREMENTS

The bq20z80 uses an integrating delta-sigma analog-to-digital converter (ADC) for current measurement, and a second delta-sigma ADC for individual cell and battery voltage, and temperature measurement. The individual cell and pack voltages, *SBS.CellVoltage()*, *SBS.Voltage()*, *SBS.Current()*, *SBS.AverageCurrent()*, and *SBS.Temperature()* are updated at 1-second intervals during normal operation.

## Charge and Discharge Counting

The integrating delta-sigma ADC measures the charge/discharge flow of the battery by measuring the voltage drop across a small-value sense resistor between the SR1 and SR2 pins. The integrating ADC measures bipolar signals from -0.25 V to 0.25 V. The bq20z80 detects charge activity when  $V_{SR} = V_{(SR1)} - V_{(SR2)}$  is positive and discharge activity when  $V_{SR} = V_{(SR1)} - V_{(SR2)}$  is negative. The bq20z80 continuously integrates the signal over time, using an internal counter. The fundamental rate of the counter is 0.65 nVh.

## Coulomb Counter Dead Band

The bq20z80 does not accumulate charge or discharge for gas gauging when the current input is below the dead-band current threshold. The threshold is programmed in *DF:CC Deadband* (Coulomb Counter Deadband) and should be set sufficiently high to prevent false signal detection with no charge or discharge flowing through the sense resistor.

NAME	CLASS / SUBCLASS	FORMAT	VALID RANGE	SIZE (BYTES)	UNITS	DEFAULT VALUE
CC Deadband	Calibration / Current (107)	Integer	0 to 255	1	294nV	34

## Voltage

The bq20z80 updates the individual series cell voltages through the bq29312A at one-second intervals. In Sleep mode the period changes from 1 s to *DF:Sleep Voltage Time*. The bq20z80 configures the bq29312A to connect the selected cell, cell offset, or bq29312A VREF to the CELL pin of the bq29312, which is required to be connected to VIN of the bq20z80. The internal ADC of the bq20z80 measures the voltage, scales and calibrates it appropriately, then reports the *SBS.Voltage()* and the individual cell voltages in *SBS.CellVoltage1()*, *SBS.CellVoltage2()*, *SBS.CellVoltage3()*, and *SBS.CellVoltage4()*. This data is also used to calculate the impedance of the cell for the Impedance Track gas-gauging when *SBS.Current()* is above 100 mA and  $dV/dt$  is  $< 1 \mu V/s$ .

## Current

The bq20z80 uses the SR1 and SR2 inputs to measure and calculate the battery charge and discharge current. This value is reported via *SBS.Current()* and is updated at one-second intervals in normal mode, and at intervals defined by *DF:Sleep Current Time* in sleep mode. *SBS.AverageCurrent()* is implemented as a single-pole infinite-impulse response (IIR) filter with a 14.5 s time constant using *SBS.Current()* data and is also updated once per second.

NAME	CLASS / SUBCLASS	FORMAT	VALID RANGE	SIZE (BYTES)	UNITS	DEFAULT VALUE
Sleep Current Time	Power / Power (68)	Integer	0 to 255	1	s	20

## Auto Calibration

The bq20z80 provides an auto-calibration feature to cancel the voltage offset error across SR1 and SR2 for maximum charge measurement accuracy. The bq20z80 performs auto-calibration when the SMBus lines stay low continuously for a minimum of 5 s and *SBS.Temperature()* is within bounds of *DF:Cal Inhibit Temp Low* and *DF:Cal Inhibit Temp High*. The bq20z80 is capable of automatic offset calibration down to 1  $\mu V$ .

NAME	CLASS / SUBCLASS	FORMAT	VALID RANGE	SIZE (BYTES)	UNITS	DEFAULT VALUE
Cal Inhibit Temp Low	Power / Power (68)	Signed Int	-400 to 1200	2	0.1°C	50
Cal Inhibit Temp High						450

## Temperature

The bq20z80 TS1 and TS2 inputs, in conjunction with two identical NTC thermistors (default are Semitec 103AT), measure the battery environmental temperature. The bq20z80 can also be configured to use its internal temperature sensor. The bq20z80 updates the reported temperature each second in normal mode, and each *DF:Sleep Voltage Time* in Sleep mode, via *SBS.Temperature()* depending on the state of *DF:Operation Cfg A [TEMP1, TEMPO]*.

NAME	CLASS / SUBCLASS	FORMAT	VALID RANGE	SIZE (BYTES)	UNITS	DEFAULT VALUE
Sleep Voltage Time	Power / Power (68)	Integer	0 to 100	1	s	5
Operation Cfg A	Configuration / Registers (64)	Hex	0x0000 to 0xffff	2	N/A	0x0f29



## Gas Gauging

The bq20z80 measures individual cell voltages, pack voltage, temperature, and current using features of the bq29312A AFE device. The bq20z80 determines battery state of charge by analyzing individual cell voltages when a time exceeding 35 minutes has passed since the batteries last charge or discharge activity. The bq20z80 measures charge and discharge activity by monitoring the voltage across a small-value series sense resistor (5 mΩ to 20 mΩ typ.) between the cell stack negative terminal and the negative terminal of the battery pack. The batteries State of charge is subsequently adjusted during load or charger application using the integrated charge passed through the battery.

Resistance update takes place in discharge mode, while OCV and Qmax updates take place only in relaxation mode. Entry and exit of each mode is controlled by ata flash (DF:) parameters in the subclass 'Gas Gauging: Current Thresholds' section. Charge mode is exited and Relaxation mode is entered when *SBS.Current()* goes below *DF:Quit Current* for a period of *DF:Chg Relax Time*. Discharge mode is entered when *SBS.Current()* goes below *DF:Dsg Current Threshold*. Discharge mode is exited and Relaxation mode is entered when *SBS.Current()* goes above (–) *DF:Quit Current* threshold for a period of *DF:Dsg Relax Time*. Charge mode is entered when *SBS.Current()* goes above *DF:Chg Current Threshold*.

The total battery capacity is found by comparing states of charge before and after applying the load with the amount of charge passed. When an applications load is applied, the impedance of each cell is measured by comparing the open circuit voltage (OCV) obtained from a predefined function for present state of charge with the measured voltage under load.

Measurements of OCV and charge integration determine chemical state of charge and *Chemical Capacity* (*Qmax*). The initial *DF:Qmax Pack*, *DF:Qmax Cell 1*, *DF:Qmax Cell 2*, *DF:Qmax Cell 3*, and *DF:Qmax Cell 4* values are taken from the cell manufacturers' data sheet multiplied by the number of parallel cells, and are also used for the *SBS.DesignCapacity()* value in *DF:Design Capacity*. The bq20z80 acquires and updates the battery-impedance profile during normal battery usage. It uses this profile, along with state-of-charge and the *Qmax* values, to determine *SBS.FullChargeCapacity()* and *SBS.RelativeStateOfCharge()* specifically for the present load and temperature. *SBS.FullChargeCapacity()* is reported as capacity or energy available from a fully charged battery under the present load and temperature until *SBS.Voltage()* reaches the *DF:Term Voltage*.

NAME	CLASS / SUBCLASS	FORMAT	VALID RANGE	SIZE (BYTES)	UNITS	DEFAULT VALUE
Term Voltage	Gas Gauging / IT Config (80)	Signed Int	-32768 to 32767	2	mV	12000
Quit Current	Gas Gauging / Current Thresholds (81)	Integer	0 to 1000	2	mA	10
Dsg Relax Time			0 to 255	1	s	1
Chg Relax Time			0 to 255	1	s	60
Chg Current Threshold			0 to 2000	2	mA	50
Dsg Current Threshold			0 to 2000	2	mA	100
QMax Pack	Gas Gauging / State (82)	Integer	0 to 65535	2	mAh	4400
Qmax Cell 1			0 to 65535	2	mAh	4400
Qmax Cell 2			0 to 65535	2	mAh	4400
Qmax Cell 3			0 to 65535	2	mAh	4400
Qmax Cell 4			0 to 65535	2	mAh	4400
Design Capacity	SBS Configuration / Data (48)		0 to 65535	2	mAh	4400

## Impedance Track™ Load Model

During normal operation, the battery-impedance profile compensation of the Impedance Track algorithm can provide more accurate full-charge and remaining state-of-charge information if the typical load type is known. The two selectable options are constant current and constant power.

<i>DF:Load Mode</i> VALUE	COMPENSATION
0x00	Constant current
0x01	Constant power

## Impedance Track Load Compensation

In order to compensate for the I x R drop near the end of discharge, the bq20z80 needs to be configured for whatever current (or power) will flow in the future. While it can not be exactly known, the bq20z80 can use load history such as the averaged current of the present discharge to make a sufficiently accurate prediction. The

bq20z80 can be configured to use several methods of this prediction shown in Table 1, by setting the DF:Load Select value. Because this estimate has only a second-order effect on remaining capacity accuracy, different measurement based methods (0x00 to 0x03) result in only minor differences in accuracy. However, methods 0x04-0x06 where an estimate is arbitrarily assigned by the user can result in significant error if a fixed estimate is far from the actual load.

**Table 1. Impedance Track Load-Compensation Settings**

DF:Load Select	Load Mode	Load Compensation
0x00	Constant Current	Previous Discharge Average Current in <i>DF:Avg I Last Run</i>
	Constant Power	Previous Discharge Average Power in <i>DF:Avg P Last Run</i>
0x01	Constant Current	Present Discharge Average Current
	Constant Power	Present Discharge Average Power
0x02	Constant Current	<i>SBS.Current( )</i>
	Constant Power	<i>RAM.InstantPower( ) = SBS.Current( ) x SBS.Voltage( )</i>
0x03	Constant Current	<i>SBS.AverageCurrent( )</i>
	Constant Power	<i>SBS.AveragePower( ) = SBS.AverageCurrent( ) x SBS.Voltage( )</i>
0x04	Constant Current	<i>SBS.DesignCapacity( ) / 5</i>
	Constant Power	<i>SBS.DesignEnergy( ) / 5</i>
0x05	Constant Current	<i>SBS.AtRate( )</i> (mAh)
	Constant Power	<i>SBS.AtRate( )</i> (10mWh)
0x06	Constant Current	<i>DF:User Rate-mA</i>
	Constant Power	<i>DF:User Rate-10mWh</i>

NAME	CLASS / SUBCLASS	FORMAT	VALID RANGE	SIZE (BYTES)	UNITS	DEFAULT VALUE
User Rate-mAh	Gas Gauging / IT Config (80)	Signed Int	2000 to 9000	2	mAh	0
User Rate-10 mWh	Gas Gauging / IT Config (80)		3000 to 14000	2	10 mWh	0

**Pulsed Load Compensation**

In order to take into account pulsed loads, while calculating remaining capacity until *DF:Term Voltage* is reached, bq20z80 monitors not only average load but also short load spikes. The maximum voltage deviation during a load spike is continuously updated during discharge and stored in *DF:Delta Voltage*.

NAME	CLASS / SUBCLASS	FORMAT	VALID RANGE	SIZE (BYTES)	UNITS	DEFAULT VALUE
Delta Voltage	Gas Gauging / State (82)	Integer	-32767 to 32768	2	mV	0

**Reserve Battery Capacity**

The bq20z80 allows an amount of capacity to be reserved in either mAh (*DF:Reserve Cap-mAh*) or 10 mWh (*DF:Reserve Cap-10mWh*) units between the point where *SBS.RemainingCapacity( )* is reported as 0%, and the absolute minimum voltage, *DF:Term Voltage*. This enables a system to report zero energy, but still have enough reserve energy to perform a controlled shutdown, or to provide an extended sleep period for the host system.

Also, if *DF:Operation Cfg B [ResCap] = 0*, the reserve capacity is compensated at a no-load conditions. However, if *DF:Operation Cfg B [ResCap] = 1*, then the reserve capacity is compensated at the present discharge rate as selected by *DF:Load Select*.

NAME	CLASS / SUBCLASS	FORMAT	VALID RANGE	SIZE (BYTES)	UNITS	DEFAULT VALUE
Reserve Cap-mAh	Gas Gauging / IT Config (80)	Signed Int	0 to 9000	2	mAh	0
Reserve Cap-10 mWh			0 to 14000	2	10 mWh	0

**QMAX Update Conditions**

The bq20z80 updates the no-load full capacity (QMAX) when two open circuit voltage (OCV) readings are taken when the battery is in a relaxed state before and after charge or discharge activity. A relaxed state is achieved if the battery voltage has a dV/dt of < 4µV. Typically it takes 2 hrs in a charged state and 5 hrs in a discharged state to ensure that the dV/dt condition is satisfied. If 5 hrs is exceeded, a reading will be taken even if the dV/dt condition was not satisfied. This update is disqualified under the following conditions:

**Temperature** If *SBS.Temperature( )* is outside of the range 10°C to 40°C

**Delta Capacity** If the capacity change between suitable battery rest periods is less than 37%

**Voltage** If and *SBS.CellVoltage1..4( )* is within the range of 3737mV and 3800mV

### Discharge and Charge Alarms

The bq20z80 enables *SBS.BatteryStatus( )* [TDA, FD, TCA, FC] flags to be set or cleared on the following thresholds based on *SBS.RelativeStateOfCharge( )*.

<i>DF:Operation Cfg A</i>		CONDITION	<i>SBS.BatteryStatus( )</i> FLAG ACTION
<i>[DMODE] = 0</i>	<i>[DMODE] = 1</i>		
<i>SBS.RelativeStateOfCharge( )</i>	<i>SBS.AbsoluteOfCharge( )</i>	$\leq DF:TDA \text{ Set } \%$	<i>Terminate_Discharge_Alarm</i> is set
		$\geq DF:TDA \text{ Clear } \%$	<i>Terminate_discharge_Alarm</i> is cleared
		$\leq DF:FD \text{ Set } \%$	<i>Fully_Discharged</i> is set
		$\geq DF:FD \text{ Clear } \%$	<i>Fully_Discharged</i> is cleared
		$\geq DF:TCA \text{ Set } \%$	<i>Terminate_Charge_Alarm</i> is set
		$\leq DF:TCA \text{ Clear } \%$	<i>Terminate_Charge_Alarm</i> is cleared
		$\geq DF:FC \text{ Set } \%$	<i>Fully_Charged</i> is set
		$\leq DF:FC \text{ Clear } \%$	<i>Fully_Charged</i> is cleared

The *SBS.RelativeStateOfCharge( )* or *SBS.AbsoluteStateOfCharge( )* based thresholds can be disabled by setting the value to -1%.

The *SBS.BatteryStatus( )* [TDA, FD] flags can also be set or cleared based on the level of *SBS.Voltage( )*. If the voltage settings are not used then they should be set to extreme range values.

	CONDITION	<i>SBS.BatteryStatus( )</i> FLAG ACTION
<i>SBS.Voltage( )</i>	$\leq DF:TDA \text{ Volt Threshold}$ for a period of <i>DF:TDA Volt Time</i>	<i>Terminate_Discharge_Alarm</i> is set
	$\geq DF:TDA \text{ Recovery}$	<i>Terminate_discharge_Alarm</i> is cleared
	$\leq DF:FD \text{ Volt Threshold}$ for a period of <i>DF:FD Volt Time</i>	<i>Fully_Discharged</i> is set
	$\geq DF:FD \text{ Recovery}$	<i>Fully_Discharged</i> is cleared

See the Charge Termination and Protection sections of this data sheet for further details on the setting of *Terminate\_Charge\_Alarm*.

NAME	CLASS / SUBCLASS	FORMAT	VALID RANGE	SIZE (BYTES)	UNITS	DEFAULT VALUE
TDA Set % <sup>(1)</sup>	SBS Configuration / Config (49)	Integer	-1 to 100	1	%	6
TDA Clear% <sup>(1)</sup>						8
FD Set % <sup>(1)</sup>						2
FD Clear % <sup>(1)</sup>						5
TCA Set % <sup>(1)</sup>						-1
TCA Clear % <sup>(1)</sup>						95
FC Set % <sup>(1)</sup>						-1
FC Clear % <sup>(1)</sup>						98
TDA Volt Threshold		Integer	0 to 16000	2	mV	5000
TDA Volt Time			0 to 60	1	s	5
TDA Recovery			0 to 16000	2	mV	5500
FD Volt Threshold			0 to 16000	2	mV	5000
FD Volt Time			0 to 60	1	s	5
FD Recovery			0 to 16000	2	mV	5000

(1) Setting to -1% prevents the TDA, TCA, FD, or FC flag from being set or cleared based on state of charge.

## 1st LEVEL PROTECTION FEATURES

The bq20z80 supports a wide range of battery and system protection features that are easily configured or disabled via the integrated data flash.

### Cell Overvoltage

The bq20z80 can disable charging by turning off the charge FET if any cell voltage is  $\geq DF:COV\ Threshold$  for a  $\geq DF:COV\ Time$ . This feature is disabled if  $DF:COV\ Time = 0$ .

During the time between when an excessive voltage is first detected and the expiration of  $DF:COV\ Time$ ,  $SBS.SafetyAlert( ) [COV]$  is set. If, during this period, the voltage falls below the  $DF:COV\ Threshold$ , this flag is cleared.

If  $DF:COV\ Time$  expires, the charge FET is turned off. The ZVCHG FET is also turned off if the  $DF:Operation\ Cfg\ A [ZVCHG1, ZVCHG0]$  bits are set appropriately. Also, when  $DF:COV\ Time$  expires,  $SBS.ChargingCurrent( )$  and  $SBS.ChargingVoltage( )$  are cleared,  $SBS.BatteryStatus( )\ Terminate\_Charge\_Alarm$  is set, and  $SBS.SafetyStatus( ) [COV]$  is set.

For the bq20z80 to fully recover from a cell overvoltage condition, all  $SBS.CellVoltage( )$  values must be  $\leq$  the  $DF:COV\ Recovery$  threshold. When this occurs, the charge FET is allowed to be turned on only if other safety and configuration states permit. On recovery from an overvoltage condition,  $SBS.BatteryStatus( )\ Terminate\_Charge\_Alarm$  is reset,  $SBS.ChargingCurrent( )$  and  $SBS.ChargingVoltage( )$  are set to the appropriate value per the charging algorithm, and  $SBS.SafetyStatus( ) [COV]$  is reset.

However, when the bq20z80 has  $SBS.SafetyStatus( ) [COV]$  set, the charge FET is turned on again while  $SBS.Current( )$  is reported to be  $\leq (-)\ DF:Dsg\ Current\ Threshold$ . No other flags change state until full recovery is reached. This prevents overheating the charge-FET body diode during discharge from an overvoltage condition.

NAME	CLASS / SUBCLASS	FORMAT	VALID RANGE	SIZE (BYTES)	UNITS	DEFAULT VALUE
COV Threshold	1st Level Safety / Voltage (0)	Integer	3700 to 5000	2	mV	4300
COV Recovery			0 to 4400	2		3900
COV Time			0 to 60	1	s	2

### Cell Overvoltage Threshold Compensation

If the bq20z80 detects charging ( $SBS.BatteryStatus( ) [DSG] = 0$ ) the actual threshold for cell-overvoltage detection may be reduced, based on the reported  $SBS.Temperature( )$ .

If  $SBS.Temperature( )$  is  $> DF:Over\ Temp\ Chg - DF:COV\ Temp\ Hys$ , the actual cell-overvoltage threshold used is  $DF:COV\ Threshold - DF:COV\ Delta$ . However, if  $DF:COV\ Delta = 0$  then the compensation of the cell-overvoltage threshold is disabled.

NAME	DESCRIPTION	FORMAT	VALID RANGE	SIZE (BYTES)	UNITS	DEFAULT VALUE
Overtmp Chg	1st Level Safety / Temperature (2)	Integer	0 to 1200	2	0.1°C	550
COV Temp Hys	1st Level Safety / Voltage (0)		0 to 250	1		100
COV Delta			0 to 200	1	mV	20

### Pack Overvoltage

The bq20z80 can disable charging by turning off the charge FET if  $SBS.Voltage( )$  is  $\geq DF:POV\ Threshold$  for a period  $\geq DF:POV\ Time$ . However, if  $DF:POV\ Time = 0$ , this feature is disabled.

During the period between when an excessive voltage is detected and the expiration of  $DF:POV\ Time$ , the  $SBS.SafetyAlert( ) [POV]$  bit is set. If during this period, the voltage falls below the  $DF:POV\ Threshold$ , this flag is cleared.

If  $DF:POV\ Time$  expires, the charge FET is turned off. The ZVCHG FET is also turned off if the  $DF:Operation\ Cfg\ A [ZVCHG1, ZVCHG0]$  bits are set appropriately. Also, when  $DF:POV\ Time$  expires,  $SBS.ChargingCurrent( )$  and  $SBS.ChargingVoltage( )$  are set to 0,  $SBS.BatteryStatus( )\ Terminate\_Charge\_Alarm$  is set, and  $SBS.SafetyStatus( ) [POV]$  is set.

For the bq20z80 to fully recover from a pack overvoltage condition, *SBS.Voltage()* must be  $\leq DF:POV$  Recovery threshold. When this occurs, the charge FET is allowed to be turned on only if other safety and configuration states permit. On recovery from a pack overvoltage condition, *SBS.BatteryStatus()* *Terminate\_Charge\_Alarm* is reset, *SBS.ChargingCurrent()* and *SBS.ChargingVoltage()* are set to the appropriate value per the charging algorithm, and *SBS.SafetyStatus()* [*POV*] is reset.

However, when the *SBS.SafetyStatus()* [*POV*] bit set, the charge FET is turned on again while *SBS.Current()* is reported to be  $\leq (-) DF:Dsg$  Current Threshold. No other flags change state until the full recovery is reached. This prevents overheating the charge-FET body diode during discharge from an overvoltage condition.

NAME	CLASS / SUBCLASS	FORMAT	VALID RANGE	SIZE (BYTES)	UNITS	DEFAULT VALUE
POV Threshold	1st Level Safety / Voltage (0)	Integer	0 to 18000	2	mV	17500
POV Recovery			0 to 17000	2		16000
POV Time			0 to 60	1	s	2

### Cell Undervoltage

The bq20z80 can disable discharging by turning off the discharge FET if any *SBS.CellVoltageX()* is  $\leq DF:CUV$  Threshold for a period  $\geq DF:CUV$  Time. This feature is disabled if *DF:CUV* Time = 0.

During the period between the time when a low voltage is first detected and the expiration of *DF:CUV* Time, the *SBS.SafetyAlert()* [*CUV*] bit is set. If, during this period, the voltage rises above *DF:CUV* Threshold, this flag is cleared.

If *DF:CUV* Time expires, the discharge FET is turned off and the ZVCHG FET is turned on if *DF:Operation Cfg A* [*ZVCGH1*, *ZVCHG0*] are set appropriately. Also, when *DF:CUV* Time expires, *SBS.BatteryStatus()* [*TDA*, *FD*] are set, *SBS.ChargingCurrent()* is set to *DF:Pre-Charge Current*, *SBS.OperationStatus()* [*XDSG*] is set and *SBS.SafetyStatus()* [*CUV*] is set.

For the bq20z80 to fully recover from a cell undervoltage condition, all *SBS.CellVoltageX()* values should be  $\geq DF:CUV$  Recovery threshold. When this occurs, the discharge FET is allowed to be turned on only if other safety and configuration states permit. On recovery from an undervoltage condition, *SBS.BatteryStatus()* [*TDA*] is reset, *SBS.ChargingCurrent()* and *SBS.ChargingVoltage()* are set to the appropriate value per the charging algorithm and *SBS.OperationStatus()* [*XDSG*] and *SBS.SafetyStatus()* [*CUV*] are reset.

However, when the bq20z80 has the *SBS.SafetyStatus()* [*CUV*] bit set, the discharge FET is turned on again if *SBS.Current()* is reported to be  $\geq DF:Chg$  Current Threshold. No other flags change state until full recovery is reached. This prevents overheating the discharge-FET body diode during charging from an undervoltage condition.

NAME	CLASS / SUBCLASS	FORMAT	VALID RANGE	SIZE (BYTES)	UNITS	DEFAULT VALUE
CUV Threshold	1st Level Safety / Voltage (0)	Integer	0 to 3500	2	mV	2200
CUV Recovery			0 to 3600	2		3000
CUV Time			0 to 60	1	s	2

### Pack Undervoltage

The bq20z80 can disable discharging by turning off the discharge FET if *SBS.Voltage()* is  $\leq DF:PUV$  Threshold for a time period  $\geq DF:PUV$  Time. This feature is disabled if *DF:PUV* Time = 0.

During the period between the time when a low voltage is first detected and the expiration of *DF:PUV* Time, *SBS.SafetyAlert()* [*PUV*] is set. If, during this period, the voltage rises above the *DF:PUV* Threshold, this flag is cleared.

If *DF:PUV* Time expires, the discharge FET is turned off and the ZVCHG FET is turned on if *DF:Operation Cfg A* [*ZVCHG1*, *ZVCHG0*] are set appropriately. Also when *DF:PUV* Time expires *SBS.BatteryStatus()* [*TDA*, *FD*] are set, *SBS.ChargingCurrent()* is set to *DF:Pre-Charge Current*, *SBS.OperationStatus()* [*XDSG*] is set and *SBS.SafetyStatus()* [*PUV*] is set.

For the bq20z80 to fully recover from a pack undervoltage condition, *SBS.Voltage( )* should be  $\geq DF:PUV$  Recovery threshold. When this occurs, the discharge FET is allowed to be turned on only if other safety and configuration states permit. On recovery from a pack undervoltage condition, *SBS.BatteryStatus( ) [TDA]* is reset, *SBS.ChargingCurrent( )* and *SBS.ChargingVoltage( )* are set to the appropriate value per the charging algorithm and *SBS.OperationStatus( ) [XDSG]* and *SBS.SafetyStatus( ) [PUV]* are reset.

However, when *SBS.SafetyStatus( ) [PUV]* is set, the discharge FET is turned on again, as long as *SBS.Current( )* is reported to be  $\geq DF:Chg$  Current Threshold. No other flags change state until full recovery is reached. This prevents overheating the discharge-FET body diode during charging from an undervoltage condition.

NAME	DESCRIPTION	FORMAT	VALID RANGE	SIZE (BYTES)	UNITS	DEFAULT VALUE
PUV Threshold	1st Level Safety / Voltage (0)	Integer	0 to 16000	2	mV	11000
PUV Recovery			0 to 16000	2		12000
PUV Time			0 to 60	1	s	2

### Charge and Discharge Overcurrent

The bq20z80 has two independent tiers (levels) of overcurrent protection for discharge and charge. These two tiers require the *SBS.Current( )* to be  $\geq$  a programmed threshold in either charge or discharge current for a period  $\geq$  a programmable time. If the programmable time for any of the current-protection levels is set to 0, that specific feature is disabled.

The bq29312A provides a third level of discharge overcurrent (overload) protection that reacts according to the bq29312A internal settings. The bq29312A discharge overcurrent is configured by the bq20z80, where *DF:AFE OC Dsg* (see bq29312A OLV register) and *DF:AFE OC Dsg Time* (see bq29312A OLT register) are used to provide the current threshold and delay timing. See the 'Overload Detection' section of the bq29312A data sheet for more details and the appropriate values to use.

For the first two tiers of overcurrent protection, during the period between when excessive current is detected and the expiration of the timer, the respective *SBS.SafetyAlert( )* bit is set. If the timer expires, or *SBS.Current( )* returns within normal operating parameters, the *SBS.SafetyAlert( )* bit is cleared.

	DF THRESHOLD	DF TIME	FET	SBS.SAFETYALERT( ), SBS.SAFETYSTATUS( ) AND DF:Nonremovable Cfg	DF CLEAR THRESHOLD
Tier-1 Charge	OC (1st Tier) Chg	OC (1st Tier) Chg Time	CHG	OCC	OC Chg Recovery
Tier-2 Charge	OC (2nd Tier) Chg	OC (2nd Tier) Chg Time	CHG	OCC2	
Tier-1 Discharge	OC (1st Tier) Dsg	OC (1st Tier) Dsg Time	DSG	OCD	OC Dsg Recovery
Tier-2 Discharge	OC (2nd Tier) Dsg	OC (2nd Tier) Dsg Time	DSG	OCD2	
Tier-3 Discharge	AFE OC Dsg	AFE OC Dsg Time	CHG, DSG	AOCD <sup>(1)</sup>	AFE OC DsgRecovery

(1) No *SBS.SafetyAlert( )* flag

If the timer of any tier expires during charging, the charge FET is turned off and the ZVCHG FET is turned off if the *DF:Operation Cfg A [ZVCHG1, ZVCHG0]* are set appropriately. When this occurs, the internal *AFE\_Current\_Fault* timer is started from 0, *SBS.ChargingCurrent( )* and *SBS.ChargingVoltage( )* are set to 0, *SBS.BatteryStatus( ) [TCA]* is set, and the appropriate tier flag is set in *SBS.SafetyStatus( )*.

However, when the bq20z80 has either of *SBS.SafetyStatus( ) [OCC, OCC2]* set, the charge FET is turned on again, as long as *SBS.Current( )* is reported to be  $\leq (-) DF:Dsg$  Current Threshold. No other flags change state until full recovery is reached. This prevents overheating the charge-FET body diode during discharge. This action is not affected by the state of *DF:Operation Cfg B [NR]*.

If the timer of either of the first two tiers expires during discharging, the discharge FET is turned off and the ZVCHG FET is turned on if *DF:Operation Cfg A [ZVCHG1, ZVCHG0]* are set appropriately. When this occurs the *AFE\_Current\_Fault* timer is started from 0, *SBS.ChargingCurrent( )* is set to *DF:Pre-Charge Current*, *SBS.OperationStatus( ) [XDSG]* is set, *SBS.BatteryStatus( ) [TDA]* is set, and the correct tier flag is set in *SBS.SafetyStatus( )*.

When the bq29312A detects a discharge-overcurrent fault, the charge and discharge FETs are turned off, the XALERT pin of the bq20z80 is driven low by the XALERT pin of the bq29312, and the bq29312A is interrogated. When the bq20z80 identifies the overcurrent condition, the *AFE\_Current\_Fault* timer is started from 0, *SBS.BatteryStatus( ) [TDA]* is set, *SBS.ChargingCurrent( )* is set to 0, and *SBS.SafetyStatus( ) [AOCD]* is set.

However, when the bq20z80 has any of *SBS.SafetyStatus( ) [OCD, OCD2, AOCD]* set, the FETs are turned on again, as long as *SBS.Current( )* is reported to be  $\leq (-)$  *DF:Dsg Current Threshold*. No other flags change state until full recovery is reached. This prevents overheating the charge-FET body diode during discharge. This action is not affected by the state of *DF:Operation Cfg B [NR]*.

The bq20z80 can individually configure each overcurrent-protection feature to recover via two different methods based on *DF:Operation Cfg B [NR]*.

**Standard Recovery**, where *DF:Operation Cfg B [NR] = 0*, and the overcurrent tier is not selected in *DF:Non-Removable Cfg*. When the pack is removed and reinserted the condition is cleared. Pack removal and reinsertion is detected by a low-to-high-to-low transition on the PRES input. When the tier is not selected in *DF:Non-Removable Cfg*, that particular feature uses the Non-Removable Battery Mode recovery.

**Nonremovable Battery Mode Recovery** where *DF:Operation Cfg B [NR] = 1*. The state of *DF:Non-Removable Cfg* has no consequence when *DF:Operation Cfg B [NR] = 1*. This recovery requires *SBS.AverageCurrent( )* to be  $\leq$  the respective recovery threshold, and for the *AFE\_Current\_Fault* timer  $\geq$  *DF:Current Recovery Time*.

When a charging-fault recovery condition is detected, then the charge FET is allowed to be turned on, if other safety and configuration states permit, the ZVCHG FET is turned off if *DF:Operation Cfg A [ZVCHG1, ZVCHG0]* are set appropriately, *SBS.BatteryStatus( ) [TCA]* is reset, *SBS.ChargingCurrent( )* and *SBS.ChargingVoltage( )* are set to the appropriate value per the charging algorithm, and the appropriate *SBS.SafetyStatus( )* flag is reset.

When a discharging-fault recovery condition is detected, the discharge FET is allowed to be turned on if other safety and configuration states permit the ZVCHG FET is turned off if *DF:Operation Cfg A [ZVCHG1, ZVCHG0]* are set appropriately, *SBS.BatteryStatus( ) [TDA]* is reset, *SBS.ChargingCurrent( )* and *SBS.ChargingVoltage( )* are set to the appropriate value per the charging algorithm and the *SBS.OperationStatus( ) [XDSG]* and the appropriate *SBS.SafetyStatus( )* flags are reset.

NAME	CLASS / SUBCLASS	FORMAT	VALID RANGE	SIZE (BYTES)	UNITS	DEFAULT VALUE	
OC (1st Tier) Chg	1st Level Protection / Current (1)	Integer	0 to 20000	2	mA	6000	
OC Chg Recovery			0 to 1000	2		200	
OC (1st Tier) Chg Time			0 to 60	1	s	2	
Current Recovery Time			0 to 60	1	s	8	
OC (1st Tier) Dsg			0 to 20000	2	mA	6000	
OC Dsg Recovery			0 to 1000	2	mA	200	
OC (1st Tier) Dsg Time			0 to 60	1	s	5	
OC (2nd Tier) Chg			0 to 20000	2	mA	8000	
OC (2nd Tier) Chg Time			0 to 60	1	s	2	
OC (2nd Tier) Dsg			0 to 20000	2	mA	6000	
OC (2nd Tier) Dsg Time			0 to 60	1	s	2	
AFE OC Dsg			Hex	00 to 1f	1	N/A	0x12
AFE OC Dsg Recovery			Integer	10 to 1000	2	mA	100
AFE OC Dsg Time	Hex	00 to 0f	1	N/A	0x0f		

### Short-Circuit Protection

The bq20z80 short-circuit protection is controlled by the bq29312A, but is recovered by the bq20z80. This allows different recovery methods to accommodate various applications.

The bq29312A charge short-circuit and discharge short-circuit protection are configured by the bq20z80 in *DF:AFE SC Chg Cfg* (see bq29312A SCC register) and *DF:AFE SC Dsg Cfg* (see bq29312A SCD register), respectively. See the 'Short-circuit Detection' section of the bq29312A data sheet for more details and the appropriate values to use.

Short Circuit	DF NAME	FET	SBS.SAFETYSTATUS( ) AND DF:Nonremovable Cfg	DF CLEAR THRESHOLD
Charge	AFE SC Chg Cfg	CHG	ASCC	AFE SC Recovery
Discharge	AFE SC Dsg Cfg	DSG	ASCD	

When the bq29312A detects a short circuit in charge or short circuit in discharge fault, the charge and discharge FETs are turned off, the XALERT pin of the bq20z80 is driven low by the XALERT pin of the bq29312A and the bq29312A is interrogated. When the bq20z80 identifies the short-circuit condition (charge or discharge current direction), the internal *AFE\_Current\_Fault* timer is started from 0, either of *SBS.BatteryStatus( ) [TCA, TDA]* are set, *SBS.ChargingCurrent( )* and *SBS.ChargingVoltage( )* is set to 0, and *SBS.SafetyStatus( ) [ASCC, ASCD]* is set. If the short-circuit condition is in discharge, then *SBS.OperationStatus( ) [XDMSG]* is also set.

However, when the bq20z80 has *SBS.SafetyStatus( ) [ASCC]* set, the CHG FET is turned on again, as long as *SBS.Current( )* is reported to  $\leq$  *DF:Dsg Current Threshold*. Also, when the bq20z80 has *SBS.SafetyStatus( ) [SCD]* set, the DSG FET is turned on again, as long as *SBS.Current( )* is reported to be  $\geq$  *DF:Chg Current Threshold*. No other flags change state until full recovery is reached. This prevents overheating of charge- or discharge-FET body diode during operation. This action is not affected by the state of *DF:Operation Cfg B [NR]*.

Each bq20z80 short-circuit protection feature can be individually configured to recover via two different methods, based on *DF:Operation Cfg B [NR]*.

**Standard Recovery** is where *DF:Operation Cfg B [NR] = 0* and the overcurrent tier is not selected in *DF:Non-Removable Cfg*. When the pack is removed and re-inserted, the condition is cleared. Pack removal and re-insertion is detected by transition on the PRES input from low to high to low. When the tier is not selected in *DF:Non-Removable Cfg*, that particular feature uses the Nonremovable Battery Mode recovery.

**Nonremovable Battery Mode Recovery** is where *DF:Operation Cfg B [NR] = 1*. The state of *DF:Non-Removable Cfg* has no consequence when *DF:Operation Cfg B [NR] = 1*. This recovery requires *SBS.AverageCurrent( )* to be  $\leq$  *DF:AFE SC Recovery* threshold and for the internal *AFE\_Current\_Fault* timer to be  $\geq$  *DF:Current Recovery Time*.

When the recovery condition for a charging fault is detected, the charge FET is allowed to be turned on if other safety and configuration states permit. The ZVCHG FET is turned off if *DF:Operation Cfg A [ZVCHG1, ZVCHG0]* are set appropriately. When this occurs, *SBS.BatteryStatus( ) [TCA]* is reset, *SBS.ChargingCurrent( )* and *SBS.ChargingVoltage( )* are set to the appropriate values per the charging algorithm, and the appropriate *SBS.SafetyStatus( )* flag is reset.

When the recovery condition for a discharging fault is detected, the discharge FET is allowed to be turned on if other safety and configuration states permit. The ZVCHG FET is turned off if *DF:Operation Cfg A [ZVCHG1, ZVCGH0]* are set appropriately. When this occurs *SBS.BatteryStatus( ) [TDA]* is reset, *SBS.ChargingCurrent( )* and *SBS.ChargingVoltage( )* are set to the appropriate value per the charging algorithm, and *SBS.OperationStatus( ) [XDMSG]* and the appropriate *SBS.SafetyStatus( )* flags are reset.

NAME	CLASS / SUBCLASS	FORMAT	VALID RANGE	SIZE (BYTES)	UNITS	DEFAULT VALUE
AFE SC Chg Cfg	1st Level Safety / Current (1)	Low Nibble = AFE SC Chg	Hex	0x00 to 0xff	N/A	0x77
		High Nibble = AFE SC Chg Time				
AFE SC Dsg Cfg		Low Nibble = AFE SC Dsg				0x77
		High Nibble = AFE SC Dsg Time				
AFE SC Recovery		Integer	0 to 200	2	mA	1



## Overtemperature Protection

The bq20z80 has overtemperature protection for both charge and discharge conditions. In either case, if  $SBS.Temperature()$  is  $\geq$  the protection threshold for a period  $\geq$  the protection delay time, then action is taken. However, if the delay time is set to 0, then the feature is disabled.

	DF THRESHOLD	DF TIME	FET	SBS.SAFETYALERT() SBS.SAFETYSTATUS()	DF CLEAR THRESHOLD
Charge	Over Temp Chg	OT Chg Time	CHG	OTC	OT Chg Recovery
Discharge	Over Temp Chg	OT Dsg Time	DSG	OTD	OT Dsg Recovery

During the period between detection of excessive temperature and the expiration of the timer, the respective  $SBS.SafetyAlert()$  bit is set. If the timer expires or  $SBS.Temperature()$  returns within the normal operation range, the  $SBS.SafetyAlert()$  bit is cleared.

If  $SBS.SafetyStatus()$  [OTC] becomes set and if  $DF:Operation Cfg B$  [OTFET] is set, the CHG FET is turned off and the ZVCHG FET turned off, if  $DF:Operation Cfg A$  [ZVCHG1, ZVCHG0] are set appropriately. If  $SBS.SafetyStatus()$  [OTD] becomes set and if  $DF:Operation Cfg B$  [OTFET] is set, the DSG FET turns off. If the  $DF:Operation Cfg B$  [OTFET] bit is cleared, no FET action is taken. Also,  $SBS.BatteryStatus()$  [OTA] is set,  $SBS.ChargingCurrent()$  and  $SBS.ChargingVoltage()$  are set to 0, either of  $SBS.BatteryStatus()$  [TCA, TDA] is set, and the corresponding flag in  $SBS.SafetyStatus()$  is set. If  $SBS.SafetyStatus()$  [OTD] is set AND  $DF:Operation Cfg B$  [OTFET] is set then  $SBS.OperationStatus()$  [XDMSG] is set.

However, when  $SBS.SafetyStatus()$  [OTC] is set, the CHG FET is turned on again, as long as  $SBS.Current()$  is reported to be  $\leq$  ( $-$ )  $DF:Dsg Current Threshold$ . Also, when the bq20z80 has  $SBS.SafetyStatus()$  [OTD] set, the DSG FET is turned on again, as long as  $SBS.Current()$  is reported to be  $\leq$   $DF:Chg Current Threshold$ . No other flags change state until full recovery is reached. This prevents overheating the respective FET's body diode during operation. This action is not affected by the state of  $DF:Operation Cfg B$  [NR].

For normal recovery to be achieved,  $SBS.Temperature()$  must be  $\leq$  the respective  $DF:OT Chg Recovery$  or  $DF:OT Dsg Recovery$ . When this occurs, the FETs are returned to the normal operating state if applicable,  $SBS.BatteryStatus()$  [OTA] is cleared, either of  $SBS.BatteryStatus()$  [TCA, TDA] is cleared,  $SBS.ChargingCurrent()$  and  $SBS.ChargingVoltage()$  are set to the appropriate values per the charging algorithm, and the appropriate  $SBS.SafetyStatus()$  flag is reset. If  $SBS.SafetyStatus()$  [OTD] is cleared, then  $SBS.OperationStatus()$  [XDMSG] is cleared.

NAME	CLASS / SUBCLASS	FORMAT	VALID RANGE	SIZE (BYTES)	UNITS	DEFAULT VALUE
Over Temp Chg	1st Level Safety / Temperature (2)	Integer	0 to 1200	2	0.1°C	550
OT Chg Recovery			0 to 1200	2	0.1°C	500
OT Chg Time			0 to 60	1	s	2
Over Temp Dsg			0 to 1200	2	0.1°C	600
OT Dsg Time			0 to 30	1	s	2
OT Dsg Recovery			0 to 1200	2	0.1°C	550

## AFE Watchdog

The bq29312A incorporates a watchdog feature that automatically turns off the CHG, DSG, and ZVCHG FETs if the bq29312A does not receive the appropriate frequency input on the WDI pin. The bq20z80 has no warning that this is about to happen, but it can report the occurrence, once the bq20z80 is able to interrogate the bq29312A.

When the XALERT input of the bq20z80 is triggered by the XALERT pin of the bq29312A, the bq20z80 reads  $AFE.STATUS$ . If  $AFE.STATUS$  [WDF] is set, then  $SBS.SafetyStatus()$  [WDF] is set, and periodic verification of the bq29312A RAM is undertaken. If verification of the bq29312A RAM fails then  $SBS.SafetyStatus()$  [WDF] is set and the FETs will turn off. Verification of the bq29312A RAM will continue every second. If the periodic verification passes, then  $SBS.SafetyStatus()$  [WDF] is cleared and the FETs returned to normal operation. If  $DF:AFE Check Time = 0$  then on detection of a verification fault the  $DF:PF Flags 1$  [AFE\_C] will NOT be set and PF mode will NOT be entered. If  $DF:AFE Check Time$  is not 0 then if  $DF:AFE Check Time$  attempts of the verification fail, the bq20z80 sets  $DF:PF Flags 1$  [AFE\_P] and enters permanent failure. See Periodic AFE Verification for further details.

SLUS625D–SEPTEMBER 2004–REVISED OCTOBER 2005

<b>NAME</b>	<b>CLASS / SUBCLASS</b>	<b>FORMAT</b>	<b>VALID RANGE</b>	<b>SIZE (BYTES)</b>	<b>UNITS</b>	<b>DEFAULT VALUE</b>
AFE Check Time	1st Level Safety / AFE Watchdog (3)	Integer	0 to 255	1	Faults	0

## Host Watchdog

The bq20z80 can be configured to require the host system to communicate with the battery periodically, else the battery disables charging and discharging. The Host Watchdog function is only active in Normal Power mode and is disabled if the timeout period is set to 0.

If the bq20z80 does not receive any valid SMBus communications for a period of time  $\geq DF:Host\ Watchdog\ Timeout$ , the FETs are turned off, *SBS.ChargingVoltage( )* and *SBS.ChargingCurrent( )* are cleared to 0, *SBS.BatteryStatus( ) [TCA, TCA]*, *SBS.OperationStatus( ) [XDSG]*, *SBS.SafetyStatus( ) [HWDG]* are set.

For normal recovery to be achieved, normal SMBus communications must be resumed. When this occurs, the FETs are returned to the normal operating state, *SBS.BatteryStatus( ) [TCA, TDA]* are cleared, *SBS.ChargingCurrent( )* and *SBS.ChargingVoltage( )* are set to the appropriate value per the charging algorithm and *SBS.OperationStatus( ) [XDSG]* and *SBS.SafetyStatus( ) [HWDG]* are reset.

NAME	CLASS / SUBCLASS	FORMAT	VALID RANGE	SIZE (BYTES)	UNITS	DEFAULT VALUE
Host Watchdog Timeout	1st Level Safety / Host Comm (3)	Integer	0 to 255	1	s	0

## 2nd LEVEL PROTECTION FEATURES

The bq20z80 provides features that can be used to indicate a more serious fault via the  $\overline{\text{SAFE}}$  and SAFE outputs. These outputs can be used to blow an in-line fuse to permanently disable the battery pack from charge or discharge activity.

### Actions on Detection of 2nd Level (Permanent) Failure

When the bq20z80 *SBS.PFStatus()* changes from 0x00 to indicate a permanent failure then the following actions are taken in sequence.

- CHG, DSG, and ZVCHG FETs are turned OFF.
- *SBS.BatteryStatus()* [TCA, TDA] are set.
- A backup of SBS data is stored to data flash including *SBS.Voltage()*, *SBS.CellVoltage1()*, *SBS.CellVoltage2()*, *SBS.CellVoltage3()*, *SBS.CellVoltage4()*, *SBS.Current()*, *SBS.Temperature()*, *SBS.BatteryStatus()*, *SBS.RemainingCapacity()*, *SBS.SafetyStatus()*, *SBS.ChargingStatus()*, *AFE.Data* (complete memory map).
- Data Flash write access is then disabled, but the data flash can be read.
- *SBS.ChargingCurrent()* and *SBS.ChargingVoltage()* are set to 0.
- The appropriate bit in *DF:PF Flag 1* is set.
- If the appropriate bit in *DF:Permanent Fail Cfg* is set, then 0x3672 is programmed to *DF:Fuse Flag*, the  $\overline{\text{SAFE}}$  pin is driven and latched low, and the SAFE pin is driven and latched high.
- *SBS.SafetyStatus()* [PF] is set.

NAME	CLASS / SUBCLASS	FORMAT	VALID RANGE	SIZE (BYTES)	UNITS	DEFAULT VALUE
PF Flags 1	2nd Level Safety / Device Status Data (96)	Hex	0x0000 to 0xffff	2	N/A	0x0000
Fuse Flag			0x0000 or 0x3672	2	N/A	0x0000
PF Voltage		Integer	0 to 65535	2	mV	0
PF C1 Voltage				2	mV	0
PF C2 Voltage				2	mV	0
PF C3 Voltage				2	mV	0
PF C4 Voltage				2	mV	0
PF Current				-32768 to 32767	2	mA
PF Temperature		-9999 to 9999	2	0.1°C	0	
PF Batt Stat		Hex	0x0000 to 0xffff	2	N/A	0x0000
PF RC-mAh		Integer	0 to 65535	2	mAh	0
PF RC-10mWh				2	10mWh	0
PF Chg Status		Hex	0x0000 to 0xffff	2	N/A	0x0000
PF Safety Status				2	N/A	0x0000
PF Flags 2				2	N/A	0x0000
AFE Status	2nd Level Safety / AFE Regs (97)	Hex	0x00 to 0xff	1	N/A	0x00
AFE Output			0x00 to 0xff	1	N/A	0x00
AFE State			0x00 to 0xff	1	N/A	0x00
AFE Function			0x00 to 0xff	1	N/A	0x00
AFE Cell Select			0x00 to 0xff	1	N/A	0x00
AFE OLV			0x00 to 0xff	1	N/A	0x00
AFE OLT			0x00 to 0xff	1	N/A	0x00
AFE SCC			0x00 to 0xff	1	N/A	0x00
AFE SCD			0x00 to 0xff	1	N/A	0x00

## Permanent Failure Flags

When any NEW cause of PF is detected in *SBS.PFStatus( )*, the NEW cause is added to *DF:PF Flag 1*. This allows *DF:PF Flag 1* to show ALL of the different permanent failure conditions that have occurred.

On the first occasion of *SBS.PFStatus( )* changing from 0x00 the value is stored to *DF:PF Flag 2*.

## Clearing Permanent Failure

The bq20z80 permanent failure mode can be cleared by sending two *SBS.ManufacturerAccess( )* commands in sequence. See *SBS.ManufacturerAccess( )* for more details.

## Safety Overvoltage Protection

The bq20z80 reports a safety-overvoltage condition when *SBS.Voltage( )* is  $\geq$  the *DF:SOV Threshold* for a period  $\geq$  *DF:SOV Time*. During the time between when the excessive voltage is first detected and the expiration of *DF:SOV Time* *SBS.PFAlert( ) [SOV]* is set.

If *DF:Permanent Fail Cfg [XSOV]* is set, the  $\overline{\text{SAFE}}$  pin is driven low and the SAFE pin is driven high. If *DF:SOV Time* is set to 0, this feature is disabled.

NAME	CLASS / SUBCLASS	FORMAT	VALID RANGE	SIZE (BYTES)	UNITS	DEFAULT VALUE
SOV Threshold	2nd Level Safety / Voltage (16)	Integer	0 to 20000	2	mV	18000
SOV Time			0 to 30	1	s	0 (4 typical)

## Cell Imbalance Fault Protection

The bq20z80 reports a cell imbalance condition when *SBS.Current( )* is  $\leq$  *DF:Cell Imbalance Current* for a period of *DF:Battery Rest Time*, AND the difference between the highest measured cell voltage (*SBS.CellVoltage( )MAX*) and lowest measured cell voltage (*SBS.CellVoltage( )MIN*) is  $\geq$  *DF:Cell Imbalance Fail Voltage* for a period  $\geq$  *DF:Cell Imbalance Time*.

During the time between when excessive cell-voltage variance is first detected and the expiration of *DF:Cell Imbalance Time*, *SBS.PFAlert( ) [CIM]* is set.

If *DF:Permanent Fail Cfg [XCIM]* is set, the  $\overline{\text{SAFE}}$  pin is driven low and the SAFE pin is driven high. If *DF:Cell Imbalance Time* is set to 0, this feature is disabled.

NAME	CLASS / SUBCLASS	FORMAT	VALID RANGE	SIZE (BYTES)	UNITS	DEFAULT VALUE
Cell Imbalance Fail Voltage	2nd Level Safety/ Voltage (16)	Integer	0 to 5000	2	mV	1000
Cell Imbalance Time			0 to 30	1	s	0 (4 typical)
Cell Imbalance Current			0 to 200	1	mA	5
Battery Rest Time			0 to 240	1	s	60

## 2nd Level Protection IC Input

The  $\overline{\text{PFIN}}$  input of the bq20z80 can be used to determine the state of an external protection device such as the bq29400. If this pin is logic low for a period of time  $\geq$  *DF:PFIN Detect Time*, the Permanent Failure Mode is entered. During the time between when  $\overline{\text{PFIN}}$  is detected low and the expiration of *DF:PFIN Detect Time* *SBS.PFAlert( ) [PFIN]* is set.

If *DF:Permanent Fail Cfg [XPFIN]* is set, the  $\overline{\text{SAFE}}$  pin is driven low and the SAFE pin is driven high. Also, if *DF:PFIN Detect Time* is set to 0, this feature is disabled.

NAME	CLASS / SUBCLASS	FORMAT	VALID RANGE	SIZE (BYTES)	UNITS	DEFAULT VALUE
PFIN Detect Time	2nd Level Safety / Voltage (16)	Integer	0 to 30	1	s	0 (4 typical)

### Safety Overcurrent Protection

The bq20z80 reports a safety-overcurrent condition for either charge ( $SBS.Current() = \text{positive}$ ) or discharge ( $SBS.Current() = \text{negative}$ ). A fault is reported when  $SBS.Current()$  is  $\geq$  the  $DF:SOC\ Chg$  or  $DF:SOC\ Dsg$  threshold for a period  $\geq DF:SOC\ Chg\ Time$  or  $\geq$  the  $DF:SOC\ Dsg\ Time$ . During the period between the time when excessive current, in charge, is first detected and the expiration of  $DF:SOC\ Chg\ Time$ ,  $SBS.PFAlert() [SOCC]$  is set. Between the time when excessive current, in discharge, is first detected and the expiration of  $DF:SOC\ Dsg\ Time$ ,  $SBS.PFAlert() [SOCC]$  is set.

The protection in discharge or charge can be independently configured or disabled. If either  $DF:Permanent\ Fail\ Cfg [XSOCC, XSOCD]$  are set, the  $\overline{SAFE}$  pin is driven low and the  $SAFE$  pin is driven high. Also, if  $DF:SOC\ Chg\ Time$  or  $DF:SOC\ Dsg\ Time$  are set to 0, this feature is disabled for the respective current direction.

NAME	CLASS / SUBCLASS	FORMAT	VALID RANGE	SIZE (BYTES)	UNITS	DEFAULT VALUE
SOC Chg	2nd Level Safety / Current (17)	Integer	0 to 30000	2	mA	10000
SOC Dsg			0 to 30000			10000
SOC Chg Time			0 to 30	1	s	0 (4 typical)
SOC Dsg Time			0 to 30	1	s	0 (4 typical)

### Safety Overtemperature Protection

The bq20z80 reports a safety overtemperature condition for either charge ( $SBS.Current() = \text{positive}$ ) or discharge ( $SBS.Current() = \text{negative}$ ). A fault is reported when  $SBS.Temperature() \geq DF:SOT\ Chg$  or  $DF:SOT\ Dsg$  threshold for a period  $\geq DF:SOT\ Chg\ Time$  or  $DF:SOT\ Dsg\ Time$ . During the period between the time when excessive temperature, in charge, is first detected and the expiration of  $DF:SOT\ Chg\ Time$ ,  $SBS.PFAlert() [SOTC]$  is set. Between the time when excessive temperature, in discharge, is first detected and the expiration of  $DF:SOT\ Dsg\ Time$ ,  $SBS.PFAlert() [SOTD]$  is set.

Either discharge or charge protection can be independently configured or disabled. If either  $DF:Permanent\ Fail\ Cfg [XSOTC, XSOTD]$  is set, the  $\overline{SAFE}$  pin is driven low and the  $SAFE$  pin is driven high. If  $DF:SOT\ Chg\ Time$  or  $DF:SOT\ Dsg\ Time$  is set to 0, this feature is disabled for the respective current direction.

NAME	DESCRIPTION	FORMAT	VALID RANGE	SIZE (BYTES)	UNITS	DEFAULT VALUE
SOT Chg	2nd Level Safety / Temperature (18)	Integer	0 to 1200	2	0.1°C	650
SOT Chg Time			0 to 30	1	s	0 (4 typical)
SOT Dsg			0 to 1200	2	0.1°C	750
SOT Dsg Time			0 to 30	1	s	0 (4 typical)

The bq20z80 reports an open thermistor condition when  $SBS.Temperature() \leq DF:Open\ Thermistor$  for a time  $\geq DF:Open\ Time$ .

Between the time when excessive temperature is first detected and the expiration of  $DF:Open\ Time$ ,  $SBS.PFAlert() [OTS]$  is set. When  $DF:Open\ Time$  expires or is cleared then  $SBS.PFAlert() [OTS]$  is cleared

If  $DF:Permanent\ Fail\ Cfg [XOTS]$  is set, the  $\overline{SAFE}$  pin is driven low and the  $SAFE$  pin is driven high. If  $DF:Open\ Time$  is set to 0, this feature is disabled.

NAME	CLASS / SUBCLASS	FORMAT	VALID RANGE	SIZE (BYTES)	UNITS	DEFAULT VALUE
Open Thermistor	2nd Level Safety / Temperature (18)	Signed Int	-1000 to 1200	2	0.1°C	-333
Open Time			0 to 30	1	s	0 (4 typical)

### Charge and Zero-Volt Charge FET Fault Protection

If the bq20z80 has at any time attempted to turn off the CHG or ZVCHG FETs, or *AFE.OUTPUT [CHG]* is set, and a level of charge *SBS.Current( )* continues to flow that is  $\geq DF:FET\ Fail\ Limit$  for a period of *DF:FET Fail Time*, then a CHG FET fault is reported.

When the first occurrence of excessive level of charge *SBS.Current( )* is detected, *SBS.PFAlert( ) [CFETF]* is set, and the bq20z80 attempts to turn off the CHG and ZVCHG FET again. *SBS.PFAlert( ) [CFETF]* is cleared if at any time before the expiration of *DF:FET Fail Time*, the current is measured below the *DF:FET Fail Limit* threshold.

If *DF:Permanent Fail Cfg [XCFETF]* is set, the  $\overline{SAFE}$  pin is driven low and the SAFE pin is driven high. If *DF:FET Fail Time* is set to 0, this feature is disabled.

NAME	CLASS / SUBCLASS	FORMAT	VALID RANGE	SIZE (BYTES)	UNITS	DEFAULT VALUE
FET Fail Limit	2nd Level Safety / FET Verification (18)	Integer	0 to 500	2	mA	20
FET Fail Time			0 to 30	1	s	0 (2 typical)

### Discharge FET Fault Protection

If the bq20z80 has at any time attempted to turn off the DSG FET, or *AFE.OUTPUT [DSG]* is set, and a level of discharge *SBS.Current( )* continues to flow  $\geq (-) DF:FET\ Fail\ Limit$  for a period of *DF:FET Fail Time*, then a DSG FET fault is reported. If *DF:FET Fail Time* is set to 0, the feature is completely disabled.

When the first occurrence of excessive level of discharge *SBS.Current( )* is detected, *SBS.PFAlert( ) [DFETF]* is set, and the bq20z80 attempts to turn off the DSG FET again. *SBS.PFAlert( ) [DFETF]* is cleared if at any time before the *DF:FET Fail Time* times out, the current is measured below the  $(-) DF:FET\ Fail\ Limit$  threshold.

If *DF:Permanent Fail Cfg [XDFETF]* is set, the  $\overline{SAFE}$  pin is driven low and the SAFE pin is driven high. If *DF:FET Fail Time* is set to 0, this feature is disabled.

### AFE Communication Fault Protection (AFE\_C)

The bq20z80 continuously validates its read and write communications with the bq29312A. If either a read or write verify fails, an internal *AFE\_Fail\_Counter* is incremented. If the *AFE\_Fail\_Counter*  $> DF:AFE\ Fail\ Limit$ , the bq20z80 reports a permanent failure. If the *DF:AFE Fail Limit* is set to 0, this feature is *not* disabled, but reports a permanent failure after only one AFE communication fault. An AFE\_C fault could also be declared if after a full reset the initial offset values read from the AFE cannot be verified. These values are A-to-D readings of the bq29312A VCELL output. The bq29312A offset values are verified by reading the values twice and confirming that the readings are within acceptable limits. If the offset value verification fails an AFE\_C fault is declared.

The internal *AFE\_Fail\_Counter* is decremented by one count each *DF:AFE Fail Recovery Time*.

If *DF:Permanent Fail Cfg [XAFE\_C]* is set, the  $\overline{SAFE}$  pin is driven low and the SAFE pin is driven high.

NAME	CLASS / SUBCLASS	FORMAT	VALID RANGE	SIZE (BYTES)	UNITS	DEFAULT VALUE
AFE Fail Limit	2nd Level Safety / AFE Verification (20)	Integer	0 to 255	1	counts	10
AFE Fail Recovery Time			0 to 255	1	s	20

### Periodic AFE Verification

The bq20z80 periodically (*DF:AFE Check Time*) compares the entire RAM in the bq29312A with that of the bq20z80 data flash and the expected control-bit states. If an error is detected, the internal *AFE\_Fail\_Counter* is incremented. If the internal *AFE\_Fail\_Counter* reaches the *DF:AFE Fail Limit*, the bq20z80 reports a permanent failure and *SBS.PFStatus( ) [AFE\_P]* is set.

The internal *AFE\_Fail\_Counter* is decremented by one count each *DF:AFE Fail Recovery Time*.

However, if *DF:Permanent Fail Cfg [XAFE\_P]* is set, the  $\overline{\text{SAFE}}$  pin is driven low and the SAFE pin is driven high, and if *DF:AFE Check Time* is set to 0, this feature is disabled.

NAME	CLASS / SUBCLASS	FORMAT	VALID RANGE	SIZE (BYTES)	UNITS	DEFAULT VALUE
AFE Check Time	2nd Level Safety / AFE Verification (20)	Integer	0 to 255	1	s	0 (10 typical)

### Data Flash Failure

The bq20z80 can detect if the data flash is not operating correctly. *DF:PF Flags 1 [DFF]* is set when either (i) After a full reset the instruction flash checksum does not verify, (ii) if any data flash write does not verify or (iii) if any data flash erase does not verify.

If *DF:Permanent Fail Cfg [XDFF]* is set, the  $\overline{\text{SAFE}}$  pin is driven low and the SAFE pin is driven high when *DF:PF Flags 1 [DFF]* becomes set.

### Fuse State Detection

The bq20z80 can detect if an attempt has been made to blow the fuse, but this has failed. If the bq20z80 *DF:PF Flag 1* is set and *SBS.Current( )* is  $\geq$  *DF:Fuse Fail Limit* in either charge or discharge directions for a period  $\geq$  the *DF:Fuse Fail Time*, *SBS.PFStatus( ) [FBF]* is set.

When the *DF:Fuse Fail Time* timer begins, *SBS.PFAlert( ) [FBF]* is set. When the *DF:Fuse Fail Time* timer expires or is cleared, *SBS.PFAlert( ) [FBF]* is cleared.

LABEL	CLASS / SUBCLASS	FORMAT	VALID RANGE	SIZE (BYTES)	UNITS	DEFAULT VALUE
Fuse Fail Time	2nd Level Safety / Fuse Verification (21)	Integer	0 to 30	1	s	0 (10 typical)
Fuse Fail Limit			0 to 20	1	mA	2



## COMMUNICATIONS

The bq20z80 uses SMBus v1.1 with Master Mode and package error checking (PEC) options per the SBS specification.

### SMBus On and Off State

The bq20z80 detects an SMBus off state when SMBC and SMBD are logic-low for  $\geq 2$  seconds. Clearing this state requires either SMBC or SMBD to transition high. Within 1 ms, the communication bus is available.

### Packet Error Checking

The bq20z80 can receive or transmit data with or without PEC.

In the read-word protocol, the bq20z80 receives the PEC after the last byte of data from the host. If the host does not support PEC, the last byte of data is followed by a stop condition. After receipt of the PEC, the bq20z80 compares the value to its calculation. If the PEC is correct, the bq20z80 responds with an ACKNOWLEDGE. If it is not correct, the bq20z80 responds with a NOT ACKNOWLEDGE and sets an error code.

In the write-word and block-read in master mode, the host generates an ACKNOWLEDGE after the last byte of data sent by the bq20z80. The bq20z80 then sends the PEC, and the host, acting as a master-receiver, generates a NOT ACKNOWLEDGE and a stop condition.

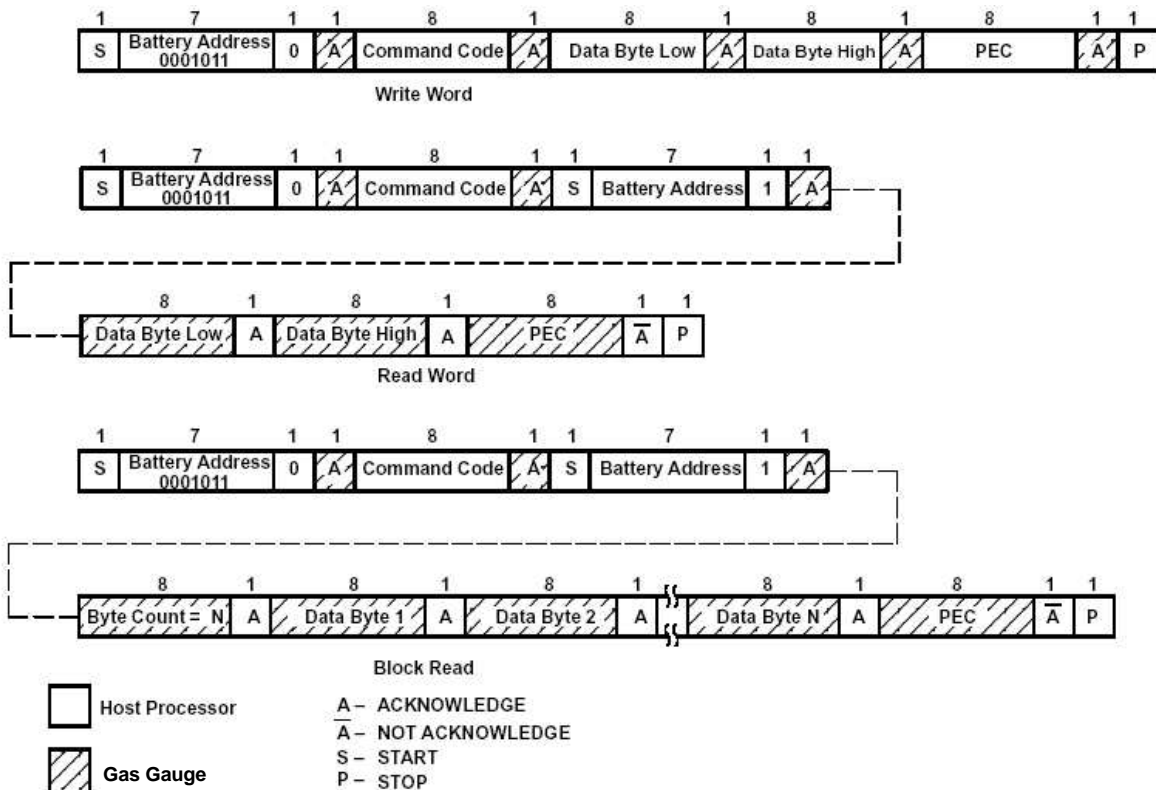

Figure 1. SMBus Communication Protocol Without PEC

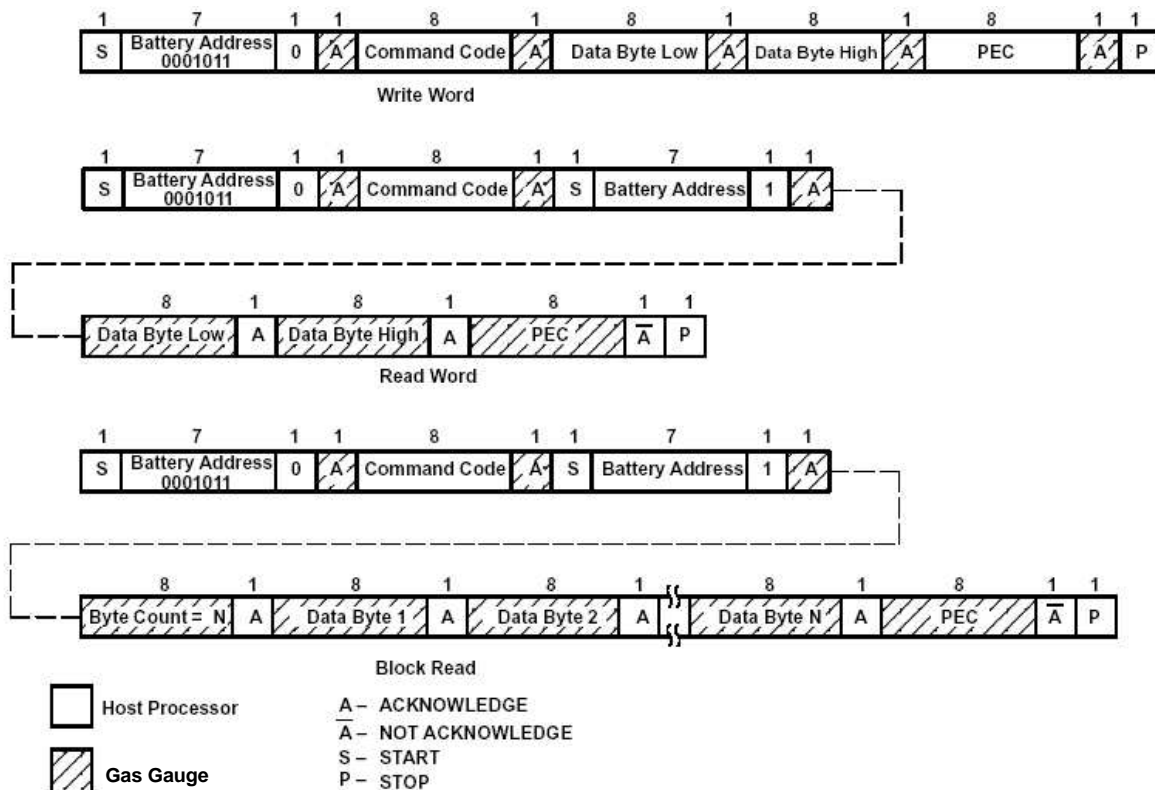

Figure 2. SMBus Communication Protocol With PEC

**PEC Calculation**

PEC calculation is an 8-bit cyclic redundancy check (CRC-8) based on the polynomial  $C(X) = X^8 + X^2 + X^1 + 1$ . All bytes in the transmission are used in the calculation, including: Address, Command, and Data. Not included: ACKNOWLEDGE, NOT ACKNOWLEDGE, start, stop, and repeated start.

**STANDARD SBS COMMANDS**

The bq20z80 SBS commands meet the SBD v1.1 specification.

**ManufacturerAccess( ) (0x00)**

This read- or write-word function provides battery-system level data, access to test controls, and security features.

**System Data (Returns Data)**

The commands in this section provide data to be read from 0x00 after the command has been written.

**Device Type:** 0x0001, Returns IC part number. 0x0800 - The number is not stored in data flash, but is part of the instruction flash.

**Firmware Version:** 0x0002, Returns the firmware version. This is not stored in data flash, but is part of the instruction flash. Its format is most-significant byte (MSB) = Decimal integer, and the least-significant byte (LSB) = sub-decimal integer, e.g., 0x0120 = version 01.20.

**Hardware Version:** 0x0003, Returns the hardware version stored in single byte of reserved data flash. E.G.: 0xa2 = Version A2.

**DF Checksum:** 0x0004, This function is only available when the bq20z80 is *Unsealed* (*SBS.OperationStatus()* [SS] = 0). A write to this command forces the bq20z80 to generate a checksum of the full Data Flash (DF) array and writes it to DF: The generated checksum is then returned within 45 ms.

**NOTE:**

If another SMBus command is received while the checksum is being generated, the DF Checksum is generated but the response may be time out (<25ms).

**Manufacturer Status:** 0x0006, This function is compatible with the equivalent command in the bq2084, and is available while the bq20z80 is in normal operation.

This 16-bit word reports the battery status and is formatted the same as the bq2084.

ManufacturerStatus	bit7	bit6	bit5	bit4	bit3	bit2	bit1	bit0
High Byte	FET1	FET0	PF1	PF0	STATE3	STATE2	STATE1	STATE0
Low Byte	0	0	0	0	0	0	1	0

**FET1, FET0** Indicated the state of the charge and discharge FETs

- 0,0 Both charge and discharge FETs are on.
- 0,1 Charge FET is off, discharge FET is on.
- 1,0 Both charge and discharge FETs are off.
- 1,1 Charge FET is on, discharge FET is off.

**PF1, PF0** Indicates permanent failure cause when permanent failure indicated by STATE3-STATE0

- 0,0 Fuse is blown if enabled via *DF:PF Config* settings (default, ie: NOT CIM, SOV or xFETF).
- 0,1 Cell imbalance failure
- 1,0 Safety voltage failure
- 1,1 FET failure

**STATE3, STATE2, STATE1, STATE0** Indicates battery state as defined in Table 2

**Table 2. STATE Code for Manufacture Status**

STATE	STATE CODE (hex)	CORRESPONDING FLAG
Wake Up	0	SBS.OperationStatus( ) WAKE
Pre-Charge	3	SBS.ChargingStatus( ) PCHG and NOT SBS.BatteryStatus( ) DSG
Terminate Charge	7	SBS.ChargeStatus( ) MCHG and NOT SBS.BatteryStatus( ) DSG
Normal Charge	5	SBS.ChargingStatus( ) FCHG and NOT SBS.BatteryStatus( ) DSG
Normal Discharge	1	SBS.ChargingStatus( ) XCHG and NOT SBS.OperationStatus( ) XDSDG and NOT SBS.OperationStatus( ) XDSDGI
Depleted	e	[SBS.OperationStatus( ) XDSDG or XDSDGI] and SBS.BatteryStatus( ) DSG
Depleted AC		
Overheat Discharge		
Overheat Charge		
Battery Fail - Over Charge		
Battery Fail - Low Temperature	8	[SBS.ChargingStatus( ) OCHGI or OCHGV or PCMTO or FCMT0 or OC or XCHGLV] and NOT SBS.BatteryStatus( ) DSG
Battery Fail - Charger Termination		
Battery Fail	c	SBS.SafetyStatus( ) SCC, AOCD or SCD and NOT Over- Heat - Charge and NOT Over Heat - Discharge and NOT Battery Fail - Charge and NOT Battery Fail -Discharge

**Table 2. STATE Code for Manufacture Status (continued)**

STATE	STATE CODE (hex)	CORRESPONDING FLAG
Battery Fail - Charge	a	SBS.SafetyStatus( ) OCC or OCC2
Battery Fail - Discharge		SBS.SafetyStatus( ) OCD or OCD2
Over Heat - Charge	b	SBS.SafetyStatus( ) OTC
Over Heat - Discharge		SBS.SafetyStatus( ) OTD
Removed	f	NOT SBS.OperationStatus( ) PRES
Sleep	d	Communication causes exit of sleep
Permanent Failure	9	SBS.SafetyStatus( ) PF

**System Control (Triggers Actions)**

The commands in this section cause the bq20z80 to take actions when written. No data is returned.

**Shutdown Command: 0x0010** Instructs the bq20z80 to verify and enter Shutdown. This command is only available when the bq20z80 is in unsealed security mode (SBS.OperationStatus( ) [SS] = 0). See *Shutdown* in Power Modes.

**Sleep Command: 0x0011** Instructs the bq20z80 to enter Sleep. This command is only available when the bq20z80 is in unsealed security mode (SBS.OperationStatus( ) [SS] = 0). See *Sleep* in Power Modes.

**IT Enable: 0x0021** A write forces the bq20z80 to begin the Impedance Track™ algorithm and sets *DF:Update Status [ITEN]*. This also sets *SBS.OperationStatus( ) [VOK, QEN]*. VOK indicates that voltages are OK for a QMAX update for the Impedance Track™ algorithm. QEN indicates QMAX update is in progress. This function is only available when the bq20z80 is *Unsealed*.

<i>DF:Update Status</i>	bit7	bit6	bit5	bit4	bit3	bit2	bit1	bit0
Low Byte	RSVD	RSVD	RSVD	RSVD	RSVD	ITEN	RSVD	RSVD

**RSVD (bit 0, 1, 3, 4, 5, 6, 7)** Reserved and should be 0

**ITEN (bit 2)** 1 = Impedance Track™ algorithm and Lifetime data updating enabled

NAME	CLASS / SUBCLASS	FORMAT	VALID RANGE	SIZE (BYTES)	UNITS	DEFAULT VALUE
Update Status	Gas Gauging / State (82)	Hex	0x00 or 0x04	1	N/A	0x00

**Permanent Fail Clear: (1) 0x2673 then (2) 0x1712**, Instructs the bq20z80 to clear the Permanent Failure Status, clear the Permanent Failure Flag, clear the  $\overline{\text{SAFE}}$  and SAFE pins, and unlock the data flash for writes. This function is only available when the bq20z80 is *Unsealed*

**NOTE:**

(1) must be followed by (2). If the clear fails then (1) can only be re-sent after 4 seconds since the last communication in the failed attempt. If communication other than the second code occurs after the first code is sent, the clear fails.

**SAFE Activation: 0x0030** Drives the  $\overline{\text{SAFE}}$  pin low and the SAFE pin high. This function is only available when the bq20z80 is *Unsealed*.

**SAFE Clear: 0x0031** Drives the  $\overline{\text{SAFE}}$  pin high and the SAFE pin low, only if protection functions allow. This does not clear PF Mode. This function is only available when the bq20z80 is *Unsealed*.

**LEDs ON: 0x0032** Activates all configured LEDs to stay on. This function is only available when the bq20z80 is *Unsealed*.

**LEDs OFF: 0x0033** Deactivates all configured LEDs. This function is only available when the bq20z80 is *Unsealed*.

**Display ON: 0x0034** Activates the configured LED display per the level of *SBS.RemainingStateOfCharge( )*. The display turns off per the normal display configuration. This function is only available when the bq20z80 is *Unsealed*.

**Calibration Mode: 0x0040** Places the bq20z80 into calibration mode. See *Calibrating the bq20z80* application note for further details. This function is only available when the bq20z80 is *Unsealed*.

**bq20z80 Reset: 0x00041** When written to the bq20z80 undergoes a full reset. The bq20z80 clocks stretch during the few milli-seconds taken to complete the reset. This function is only available when the bq20z80 is *Unsealed*.

### **Security (Enables and Disables Features)**

There are three levels of secured operation within the bq20z80. To switch between the levels, different operations are needed with different codes. The three levels are Sealed, Unsealed, and Full Access.

**1. Full Access or Unsealed to Sealed: 0x0020** Instructs the bq20z80 to limit access to the SBS functions and data flash space and sets *SBS.OperationStatus( ) [SS]*. In sealed mode, standard SBS functions have access per the Smart Battery Data Specification - Appendix A. Extended SBS Functions and data flash are not accessible. Once in sealed mode, the part can never permanently return to Unsealed or Full Access modes.

**2. Sealed to Unsealed** Instructs the bq20z80 to extend access to the SBS and data flash space and clears *SBS.OperationStatus( ) [SS]*. In unsealed mode, all data, SBS, and DF have read/write access. Unsealing is performed by using the *SBS.ManufacturerAccess( )* command, and writing subsequently two unseal keys.

The unseal keys can be read and changed via the extended SBS block command *SBS.UnSealKey( )*.

To return to the Sealed mode, either a hardware reset is needed, or a command to transition from Full Access or Unsealed to Sealed.

**3. Unsealed to Full Access** Instructs the bq20z80 to allow Full Access to all SBS commands and data flash. The bq20z80 is shipped from TI in this mode. The keys for Unsealed to Full Access can be read and changed via the extended SBS block command *SBS.FullAccessKey( ) (0x61)* when in Full Access mode. Change from Unsealed to Full Access is performed by using the *SBS.ManufacturerAccess( )* command, and writing subsequently two Full Access keys. In Full Access mode, the command to go to Boot ROM can be sent.

Also available via the *SBS.ManufacturerAccess( )* commands are some of the extended SBS commands. The following commands available shown with the corresponding *SBS.ManufacturerAccess( )* code.

- *SBS.SafetyAlert( ) (0x0050)*
- *SBS.SafetyStatus( ) (0x0051)*
- *SBS.PFAlert( ) (0x0052)*
- *SBS.PFStatus( ) (0x0053)*
- *SBS.OperationStatus( ) (0x0054)*
- *SBS.ChargingStatus( ) (0x0055)*
- *SBS.ResetData( ) (0x0057)*
- *SBS.WDResetData( ) (0x0058)*
- *SBS.PackVoltage( ) (0x005a)*
- *SBS.AverageVoltage( ) (0x005d)*

### **RemainingCapacityAlarm( ) (0x01)**

This read or write function sets or gets a low-capacity alarm threshold unsigned integer value with a range of 0 to 65535 and units of either mAh or 10 mWh depending on the setting of *SBS.BatteryMode( ) [CAPACITY\_MODE]*. See the *SBS.BatteryMode( )* function for further information

When the *SBS.RemainingCapacity( )* is < *SBS.RemainingCapacityAlarm( )*, the bq20z80 sends *SBS.AlarmWarning( )* messages to the SMBus Host address with the *Remaining\_Capacity\_Alarm (RCA)* bit set. RCA is cleared when *SBS.RemainingCapacity( )* is ≥ *SBS.RemainingCapacityAlarm( )* AND *SBS.BatteryStatus( ) [DISCHARGING]* is set.

The default value of *SBS.RemainingCapacityAlarm( )* is set in *DF:Rem Cap Alarm*. If *SBS.RemainingCapacityAlarm( )* = 0, this alarm is disabled.

If *SBS.BatteryMode()* [ALARM\_MODE] is set, the *SBS.AlarmWarning()* message is disabled for a set time. See the *SBS.BatteryMode()* function for further information.

NAME	CLASS / SUBCLASS	FORMAT	VALID RANGE	SIZE (BYTES)	UNITS	DEFAULT VALUE
Rem Cap Alarm	SBS Configuration / Data (48)	Integer	0 to 700	2	mAh	300

### RemainingTimeAlarm() (0x02)

This read or write-word function sets or gets the Remaining Time Alarm unsigned integer value in minutes and with a range of 0 to 65,535.

When the *SBS.AverageTimeToEmpty()* is < *SBS.RemainingTimeAlarm()*, the bq20z80 sends *SBS.AlarmWarning()* messages to the SMBus Host with the *Remaining\_Time\_Alarm* (RTA) bit set.

The default value of *SBS.RemainingTimeAlarm()* is set in *DF:Rem Time Alarm*. If *SBS.RemainingTimeAlarm()* = 0, this alarm is disabled.

RTA is cleared when *SBS.RemainingTimeAlarm()* is ≤ *SBS.AverageTimeToEmpty()*, or when the *SBS.AverageTimeToEmpty()* is increased by charging.

If *SBS.BatteryMode()* [ALARM\_MODE] is set then the *SBS.AlarmWarning()* message is disabled for a set time. See the *SBS.BatteryMode()* function for further information.

NAME	CLASS / SUBCLASS	FORMAT	VALID RANGE	SIZE (BYTES)	UNITS	DEFAULT VALUE
Rem Time Alarm	SBS Configuration / Data (48)	Integer	0 to 100	2	s	10

### BatteryMode() (0x03)

This read- or write-word function selects the various battery operational modes and reports the battery's capabilities, modes, and flags minor conditions requiring attention.

BatteryMode()	bit7	bit6	bit5	bit4	bit3	bit2	bit1	bit0
High Byte	CapM	ChgM	AM	RSVD	RSVD	RSVD	PB	CC
Low Byte	CF	RSVD	RSVD	RSVD	RSVD	RSVD	PBS	ICC

The *SBS.BatteryMode()* word is divided into two halves, the High Byte which is read/write and the Low Byte which is read only. The default state of *SBS.BatteryMode()* is stored in *DF:Init Battery Mode*.

FIELD	FORMAT	ALLOWABLE VALUES
ICC = INTERNAL_CHARGE_CONTROLLER	Read Only	Fixed to 1
PBS = PRIMARY_BATTERY_SUPPORT	Read Only	Fixed to 0
CF = CONDITION_FLAG	Read Only	0 – Battery OK
		1 – Conditioning Cycle Requested
CC = CHARGE_CONTROLLER_ENABLED	Read/Write	Not used, Fixed to 0
PB = PRIMARY_BATTERY	Read/Write	Not use, Fixed to 0
AM = ALARM_MODE	Read/Write	0 – Enable AlarmWarning() broadcasts to Host and Smart Battery Charger (default)
		1 – Disable AlarmWarning() broadcast to Host and Smart Battery Charger
ChgM = CHARGER_MODE	Read/Write	0 – Enable ChargingVoltage() and ChargingCurrent() broadcasts to Smart Battery Charger (default)
		1 – Disable broadcasts of ChargingVoltage() and ChargingCurrent() to Smart Battery Charger
CapM = CAPACITY_MODE	Read/Write	0 – Report in mA or mAh (default)
		1 – Report in 10 mW or 10 mWh

**NOTE:**

*CF*, *AM*, *ChgM*, and *CapM* are the only bits described as they are the only ones used in the bq20z80. See the SBD specification for details on the remaining bits.

**CONDITION\_FLAG:** Is initially set and is then permanently cleared when QMAX or the RA table have been updated.

**ALARM\_MODE:** Disables the bq20z80's ability to master the SMBus and send *SBS.AlarmWarning()* messages to the SMBus Host and the Smart Battery Charger.

When *ALARM\_MODE* = 1, the bq20z80 does not master the SMBus, and *SBS.AlarmWarning()* messages are not sent to the SMBus Host and the Smart Battery Charger for a period of no more than 65 seconds and no less than 45 seconds. *ALARM\_MODE* is automatically cleared by the bq20z80 60 seconds after being set to 1.

When *ALARM\_MODE* = 0 (default), the bq20z80 sends the *SBS.AlarmWarning()* messages to the SMBus Host and the Smart Battery Charger any time an alarm condition is detected.

**NOTE:**

The system, as a minimum, is required to poll the Smart Battery every 10 seconds if the *ALARM\_MODE* bit is set.

**CHARGER\_MODE:** Enables or disables the bq20z80's transmission of *SBS.ChargingCurrent()* and *SBS.ChargingVoltage()* messages to the Smart Battery Charger.

When *CHARGER\_MODE* = 1, the bq20z80 does NOT transmit *SBS.ChargingCurrent()* and *SBS.ChargingVoltage()* values to the Smart Battery Charger.

When *CHARGER\_MODE* = 0 (default), the bq20z80 transmits the *SBS.ChargingCurrent()* and *SBS.ChargingVoltage()* values to the Smart Battery Charger when charging is desired.

**CAPACITY\_MODE:** Indicates if capacity information is reported in mA/mAh or 10 mW/10 mWh.

When *CAPACITY\_MODE* = 0 (default), the capacity information is reported in mA/mAh as appropriate. After changing the *CAPACITY\_MODE* bit, the following functions are instantaneously updated:

- *SBS.RemainingCapacityAlarm()*
- *SBS.AtRate()*
- *SBS.RemainingCapacity()*
- *SBS.FullChargeCapacity()*
- *SBS.DesignCapacity()*, *SBS.DesignCapacity()* changes between *DF:Design Capacity* or *DF:Design Energy* depending on the CM bit transition.

The following functions are calculated on the basis of capacity, and may be calculated differently depending on the *CAPACITY\_MODE* bit:

- *SBS.AtRateOK()* – Within 1s
- *SBS.AtRateTimeToEmpty()* – Within 1s
- *SBS.RunTimeToEmpty()* – Within 1s
- *SBS.AverageTimeToEmpty()* – Within 1s
- *SBS.RemainingTimeAlarm()* – Within 1s
- *SBS.BatteryStatus()* – Within 1s

NAME	CLASS / SUBCLASS	FORMAT	VALID RANGE	SIZE (BYTES)	UNITS	DEFAULT VALUE
Init Battery Mode	SBS Configuration / Data (48)	Hex	0x0000 to 0xffff	2	N/A	0x81

**AtRate() (0x04)**

This read- or write-word function is the first half of a two-function call set used to set the *AtRate* value used in calculations made by the *SBS.AtRateTimeToFull()*, *SBS.AtRateTimeToEmpty()*, and *SBS.AtRateOK()* functions. The *AtRate* units are in either current (mA) or power (10 mW) depending on the setting of the *SBS.BatteryMode()* *CAPACITY\_MODE* bit. See the *SBS.BatteryMode()* function for further information

When the *SBS.AtRate( )* value is positive, the *SBS.AtRateTimeToFull( )* function returns the predicted time to full-charge at the *AtRate* value of charge. When the *SBS.AtRate( )* value is negative, the *SBS.AtRateTimeToEmpty( )* function returns the predicted operating time at the *AtRate* value of discharge. When the *SBS.AtRate( )* value is negative, the *SBS.AtRateOK( )* function returns a Boolean value that predicts the battery's ability to supply the *AtRate* value of additional discharge energy (current or power) for 10 seconds.

The default value for *SBS.AtRate( )* is zero. It is a signed integer where the *SBS.AtRate( )* value is positive for charge, negative for discharge.

### AtRateTimeToFull( ) (0x05)

This read-word function returns an unsigned integer value of the predicted remaining time to fully charge the battery using a CC-CV method at the *SBS.AtRate( )* value in minutes, with a range of 0 to 65534. A value of 65,535 indicates that the *SBS.AtRate( )* = 0.

*SBS.AtRateTimeToFull( )* can report time based on constant current (*SBS.BatteryMode( )* [CAPACITY\_MODE] = 0) or constant power (*SBS.BatteryMode( )* [CAPACITY\_MODE] = 1), and updates within one second after the SMBus host sets the *SBS.AtRate( )* value. The bq20z80 automatically updates *SBS.AtRateTimeToFull( )* based on the *SBS.AtRate( )* at one-second intervals.

### AtRateTimeToEmpty( ) (0x06)

This read-word function returns an unsigned integer value of the predicted remaining operating time in minutes with a range of 0 to 65534, if the battery is discharged at the *SBS.AtRate( )* value. A value of 65,535 indicates that *SBS.AtRate( )* = 0.

*SBS.AtRateTimeToEmpty( )* can report time based on constant current (*SBS.OperationStatus( )* [Load\_Mode] = 0), or constant power (*SBS.OperationStatus( )* [Load\_Mode] = 1), and is updated within one second after the SMBus host sets the *SBS.AtRate( )* value. The bq20z80 automatically updates *SBS.AtRateTimeToEmpty( )* based on the *SBS.AtRate( )* at one-second intervals.

### AtRateOK( ) (0x07)

This read-word function returns a Boolean value that indicates whether or not the battery can deliver the *SBS.AtRate( )*-value of additional energy for 10 seconds.

If *SBS.AtRate( )* is  $\geq 0$ , the *SBS.AtRateOK( )* function *always* returns OK (logic 1).

The bq20z80 updates *SBS.AtRateOK( )* within one second after the SMBus host sets the *SBS.AtRate( )* value. The bq20z80 automatically updates *SBS.AtRateOK( )* based on *SBS.AtRate( )* at one-second intervals.

### Temperature( ) (0x08)

This read-word function returns an unsigned integer value of the temperature in units of 0.1°K, as measured by the bq20z80. It has a range of 0 to 6553.5°K.

The source of the measured temperature is configured by *DF:Operation Cfg A* [TEMP1, TEMP0].

TEMP1	TEMP0	TEMPERATURE() SOURCE <sup>(1)</sup>
0	0	Internal Temperature Sensor
0	1	TS1 Input (default)
1	0	Maximum of TS1 or TS2 Inputs
1	1	Average of TS1 and TS2 Inputs

(1) Both external temperature sensors, if used, MUST be the same type.



**Voltage( ) (0x09)**

This read-word function returns an unsigned integer value of the sum of the individual cell voltage measurements in mV with a range of 0 to 20000 mV.

**Current( ) (0x0a)**

This read-word function returns a signed integer value of the measured current being supplied (or accepted) by the battery in mA, with a range of –32,768 to 32,767. A positive value indicates charge current and negative indicates discharge.

**NOTE:**

*SBS.Current( )* is the average of four internal current measurements over a one-second period.

**AverageCurrent( ) (0x0b)**

This read-word function returns a signed integer value that approximates a one-minute rolling average of the current being supplied (or accepted) through the battery terminals in mA, with a range of -32,768 to 32,767.

*SBS.AverageCurrent( )* is calculated by a rolling IIR filtered average of *SBS.Current( )* data with a period of 14.5s. During the time after a reset and before 14.5s has elapsed the reported *SBS.AverageCurrent( )* = *SBS.Current( )*.

**MaxError( ) (0x0c)**

This read-word function returns an unsigned integer value of the expected margin of error, in %, in the state-of-charge calculation with a range of 1 to 100%.

*SBS.MaxError( )* is set to 100% on a full reset, and is updated by the following mechanism.

On QMAX and Ra table update, the *SBS.MaxError( )* is set to 1%.

On QMAX update, the *SBS.MaxError( )* is set to 3%

On Ra table update, the *SBS.MaxError( )* is set to 5%

*SBS.MaxError( )* is incremented 0.05% for every increment of *SBS.CycleCount( )* after the last QMAX update

**RelativeStateOfCharge( ) (0x0d)**

This read-word function returns an unsigned integer value of the predicted remaining battery capacity expressed as a percentage of *SBS.FullChargeCapacity( )*, in %, with a range of 0 to 100%.

**AbsoluteStateOfCharge( )(0x0e)**

This read-word function returns an unsigned integer value of the predicted remaining battery capacity expressed as a percentage of *SBS.DesignCapacity( )*, in %, with a range of 0 to 100% with any fractions of % rounded up. If *SBS.BatteryMode( )* [CAPACITY\_MODE] is set, then the predicted remaining capacity is a percentage of *SBS.RemainingCapacity( )* / *SBS.Design Energy( )*.

**NOTE:**

*SBS.AbsoluteStateOfCharge( )* can return values > 100%.

**RemainingCapacity( ) (0x0f)**

This read-word function returns an unsigned integer value, with a range of 0 to 65535, of the predicted charge or energy remaining in the battery. The *SBS.RemainingCapacity( )* value is expressed in either charge (mAh) or energy (10 mWh), depending on the setting of *SBS.BatteryMode( )* [CAPACITY\_MODE].

**FullChargeCapacity( ) (0x10)**

This read-word function returns an unsigned integer value, with a range of 0 to 65535, of the predicted pack capacity when it is fully charged. The *SBS.FullChargeCapacity( )* value is expressed in either charge (mAh) or power (10 mWh) depending on the setting of *SBS.BatteryMode( )* [CAPACITY\_MODE].

**RunTimeToEmpty( ) (0x11)**

This read-word function returns an unsigned integer value of the predicted remaining battery life at the present rate of discharge, in minutes, with a range of 0 to 65,534 min. A value of 65,535 indicates battery is not being discharged.

*SBS.RunTimeToEmpty( )* is calculated and updated based on current or power, depending on the setting of *SBS.BatteryMode( )* [CAPACITY\_MODE].

**AverageTimeToEmpty( ) (0x12)**

This read-word function returns an unsigned integer value of predicted remaining battery life, in minutes, based upon *SBS.AverageCurrent( )* with a range of 0 to 65534. A value of 65,535 indicates that the battery is not being discharged.

*AverageTimeToEmpty( )* is calculated based on current or power, depending on the setting of *BatteryMode( )* [CAPACITY\_MODE].

**AverageTimeToFull( ) (0x13)**

This read-word function returns an unsigned integer value of predicted remaining time until the battery reaches full charge, in minutes, based on *SBS.AverageCurrent( )* with a range of 0 to 65,535. A value of 65,534 indicates that the battery is not being charged.

**ChargingCurrent( ) (0x14)**

This read-word function returns an unsigned integer value of the desired charging rate, in mA, with a range of 0 to 65,535. A value of 65,535 indicates that a charger should operate as a voltage source outside its maximum regulated current range.

See Charging, 1st Level Safety and 2nd Level Safety sections of this data sheet for further details.

**ChargingVoltage( ) (0x15)**

This read-word function returns an unsigned integer value of the desired charging voltage, in mV, where the range is 0 to 65,534. A value of 65,535 indicates that the charger should operate as a current source outside its maximum regulated voltage range.

Review the Charging, 1st Level Safety and 2nd Level Safety sections of this data sheet for further information on this command.

**BatteryStatus( ) (0x16)**

This read-word function returns the status of the bq20z80-based battery.

*SBS.BatteryStatus( )* [RCA, RTA] are calculated on the basis of either current or power depending on the setting of *SBS.BatteryMode( )* [CAPACITY\_MODE].

BatteryStatus( )	bit7	bit6	bit5	bit4	bit3	bit2	bit1	bit0
High Byte	OCA	TCA	RSVD	OTA	TDA	RSVD	RCA	RTA
Low Byte	INIT	DSG	FC	FD	EC3	EC2	EC1	EC0

**Alarm Bits**

**OVER\_CHARGED\_ALARM (OCA):** See *Overcharge* in the *Charging* section of this data sheet.

**TERMINATE\_CHARGE\_ALARM (TCA):** See the *Gas Gauging*, *Charging*, *1st Level Safety*, and *2nd Level Safety* sections of this data sheet

**OVER\_TEMP\_ALARM (OTA):** See *Overttemperature* functions in the *1st Level Safety* and *2nd Level Safety*

sections of this data sheet.

**TERMINATE\_DISCHARGE\_ALARM (TDA):** See the *Gas Gauging, 1st Level Safety* and *2nd Level Safety* sections of this data sheet.

**REMAINING\_CAPACITY\_ALARM (RCA):** See *SBS.RemainingCapacityAlarm( )* section of the data sheet.

**REMAINING\_TIME\_ALARM (RTA):** See *SBS.RemainingTimeAlarm( )* section of the data sheet.

### Status Bits

**INITIALIZED:** Cleared after a full reset until all SBS parameters have been measured and updated (approx. 1s).

**DISCHARGING:** This bit is controlled under the following conditions.

STATE	CONDITION
Set (1)	$SBS.Current( ) \leq DF:Quit\ Current$ for a period of $DF:Charge\ Relax\ Time$
	$SBS.Current( ) \leq DF:Quit\ Current$ AND valid charge termination has occurred
	$SBS.Current( ) \leq DF:Quit\ Current$ AND the CHG FET is turned OFF
Clear (0)	$SBS.Current( ) \leq (-) DF:Discharge\ Detection\ Current$
	$SBS.Current( ) \geq DF:Charge\ Detection\ Current$

**FULLY\_CHARGED:** See the *Charge and Discharge Alarms in Gas Gauging, Primary Charge Termination, and Overcharge* functions in the *Charging, 1st Level Safety, and 2nd Level Safety* sections of this data sheet, respectively.

**FULLY\_DISCHARGED:** See the *Charge and Discharge Alarms in Gas Gauging and 1st Level Safety and 2nd Level Safety* sections of this data sheet

ERRORS CODES	EC3...EC0	DESCRIPTION
OK	0x0	The bq20z80 processed the function code with no errors detected.
Busy	0x1	The bq20z80 is unable to process the function code at this time.
Reserved	0x2	The bq20z80 detected an attempt to read or write to a function code reserved by this version of the specification.
		The bq20z80 detected an attempt to access an unsupported optional manufacturer function code.
Unsupported	0x3	The bq20z80 does not support this function code as defined in this version of the specification.
AccessDenied	0x4	The bq20z80 detected an attempt to write to a read-only function code.
Over/Underflow	0x5	The bq20z80 detected a data overflow or underflow.
BadSize	0x6	The bq20z80 detected an attempt to write to a function code with an incorrect data block.
UnknownError	0x7	The bq20z80 detected an unidentifiable error.

### CycleCount( )(0x17)

This read-word function returns, as an unsigned integer value, the number of cycles the battery has experienced, with a range of 0 to 65,534. The default value of *SBS.CycleCount( )* is stored in *DF:Cycle Count* which is updated each time *SBS.CycleCount( )* increments.

If *DF:Operation Cfg B [CCT]* = 0, one cycle = the accumulated discharge of *DF:CC Threshold*.

If *DF:Operation Cfg B [CCT]* = 1, one cycle = the accumulated discharge of *DF:CC %* x *SBS.FullChargeCapacity( )*.

When *SBS.OperationStatus( ) [SS]* = 0 then this function is R/W.

NAME	CLASS / SUBCLASS	FORMAT	VALID RANGE	SIZE (BYTES)	UNITS	DEFAULT VALUE
CC Threshold	SBS Configuration / Data (48)	Integer	0 to 65535	2	mAh	4400
Cycle Count			0 to 65535	2	Counts	0
CC %			0 to 100	1	%	90

**DesignCapacity( ) (0x18)**

This read-word function returns, as an unsigned integer value, the theoretical or nominal capacity of a new pack, stored in *DF:Design Capacity* or in *DF:Design Energy*.

The *SBS.DesignCapacity( )* value is expressed in either current (mAh at a C/5 discharge rate) or power, (10 mWh at a P/5 discharge rate) depending on the setting of *SBS.BatteryMode( ) [CAPACITY\_MODE]*.

When *SBS.OperationStatus( ) [SS] = 0* then this function is R/W.

NAME	CLASS / SUBCLASS	FORMAT	VALID RANGE	SIZE (BYTES)	UNITS	DEFAULT VALUE
Design Capacity	SBS Configuration / Data (48)	Integer	0 to 65535	2	mAh	4400

**DesignVoltage( ) (0x19)**

This read-word function returns an unsigned integer value of the theoretical voltage of a new pack, in mV, with a range of 0 to 65,534. The default value of *SBS.DesignVoltage( )* is in *DF:Design Voltage*.

When *SBS.OperationStatus( ) [SS] = 0* then this function is R/W.

NAME	CLASS / SUBCLASS	FORMAT	VALID RANGE	SIZE (BYTES)	UNITS	DEFAULT VALUE
Design Voltage	SBS Configuration / Data (48)	Integer	7000 to 18000	2	mV	14400

**SpecificationInfo( ) (0x1a)**

This read-word function returns, as an unsigned integer value, the version number of the Smart Battery Specification the battery pack supports, as well as voltage- and current-scaling information.

Power scaling is the product of the voltage scaling times the current scaling. The *SBS.SpecificationInfo( )* is packed in the following fashion:

$$\text{SpecID\_H } 0x10 + \text{SpecID\_L} + (\text{VScale} + \text{IPScale } 0x10) 0x100$$

VScale (voltage scaling) and IPScale (current scaling) should always be set to zero. The default setting of *SBS.SpecificationInfo( )* is in *DF:Spec Info*

When *SBS.OperationStatus( ) [SS] = 0* then this function is R/W.

LABEL	CLASS / SUBCLASS	FORMAT	VALID RANGE	SIZE (BYTES)	UNITS	DEFAULT VALUE
Spec Info	SBS Configuration / Data (48)	Hex	0x0000 to 0xffff	2	Packed	0x0031

FIELD	BITS USED	FORMAT	ALLOWABLE VALUES
SpecID_L	0...3	4-bit binary value	0–15
SpecID_H	4...7	4-bit binary value	0–15
VScale	8...11	4-bit binary value	0 (multiplies voltage by $10^{\text{VScale}}$ )
IPScale	12...15	4-bit binary value	0 (multiplies current by $10^{\text{IPScale}}$ )

**ManufactureDate( ) (0x1b)**

This read-word function returns the date the pack was manufactured in a packed integer. The date is packed in the following fashion:

$$(\text{year}-1980) \times 512 + \text{month} \times 32 + \text{day}$$

The default *SBS.ManufactureDate( )* is in *DF:Manuf Date*.

When *SBS.OperationStatus( ) [SS] = 0* then this function is R/W.

NAME	CLASS / SUBCLASS	FORMAT	VALID RANGE	SIZE (BYTES)	UNITS	DEFAULT VALUE
Manuf Date	SBS Configuration / Data (48)	Integer	0 to 65535	2	Packed	0

FIELD	BITS USED	FORMAT	ALLOWABLE VALUES
Date	0...4	5-bit binary value	0-31 (corresponds to date)
Month	5...8	4-bit binary value	1–12 (corresponds to month number)
Year	9...15	7-bit binary value	0–127 (corresponds to year biased by 1980)

**SerialNumber( ) (0x1c)**

This read-word function is used to return an unsigned integer serial number. The default value of *SBS.SerialNumber( )* is in *DF:Serial Number*.

When *SBS.OperationStatus( ) [SS] = 0* then this function is R/W.

NAME	CLASS / SUBCLASS	FORMAT	VALID RANGE	SIZE (BYTES)	UNITS	DEFAULT VALUE
Serial Number	SBS Configuration / Data (48)	Hex	0x0000 to 0xffff	2	N/A	0

**ManufacturerName( ) (0x20)**

This read-block function returns a character string containing the battery manufacturer's name with a maximum length of 11 characters (11 data + length byte).

The default setting of *SBS.ManufacturerName( )* is in *DF:Manuf Name*. When the bq20z80 is in unsealed or higher security mode, this block is R/W.

NAME	CLASS / SUBCLASS	FORMAT	VALID RANGE	SIZE (BYTES)	UNITS	DEFAULT VALUE
Manuf Name	SBS Configuration / Data (48)	Hex	N/A	11	N/A	Texas Inst.

**DeviceName( ) (0x21)**

This read-block function returns a character string that contains the battery name with a maximum length of 7 characters (7 data + length byte).

The default setting of *SBS.DeviceName( )* is in *DF:Device Name*. When the bq20z80 is in Unsealed or higher security mode, this block is R/W.

NAME	CLASS / SUBCLASS	FORMAT	VALID RANGE	SIZE (BYTES)	UNITS	DEFAULT VALUE
Device Name	SBS Configuration / Data (48)	Hex	N/A	7	N/A	bq20z80

**DeviceChemistry( ) (0x22)**

This read-block function returns a character string that contains the battery chemistry with a maximum length of 4 characters (4 data + length byte).

The default setting of *SBS.DeviceChemistry( )* is in *DF:Device Chemistry* although it has no use for internal charge control or fuel gauging. When the bq20z80 is in Unsealed or higher security mode, this block is R/W.

NAME	CLASS / SUBCLASS	FORMAT	VALID RANGE	SIZE (BYTES)	UNITS	DEFAULT VALUE
Device Chemistry	SBS Configuration / Data (48)	Hex	N/A	4	mV	LION

**ManufacturerData( ) (0x23)**

This read-block function returns several configuration data flash elements with an absolute maximum length of 14 Data + 1 length byte (stored in Manufacturer Data Length). The Manufacturing data elements shown below are stored in the Manufacturer Data (56) subclass of the System Data class. When the bq20z80 is in Unsealed or higher security mode, this block is R/W.

The data available is:

MANUFACTURING DATA		
Lot Code of Pack	Data stored in <i>DF:Pack Lot Code</i> as raw data	2-bytes
Lot Code of PCB	Data stored in <i>DF:PCB Lot Code</i> as raw data	2-bytes
Firmware Version	Data stored in <i>DF:Firmware Version</i> as raw data	1-byte
Hardware Revision	Data stored in <i>DF:Hardware Revision</i> as raw data	1-byte
Cell Revision	Data stored in <i>DF:Cell Revision</i> as raw data	2-bytes
SYSTEM DATA		
Reset Counter Partial	Count	1-byte
Reset Counter Full	Count	1-byte
Reset Counter Watch Dog	Count	1-byte
Check Sum	Number	1-byte

### Authenticate( ) (0x2f)

This read/write-block function allows the host to authenticate the bq20z80-based battery using a SHA-1 authentication transform with a length of 20 data bytes + 1 length byte. See "Battery Authentication using the bq20z80" for further details.

### CellVoltage4( ) - CellVoltage1( ) (0x3c-0x3f)

These read-word functions return an unsigned value of the calculated individual cell voltages, in mV, with a range of 0 to 65,534. *SBS.CellVoltage1( )* corresponds to the bottom series element.

### EXTENDED SBS COMMANDS

These commands are only available when the device is unsealed (*SBS.OperationStatus( ) [SS] = 0*). The standard set of commands is also available when unsealed.

### AFEData( ) (0x45)

This read-block function returns the AFE memory map (9-bytes), beginning with AFE.0x00 as the MSB, and the internal AFE\_Fail\_Counter (2-bytes) returned with a maximum length of 11 data bytes + 1 length byte.

### FETControl( ) (0x46)

This write/read-word function allows direct control of the FETs for test purposes using SMBus commands.

FETStatus( )	bit7	bit6	bit5	bit4	bit3	bit2	bit1	bit0
Low Byte	RSVD	RSVD	RSVD	OD	ZVCHG	CHG	DSG	RSVD

When the bit is set, the FET is turned on. When the bit is cleared, the FET is turned off. The bq20z80 overrides these commands unless in normal gas-gauge operation. The DSG FET does not turn off if charge current is flowing, and the CHG FET does not turn off if discharge current is flowing. This protects the FET body diodes.

**RSVD (bit 0, 5, 6, 7)** Reserved and should be 0

**DSG (bit 1)** Discharge FET Control

**CHG (bit 2)** Charge FET Control

**ZVCHG (bit 3)** Zero-Volt (Pre-Charge) charge FET Control

**OD (bit 4)** bq29312A OD Output Control

### StateOfHealth( ) (0x4f)

This read-word function returns the state of health of the battery which is calculated by the formula: *SBS.FullChargeCapacity( ) / 100 x DF:Design Capacity* or *SBS.FullChargeCapacity( ) / 100 x DF:Design Energy* depending on the setting the *SBS.BatteryMode( ) [CAPACITY]* bit.

### SafetyAlert( ) (0x50)

This read-word function returns indications of pending safety issues, such as when safety timers have started, or fail counters are nonzero but have not reached the required time or value to trigger an *SBS.SafetyStatus( )* change. The bit arrangement follows that of *SBS.SafetyStatus( )*. See the *SBS.SafetyStatus( )* and *1st Level Safety* sections of the data sheet for further details.

### SafetyStatus( ) (0x51)

This read-word function returns the current status of the safety functions.

SafetyStatus( )	bit7	bit6	bit5	bit4	bit3	bit2	bi1	bit0
High Byte	OTD	OTC	OCD	OCC	OCD2	OCC2	PUV	POV
Low Byte	CUV	COV	PF	HWDG	WDF	AOCD	SCC	SCD

**SCD** 1 = Discharge short-circuit fault

**PUV** 1 = Pack undervoltage fault

**SCC** 1 = Charge short-circuit fault

**OCC2** 1 = Tier-2 charge overcurrent fault

**AOCD** 1 = Discharge overcurrent fault

**OCD2** 1 = Tier-2 discharge overcurrent fault

**HWDG** 1 = Host watchdog fault

**OCC** 1 = Charge overcurrent fault

**PF** 1 = Permanent failure flag has been set

**OCD** 1 = Discharge overcurrent fault

**COV** 1 = Cell overvoltage fault

**OTC** 1 = Charge overtemperature fault

**CUV** 1 = Cell undervoltage fault

**OTD** 1 = Discharge overtemperature fault

**POV** 1 = Pack overvoltage fault

**WDF** 1 = AFE watchdog fault

### PFAAlert( ) (0x52)

This read-word function returns indications of pending permanent failure issues, such as when safety timers have started, or fail counters are nonzero, but have not reached the required time or value to trigger a *DF:Permanent Failure Status* change. The bit arrangement follows that of *SBS.PFStatus( )* except for [AFE\_C] and [AFE\_P] as these have no alert. See the *SBS.PFStatus( )*, *DF:PFStatus* and *Secondary Protection Features* sections of the data sheet for further details.

### PFStatus( ) (0x53)

The permanent failure status register indicates the source of the bq20z80 permanent-failure condition. The bit arrangement follows that of *DF:PF Flags 1*. See the *DF:PF Flags 1* and *2nd Level Safety* sections of the data sheet for further details.

When any new cause of PF is detected in *SBS.PFStatus( )*, the new cause is added to *DF:PF Flags 1*. This allows *DF:PF Flag 1* to show ALL of the different PF conditions that have occurred. On the first occasion of *SBS.PFStatus( )* changing from 0x00 the value is stored to *DF:PF Flag 2*.

### OperationStatus( ) (0x54)

This read-word function returns the current status of the operation status of the bq20z80.

OperationStatus( )	bit7	bit6	bit5	bit4	bit3	bit2	bi1	bit0
High Byte	PRES	FAS	SS	CSV	–	Load Mode	–	–
Low Byte	WAKE	DSG	XDSG	XDSGI	–	–	VOK	QEN

**QEN** 1 = QMAX updates are enabled

**VOK** 1 = Voltages are OK for a QMAX update

**XDSGI** 1 = Discharge disabled due to a current issue

**XDSG** 1 = Discharge fault

**DSG** Replica of the *SBS.BatteryStatus( )* [DISCHARGING] bit.

**WAKE** 1 = bq20z80 WAKE mode

- LoadMode** Load mode for Impedance Track modeling. 0 = constant current, 1 = constant power
- CSV** 1 = Data Flash checksum value has been generated
- SS** 1 = Sealed mode
- FAS** 0 = Full access security mode
- PRES** 1 =  $\overline{\text{PRES}}$  is low, indicating that the system is present (battery inserted).

### ChargingStatus( ) (0x55)

This read-word function returns the current status of the charging functions.

ChargingStatus( )	bit7	bit6	bit5	bit4	bit3	bit2	bi1	bit0
High Byte	XCHG	CHGSUSP	PCHG	MCHG	TCHG1	TCHG2	FCHG	PULSE
Low Byte	PULSEOFF	CB	PCMTO	FCMTO	OCHGV	OCHGI	OC	XCHGLV

- XCHG** 1 = Charging disabled
- CHGSUSP** 1 = Charging suspend conditions exist
- PCHG** 1 = Precharging conditions exist
- MCHG** 1 = Maintenance charging conditions exist
- TCHGx** 1 = Temperature-based throttling of *SBS.ChargingCurrent( )* conditions exist
- FCHG** 1 = Fast charging conditions exist
- PULSE** 1 = Pulse charging in progresss
- PULSEOFF** 1 = Pulse charging has turned CHG FET OFF
- CB** 1 = Cell balancing in progress
- PCMTO** 1 = Precharge timeout fault
- FCMTO** 1 = Fast-charge timeout fault
- OCHGV** 1 = Overcharge voltage fault
- OCHGI** 1 = Overcharge current fault
- OC** 1 = Overcharge fault
- XCHGLV** 1 = Battery is depleted

### ResetData( ) (0x57)

This read-word function returns the number of partial resets (low byte) and full resets (high byte) the device has experienced.

### WDRResetData( ) (0x58)

This read-word function returns the number of watchdog resets the device has experienced.

### PackVoltage( ) (0x5a)

This read-word function returns an unsigned integer representing the measured voltage from the AFE pack pin, in mV, with a range of 0 to 65,534.

### AverageVoltage( ) (0x5d)

This read-word function returns a signed integer value that approximates a one-minute rolling average of *SBS.Voltage( )* in mV, with a range of 0 to 65,534.



**UnSealKey( ) (0x60)**

This read/write block (2-words) command allows the user to change the Unseal key for the Sealed-to-Unsealed security-state transition. This function is only available when the bq20z80 is in the Full-Access mode (*SBS.OperationStatus( )*, FAS is clear).

**FullAccessKey( ) (0x61)**

This read/write block (2-words) command allows the user to change the Full-Access security key for the Unsealed-to-Full-Access security-state transition. This function is only available when the bq20z80 is in the Full-Access mode (*SBS.OperationStatus( )*, FAS is clear).

**PFKey( ) (0x62)**

This read/write block (2-words) command allows the user to change the Permanent-Failure-Clear key. This function is only available when the bq20z80 is in the Full Access mode (*SBS.OperationStatus( )*, FA is set).

**ManufacturerInfo( ) (0x70)**

This read-block function returns the data stored in *DF:Manufacturer Info 1...8 (MfgInfo)*, where byte 1 is the MSB with a maximum length of 8 data + 1 length byte. When the bq20z80 is in Unsealed or Full Access mode, this block is R/W.

**SenseResistor( ) (0x71)**

This write-word command allows the user to change the sense resistor value used, in units of  $\mu\Omega$  with a range of 0 to 62535. The bq20z80 automatically updates the respective calibration data on receipt of a new sense resistor value.

**DataFlashClass( ) (0x77)**

This write word command sets the bq20z80 data flash subclass that is to be accessed by the *SBS.DataFlashSubClass( )* commands that follow. These commands only allow access to the configuration data flash locations within the respective labeled subclass. See the *Data Flash Access* section for further details.

A *NACK* is returned to the *SBS.DataFlashClass( )* command if the value of the class is outside of the allowed range. The subclasses are defined in the *Data Flash* section of this data sheet.

**DataFlashSubClass( ) Commands**

These commands are used to access the consecutive 32-byte pages of each subclass.

**NOTE:**

Any DF location deemed Reserved responds with a *NACK* unless the bq20z80 is in the correct security state to allow access.

DataFlashClassSubClass1( ) (0x78)

DataFlashClassSubClass2( ) (0x79)

DataFlashClassSubClass3( ) (0x7a)

DataFlashClassSubClass4( ) (0x7b)

DataFlashClassSubClass5( ) (0x7c)

DataFlashClassSubClass6( ) (0x7d)

DataFlashClassSubClass7( ) (0x7e)

DataFlashClassSubClass8( ) (0x7f)

## DATA FLASH

### CAUTION:

**Care should be taken when mass programming the data flash space using previous versions of data flash memory map files (such as \*.gg files) to ensure all public locations are updated correctly.**

Data Flash can only be updated if  $SBS.Voltage( )$  or  $SBS.PackVoltage( ) \geq DF:Flash Update OK Voltage$ . Data flash reads and writes are verified according to the method detailed in the *2nd Level Safety* section of this data sheet.

Note: Data Flash updates are disabled when  $SBS.SafetyStatus( ) [PF]$  is set.

### Access

In different security modes, the data flash access conditions change. See  $SBS.ManufacturerAccess( )$  for further details.

SECURITY MODE	NORMAL DATA FLASH ACCESS
BootROM	N/A
Full Access	R/W
Unsealed	R/W
Sealed	R

### Data Flash Interface

The bq20z80 data flash is organized into subclasses where each data flash variable is assigned an offset within its numbered subclass. For example: the *DF:Pre-chg Temperature* threshold location is defined as:

- Class = Charge Control
- SubClass = Pre-Charge Config = 33
- Offset = 2

Note: Data Flash commands are NACK'ed if  $SBS.OperationStatus( ) [SS=1]$ .

Each subclass can be addressed individually by using the  $SBS.DataFlashClass( )$  command and the data within each subclass is accessed by using the  $SBS.DataFlashClassSubClassx( )$  commands (0x78..0x7f).

Reading and Writing subclass data are block operations which are 32 Bytes long but data can be written in shorter block sizes. The final block in the subclass can be shorter than 32 bytes so care must be taken as all bytes are overwritten correctly. None of the values written are bounded by the bq20z80 and the values are not rejected by the gas gauge. Writing an incorrect value may result in hardware failure due to firmware program interpretation of the invalid data. The data written is persistent, so a Power On Reset does resolve the fault.

### Reading a SubClass

Information required:

- SubClassID
- Number of bytes in the subclass
- Variable Offset

Procedure:

1. Write the SubClassID using the SMBus Word Write protocol.
  - Command = SubClassAccess command as specified in the data sheet (eg; Command 0x77)
  - Word = SubClassID
2. Read a block of data using SMBus Block Read protocol.
  - Command = DataFlashClassSubClassx as specified in the data sheet (eg; Command 0x78)
  - If a subclass has more than 32 bytes, then to get the next 32 bytes use Command = ReadSubClassCommand+1 (e.g. Command 0x79)

### **Writing a SubClass**

Information required:

- SubClassID
- Number of bytes in the subclass
- 32 bytes of initialized data to be written. Less than 32 bytes is acceptable if a subclass contains less than 32 bytes in the last block.

Procedure:

1. Write the SubClassID using the SMBus Word Write protocol.
  - Command = SubClassAccess command as specified in the data sheet
  - Word = SubClassID
2. Write a block of data using SMBus Block Write protocol.
  - Command = DataFlashClassSubClassx as specified in the data sheet
  - If a subclass has more than 32 bytes, then to get the next 32 bytes, use Command = DataFlashClassSubClassx +1

### **Example**

To write the value of DF:Terminate Voltage to a value of 8.7 V the following sequence is used.

Read complete Gas Gauging-IT Config subclass (SubclassID = 80) into RAM

- Write Subclass ID
  - SMB Slave Address (0x16)
  - SMB CMD 0x77 with 0x0050 as data
- Read Subclass (2 blocks are needed as its over 32 bytes long)
  - SMB Slave Address (0x16)
  - SMB CMD 0x78 receiving 32 bytes of data
  - SMB CMD 0x79 receiving 32 bytes of data

Overwrite offset 38 of received data with 8.7 V

- Update offset 38 with 0x21fc

Write the complete subclass back to the bq20z80

- Write Subclass ID
  - SMB Slave Address (0x16)
  - SMB CMD 0x77 with 0x0050 as data
- Write Subclass
  - SMB Slave Address (0x17)
  - SMB CMD 0x78 with 32 bytes of data
  - SMB CMD 0x79 with 32 bytes of data

Alternatively, only the required block rather than the full subclass can be accessed.

Read required block of Gas Gauging-IT Config subclass (SubclassID = 80) into RAM

- Write Subclass ID
  - SMB Slave Address (0x17)
  - SMB CMD 0x77 with 0x0050 as data
- Read Subclass (2nd block is needed as its offset 38)
  - SMB Slave Address (0x16)
  - SMB CMD 0x79 receiving 32 bytes of data

Overwrite offset (38 - 32 = 6) of received data with 8.7 V

- Update offset 6 with 0x21fc

Write the updated block back to the bq20z80

- Write Subclass ID

- SMB Slave Address (0x17) SMB CMD 0x77 with 0x0050 as data
- Write Subclass
  - SMB Slave Address (0x17)
  - SMB CMD 0x79 with 32 bytes of data

**Table 3. SubClass and Offset Table**

Class/Subclass	SubClassID / Offset	Configurable Value	Size (Bytes) Unsigned Int unless noted
<b>1st Level Safety</b>			
Voltage	0		
	0	COV Threshold	2
	2	COV Time	1
	3	COV Recovery	2
	5	COV Delta	1
	6	COV Temp. Hys	1
	7	POV Threshold	2
	9	POV Time	1
	10	POV Recovery	2
	12	CUV Threshold	2
	14	CUV Time	1
	15	CUV Recovery	2
	17	PUV Threshold	2
	19	PUV Time	1
	20	PUV Recovery	2
Current	1		
	0	OC (1st Tier) Chg	2
	2	OC (1st Tier) Chg Time	1
	3	OC Chg Recovery	Int: 2
	5	OC (1st Tier) Dsg	2
	7	OC (1st Tier) Dsg Time	1
	8	OC Dsg Recovery	2
	10	OC (2nd Tier) Chg	2
	12	OC (2nd Tier) Chg Time	1
	13	OC (2nd Tier) Dsg	2
	15	OC (2nd Tier) Dsg Time	1
	16	Current Recovery Timer	1
	17	AFE OC Dsg	Hex: 1
	18	AFE OC Dsg Time	Hex: 1
	19	AFE OC Dsg Recovery	Hex: 2
	21	AFE SC Chg Config	Hex: 1
	22	AFE SC Dsg Config	Hex: 1
	23	AFE SC Recovery	Hex: 2
Temperature	2		
	0	Over Temp Chg	2
	2	OT Chg Time	1
	3	OT Chg Recovery	2
	5	Over Temp Dsg	2
	7	OT Dsg Time	1
	8	OT Dsg Recovery	2
Host Comm	3		
	0	Host Watchdog Timeout	1
<b>2nd Level Safety</b>			
Voltage	16		
	0	SOV Threshold	2

**Table 3. SubClass and Offset Table (continued)**

Class/Subclass	SubClassID / Offset	Configurable Value	Size (Bytes) Unsigned Int unless noted
	2	SOV Delay	1
	3	Cell Imbalance Current	1
	4	Cell Imbalance Fail Voltage	2
	6	Cell Imbalance Time	1
	7	Battery Rest Time	1
	8	PFIN Detect Time	1
Current	17		
	0	SOC Chg	2
	2	SOC Chg Time	1
	3	SOC Dsg	2
	5	SOC Dsg Time	1
Temperature	18		
	0	SOT Chg	2
	2	SOT Chg Time	1
	3	SOT Dsg	2
	5	SOT Dsg Time	1
	6	Open Thermistor	Int: 2
	8	Open Time	Int: 1
FET Verification	19		
	0	FET Fail Limit	2
	2	FET Fail Time	1
AFE Verification	20		
	0	AFE Check Time	1
	1	AFE Fail Limit	1
	2	AFE Fail Recovery Time	1
	3	AFE Init Retry Limit	1
	4	AFE Init Limit	1
Fuse Verification	21		
	0	Fuse Fail Limit	2
	2	Fuse Fail Time	1
<b>Charge Control</b>			
Charge Inhibit Config	32		
	0	Chg Inhibit Temp Low	Int: 2
	2	Chg Inhibit Temp High	Int: 2
	4	Temp Hys	Int: 2
Pre-Charge Config	33		
	0	Pre-chg Current	2
	2	Pre-chg Temperature	Int: 2
	4	Pre-chg Voltage	2
	6	Recovery Voltage	2
Fast Charge Config	34		
	0	Fast Charge Current	2
	2	Charging Voltage	2
	4	Over Charging Voltage	2
	6	Delta Temp	Int: 2
	8	Suspend Low Temp	Int: 2

**Table 3. SubClass and Offset Table (continued)**

Class/Subclass	SubClassID / Offset	Configurable Value	Size (Bytes) Unsigned Int unless noted
	10	Suspend High Temp	Int: 2
Pulse Charge Config	35		
	0	Turn On Voltage	2
	2	Turn Off Voltage	2
	4	Max ON Pulse Time	1
	5	Min OFF Pulse Time	1
	6	Max Off Voltage	2
Termination Config	36		
	0	Maintenance Current	2
	2	Taper Current	2
	6	Termination Voltage	2
	8	Current Taper Window	2
	10	TCA Set %	Int: 1
	11	TCA Clear %	Int: 1
	12	FC Set %	Int: 1
	13	FC Clear %	Int: 1
Cell Balancing Config	37		
	0	Min Cell Deviation	2
Charging Faults	38		
	0	Over Charging Voltage	2
	2	Overcharge Voltage Time	1
	3	Over Charging Current	2
	5	Overcharge Current Time	1
	6	Overcharge Recovery Current	2
	8	Depleted Voltage	2
	10	Depleted Voltage Time	1
	11	Depleted Recovery	2
	13	Over Charge Capacity	2
	15	Over Chg Recovery	2
	17	FC-MTO	2
	19	PC-MTO	2
	21	Charge Fault Cfg	Hex: 1
<b>SBS Configuration</b>			
Data	48		
	0	Rem Cap Alarm	2
	2	Rem Time Alarm	2
	4	Init Battery Mode	Hex: 2
	6	Design Voltage	2
	8	Spec. Info	Hex: 2
	10	Manuf Date	2
	12	Ser Num	Hex: 2
	14	Cycle Count	2
	16	CC Threshold	2
	18	CC %	1
	19	Design Capacity	2
	21	Design Energy	2

**Table 3. SubClass and Offset Table (continued)**

Class/Subclass	SubClassID / Offset	Configurable Value	Size (Bytes) Unsigned Int unless noted
	23	Manuf Name	String: 12
	35	Device Name	String: 8
	43	Device Chemistry	String: 5
Config	49		
	0	TDA Set %	Int: 1
	1	TDA Clear %	Int: 1
	2	FD Set %	Int: 1
	3	FD Clear %	Int: 1
	4	TDA Volt Threshold	2
	6	TDA Volt Time	1
	7	TDA Recovery	2
	9	FD Volt Threshold	2
	11	FD Volt Time	1
	12	FD Recovery	2
<b>System Data</b>			
Manufacturer Data	56		
	0	Pack Lot Code	Hex: 2
	2	PCB Lot Code	Hex: 2
	4	Firmware Version	Hex: 2
	6	Hardware Revision	Hex: 2
	8	Cell Revision	Hex: 2
Manufacturer Info	58		
	0	Manuf. Info	String: 9
Lifetime Data	59		
	0	Lifetime Max Temp	Int: 2
	2	Lifetime Min Temp	Int: 2
	4	Lifetime Max Cell Voltage	Int: 2
	6	Lifetime Min Cell Voltage	Int: 2
	8	Lifetime Max Pack Voltage	Int: 2
	10	Lifetime Min Pack Voltage	Int: 2
	12	Lifetime Max Chg Current	Int: 2
	14	Lifetime Max Dsg Current	Int: 2
	16	Lifetime Max Chg Pwr	Int: 2
	18	Lifetime Max Dsg Pwr	Int: 2
	22	Life Max AvgDsg Cur	Int: 2
	26	Life Max AvgDsg Pow	Int: 2
	28	Lifetime Avg Temp	Int: 2
Lifetime Temp Samples	60		
	0	LT Temp Samples	4
<b>Configuration</b>			
Registers	64		
	0	Operation Cfg A	Hex: 2
	2	Operation Cfg B	Hex: 2
	4	Permanent Fail Cfg	Hex: 2
	6	Nonremovable Cfg	Hex: 2
<b>LED Support</b>			



**Table 3. SubClass and Offset Table (continued)**

Class/Subclass	SubClassID / Offset	Configurable Value	Size (Bytes) Unsigned Int unless noted
<b>LED</b>	67		
	0	LED Flash Rate	2
	2	LED Blink Rate	2
	4	LED Delay	2
	6	LED Hold Time	1
	7	CHG Flash Alarm	1
	8	CHG Thresh. 1	1
	9	CHG Thresh. 2	1
	10	CHG Thresh. 3	1
	11	CHG Thresh. 4	1
	12	CHG Thresh. 5	1
	13	DSG Flash Alarm	1
	14	DSG Thresh. 1	1
	15	DSG Thresh. 2	1
	16	DSG Thresh. 3	1
	17	DSG Thresh. 4	1
	18	DSG Thresh. 5	1
<b>Power</b>			
Power	68		
	0	Flash Update OK Voltage	2
	2	Shutdown Voltage	2
	4	Shutdown Time	1
	5	Charger Present	2
	7	Sleep Current	2
	9	Bus Low Time	1
	10	Cal Inhibit Temp Low	Int: 2
	12	Cal Inhibit Temp High	Int: 2
	14	Sleep Voltage Time	1
	15	Sleep Current Time	1
<b>Gas Gauging</b>			
IT Config	80		
	0	Load Select	1
	1	Load Mode	1
	41	Term Voltage	Int: 2
	56	User Rate (mA)	Int: 2
	58	User Rate (10 mW)	Int: 2
	60	ReservCap (mAh)	Int: 2
	62	ReservCap (10 mWh)	Int: 2
<b>Current Thresholds</b>	81		
	0	Dsg Current Threshold	2
	2	Chg Current Threshold	2
	4	Quit Current	2
	6	Dsg Relax Time	1
	7	Chg Relax Time	1
<b>State</b>	82		

**Table 3. SubClass and Offset Table (continued)**

Class/Subclass	SubClassID / Offset	Configurable Value	Size (Bytes) Unsigned Int unless noted
	0	Qmax Cell 0	2
	2	Qmax Cell 1	2
	4	Qmax Cell 2	2
	6	Qmax Cell 3	2
	8	Qmax Pack	2
	12	Update Status	Hex: 2
	21	Avg I Last Run	Int: 2
	23	Avg P Last Run	Int: 2
	25	Delta Voltage	Int: 2
<b>Ra Table</b>			
R_a0	88		
	0	Cell0 R_a flag	Hex: 2
	2 to 30	Cell0 R_a 0 to Cell0 R_a 14	Int: 2 each
R_a1	89		
	0	Cell1 R_a flag	Hex: 2
	2 to 30	Cell1 R_a 0 to Cell1 R_a 14	Int: 2 each
R_a2	90		
	0	Cell2 R_a flag	Hex: 2
	2 to 30	Cell2 R_a 0 to Cell2 R_a 14	Int: 2 each
R_a3	91		
	0	Cell3 R_a flag	Hex: 2
	2 to 30	Cell3 R_a 0 to Cell3 R_a 14	Int: 2 each
R_a0x	92		
	0	xCell0 R_a flag	Hex: 2
	2 to 30	xCell0 R_a 0 to xCell0 R_a 14	Int: 2 each
R_a1x	93		
	0	xCell1 R_a flag	Hex: 2
	2 to 30	xCell1 R_a 0 to xCell1 R_a 14	Int: 2 each
R_a2x	94		
	0	xCell2 R_a flag	Hex: 2
	2 to 30	xCell2 R_a 0 to xCell2 R_a 14	Int: 2 each
R_a3x	95		
	0	xCell3 R_a flag	Hex: 2
	2 to 30	xCell3 R_a 0 to xCell3 R_a 14	Int: 2 each
<b>PF Status</b>			
Device Status Data	96		
	0	PF Flags 1	Hex: 2
	2	Fuse Flag	Hex: 2
	4	PF Voltage	2
	6	PF C1 Voltage	2
	8	PF C2 Voltage	2
	10	PF C3 Voltage	2
	12	PF C4 Voltage	2
	14	PF Current	Int: 2
	16	PF Temperature	2
	18	PF Batt Stat	Hex: 2

**Table 3. SubClass and Offset Table (continued)**

Class/Subclass	SubClassID / Offset	Configurable Value	Size (Bytes) Unsigned Int unless noted
	20	PF RC - mAh	Int: 2
	22	PF RC - 10mWh	Int: 2
	24	PF Chg Status	Hex: 2
	26	PF Safety Status	Hex: 2
	28	PF Flags 2	Hex: 2
AFE Regs	97		
	0	AFE Status	Hex: 1
	1	AFE Output	Hex: 1
	2	AFE State	Hex: 1
	3	AFE Function	Hex: 1
	4	AFE Cell Select	Hex: 1
	5	AFE OLV	Hex: 1
	6	AFE OLT	Hex: 1
	7	AFE SCC	Hex: 1
	8	AFE SCD	Hex: 1
<b>Calibration</b>			
Data	104		
	0	CC Gain	Float: 4
	4	CC Delta	Float: 4
	8	Ref Voltage	Int: 2
	10	AFE Corr	Int: 2
	12	AFE Pack Gain	2
	14	CC Offset	Int: 2
	16	Board Offset	Int: 1
	17	Int Temp Offset	Int: 1
	18	Ext1 Temp Offset	Int: 1
	19	Ext2 Temp Offset	Int: 1
Config	105		
	0	CC Current	2
	2	Voltage Signal	2
	4	Temp Signal	2
	6	CC Offset Time	2
	8	ADC Offset Time	2
	10	CC Gain Time	2
	12	Voltage Time	2
	14	Temperature Time	2
	17	Cal Mode Timeout	2
Temp Model	106		
	0	Ext Coef 1	Int: 2
	2	Ext Coef 2	Int: 2
	4	Ext Coef 3	Int: 2
	6	Ext Coef 4	Int: 2
	8	Ext Min AD	Int: 2
	10	Ext Max Temp	Int: 2
	12	Int Coef 1	Int: 2
	14	Int Coef 2	Int: 2

**Table 3. SubClass and Offset Table (continued)**

Class/Subclass	SubClassID / Offset	Configurable Value	Size (Bytes) Unsigned Int unless noted
	16	Int Coef 3	Int: 2
	18	Int Coef 4	Int: 2
	20	Int Min AD	Int: 2
	22	Int Max Temp	Int: 2
Current	107		
	0	Filter	1
	1	Deadband	1
	2	CC Deadband	1
	3	CC Max Deadband	1
	4	CC Deadband Sample	2
	6	CC Max Offset Sample	2

**Operation Cfg A**

OPERATION CONFIGURATION A	bit7	bit6	bit5	bit4	bit3	bit2	bi1	bit0
High Byte	LEDR	LEDRCA	CHGLED	DMODE	LED1	LED0	CC1	CC0
Low Byte	RSVD	RSVD	SLEEP	TEMP1	TEMP0	SLED	ZVCHG1	ZVCHG0

The Operation Cfg bits enable, disable, and configure various features of the bq20z80.

**RSVD** These bits are reserved and **MUST** be programmed to 0.

**ZVCHG0, ZVCHG1** These bits enable or disable the use of ZVCHG or CHG FET for Zero-Volt/Precharge modes.

ZVCHG1	ZVCHG0	FET USED
0	0	ZVCHG
0	1	CHG
1	0	OD
1	1	No Action

**SLED** Enables the bq20z80 display to be used in serial or parallel mode.

0 = Display is in parallel LED mode (default)

1 = Display is in serial LED mode

**TEMP0, TEMP1** These bits select the measurement source used for *SBS.Temperature()*.

TEMP1	TEMP0	TEMPERATURE() SOURCE
0	0	Internal Temperature Sensor
0	1	TS1 Input (default)
1	0	Maximum of TS1 or TS2 Inputs
1	1	Average of TS1 and TS2 Inputs

**SLEEP** Enables the bq20z80 to enter Sleep mode.

0 = bq20z80 never enters Sleep

1 = bq20z80 enters Sleep mode under normal Sleep entry requirements

**CC0, CC1**

These bits configure the bq20z80 for the number of series cells in the battery stack.

CC1	CC0	NUMBER OF SERIES CELLS
0	0	Reserved
0	1	2
1	0	3
1	1	4

**LED0, LED1**

These bits configure the number of LEDs used in the LED Display.

LED1	LED0	NUMBER OF LEDs USED
0	0	User <sup>(1)</sup>
0	1	3
1	0	4
1	1	5

(1) When *User* configuration selected, the LEDs are controlled as shown in the Display Format tables. See Display section of this data sheet for further details.

**DMODE** This bit sets the display as Relative or Absolute mode.

0 = Display reflects *SBS.RelativeStateOfCharge( )*

1 = Display reflects *SBSAbsoluteStateOfCharge( )*

**CHGLED** Enables display while charging.

0 = Display not activated by charging, requires push-button event or SMBus command.

1 = Display active during charging.

**LEDRCA** Enables activation of the LED display when *SBS.BatteryStatus( ) [RCA]* is set.

0 = LED display is not activated when *SBS.BatteryStatus( ) [RCA]* is set.

1 = LED display is activated (simulates a  $\overline{DISP}$  transition) when *SBS.BatteryStatus( ) [RCA]* is set.

**LEDR** Enables activation of the LED display on device-reset exit.

0 = LED display is not activated on exit from device reset.

1 = LED display is activated (simulates a  $\overline{DISP}$  transition) on exit from device reset.

**Operation Cfg B**

OPERATION CONFIGURATION B	bit7	bit6	bit5	bit4	bit3	bit2	bit1	bit0
High Byte	PFD1	PFD0	RESCAP	NCSMB	NRCHG	CSYNC	CHGTERM	CCT
Low Byte	CHGSUSP	OTFET	CHGFET	CHGIN	NR	CPE	HPE	BCAST

**BCAST** This bit enables or disables SBS broadcasts to smart charger and host.

0 = Broadcasts to host and charger disabled

1 = Broadcasts to host and charger enabled

**HPE** This bit enables or disables PEC transmissions to the smart-battery host for master-mode alarm messages.

0 = No PEC byte on alarm warning to host

1 = PEC byte on alarm warning to host

- CPE** This bit enables or disables PEC transmissions to the smart-battery charger for master-mode alarm messages.
- 0 = No PEC byte on alarm warning to charger  
1 = PEC byte on alarm warning to charger
- NR** This bit can set the bq20z80 in non-removable battery mode and determines the recovery method for current based Primary Protection features.
- 0 = Removable battery mode  
1 = Non-removable battery mode
- CHGIN** This bit can set enable the CHG FET (and ZVCHG FET if used) to turn off when the bq20z80 is in charge-inhibit mode.
- 0 = No FET change in charge-inhibit mode.  
1 = Charge and ZVCHG, if used, turn off in charge-inhibit mode.
- CHGFET** This bit enables or disables the CHG FET from reacting to a valid charge termination.
- 0 = CHG FET stays on at charge termination.  
1 = CHG FET turns off at charge termination.
- OTFET** This bit enables or disables FET actions from reacting to an overtemperature fault.
- 0 = There is NO FET action when an overtemperature condition is detected.  
1 = When *SBS.SafetyStatus( ) [OTC]* is set then the CHG FET is turned off and when *SBS.SafetyStatus( ) [OTD]* is set then the DSG FET is turned off
- CHGSUSP** This bit can enable the CHG FET (and ZVCHG FET if used) to turn off when the bq20z80 is in Charge Suspend mode.
- 0 = No FET change in Charge Suspend mode.  
1 = Charge and ZVCHG, if used, turns off in Charge Suspend mode.
- CCT** This bit sets the format of the Cycle Count Threshold.
- 0 = *DF:Cycle Count* is a fixed mAh value.  
1 = *DF:Cycle Count* is in % of *SBS.FullChargeCapacity( )*.
- CHGTERM** This bit enables or disables *SBS.BatteryStatus( ) [TCA, FC]* to be cleared after charger termination confirmed.
- 0 = *SBS.BatteryStatus( ) [TCA, FC]* are not cleared by charge termination confirmation, but are cleared by other means.  
1 = *SBS.BatteryStatus( ) [TCA, FC]* are cleared when *SBS.Current( ) < DF:Chg Current Threshold* for a period of  $2 \times DF:Current Taper Window$ . Note: This does not disable clearing by *DF:TCA\_Clear* and *DF:FC\_Clear*.
- CSYNC** Enables the bq20z80 to write *SBS.RemainingCapacity( )* to equal *SBS.FullChargeCapacity( )* when a valid charge termination is detected.

- 0 = *SBS.RemainingCapacity( )* is not modified on valid charge termination
- 1 = *SBS.RemainingCapacity( )* is written up to equal *SBS.FullChargeCapacity( )* on valid charge termination .

**NRCHG** Enables the charge FET to remain on during sleep when *DF:Operation Cfg B [NR]* is set

- 0 = Charge FET turns off in Sleep (default)
- 1 = Charge FET remains on in Sleep

**NCSMB** Enables extended SMBUS  $t_{\text{TIMEOUT}}$

- 0 = Normal SMBUS  $t_{\text{TIMEOUT}}$  (default)
- 1 = Extended SMBUS  $t_{\text{TIMEOUT}}$

**RESCAP** This bit configures the compensation model for the *DF:Reserve Cap-mAh* and *DF:Reserve Cap-10mWh*.

- 0 = Light Load (C/20) Compensation
- 1 = *SBS.AverageLoad( )* Compensation

**PFD1,0** Configure the Permanent Failure LED display (disabled if *SBS.Operation Cfg A [SLED] = 1*)

PFD1	PFD0	OPERATION
0	0	PF Display not available
0	1	PF Display is activated after SOC display if $\overline{\text{DISP}}$ is held low for $t_{\text{LED\_HOLD}}$
1	0	PF Display not available
1	1	PF Display is automatically activated after SOC display

### Nonremovable Configuration

NONREMOVABLE CONFIGURATION	bit7	bit6	bit5	bit4	bit3	bit2	bi1	bit0
High Byte	–	–	OCD	OCC	OCD2	OCC2	–	–
Low Byte	–	–	–	–	–	AOCD	SCC	SCD

The *DF:Non-Removable Cfg* bits enable the current protection recovery features to be treated differently based on *DF:Operation Cfg A [NR]*. The additional recovery features are detailed with the individual features in the *1st Level Safety* section of this data sheet.

- SCD** = Short Circuit in Discharge
- SCC** = Short Circuit in Charge
- AOCD** = AFE Overcurrent in Discharge
- OCC2** = Overcurrent in Charge - Tier 2
- OCD2** = Tier-2 Overcurrent, Discharge
- OCC** = Overcurrent in Charge
- OCD** = Overcurrent in Discharge

### PF Flags 1

The permanent failure flags 1 register indicates the reason that bq20z80 has entered permanent failure.

PF FLAGS 1	bit7	bit6	bit5	bit4	bit3	bit2	bi1	bit0
High Byte	FBF	–	–	SOPT	SOCD	SOCC	AFE_P	AFE_C

PF FLAGS 1	bit7	bit6	bit5	bit4	bit3	bit2	bi1	bit0
Low Byte	DFF	DFETF	CFETF	CIM	SOTD	SOTC	SOV	PFIN

<b>PFIN</b>	Set on External Input Indication of permanent failure
<b>SOV</b>	Set on a Safety-Overvoltage permanent failure
<b>SOTC</b>	Set on a Charge Safety Overtemperature permanent failure
<b>SOTD</b>	Set on a Discharge Safety Overtemperature permanent failure
<b>CIM</b>	Set on a Cell-Imbalance permanent failure
<b>CFETF</b>	Set on a Charge-FET-Failure permanent failure
<b>DFETF</b>	Set on a Discharge-FET-Failure permanent failure
<b>DFF</b>	Set on a Data Flash Fault permanent failure
<b>AFE_C</b>	Set on an AFE-Communications permanent failure
<b>AFE_P</b>	Set on a Periodic-AFE-Communications permanent failure
<b>SOCC</b>	Set on a Charge Safety-Overcurrent permanent failure
<b>SOCD</b>	Set on a Discharge Safety Overcurrent in permanent failure
<b>SOPT</b>	Set on an Open Thermistor permanent failure
<b>FBF</b>	Set when the fuse has not cut off current, even though the output has been driven low

### Permanent Fail Cfg

The Permanent Failure Configuration register enables or disables the use of the  $\overline{\text{SAFE}}$  and  $\overline{\text{SAFE}}$  pins when the corresponding *DF:PF Flags 1* flag is set.

PERMANENT FAILURE CFG	bit7	bit6	bit5	bit4	bit3	bit2	bi1	bit0
High Byte	–	–	–	–	XSOCD	XSOCC	XAFE_P	XAFE_C
Low Byte	XDFF	XDFETF	XCFETF	XCIM	XSOTD	XSOTC	XSOV	XPFIN

If corresponding *DF:PF Flags 1* AND *DF:Permanent Fail Cfg* bits are set (1), the  $\overline{\text{SAFE}}$  output is driven and latched low and the  $\overline{\text{SAFE}}$  output is driven and latched high. This does not include *DF:PF Flags 1* [FBF].

### Lifetime Data

**Lifetime Maximum Temperature:** This data flash value is updated if the current *SBS.Temperature( )* is > the current *DF:Lifetime Max Temp* value for a time > 60s OR an increment > 1.0°C.

**Lifetime Minimum Temperature:** This data flash value is updated if the current *SBS.Temperature( )* is < the current *DF:Lifetime Min Temp* value for a time > 60s, OR an increment > 1.0°C.

**Lifetime Maximum Cell Voltage:** This data flash value is updated if any *SBS.CellVoltage( )* is > the current *DF:Lifetime Max Cell Voltage* value for a time > 60s, OR an increment > 25 mV.

**Lifetime Minimum Cell Voltage:** This data flash value is updated if the current *SBS.CellVoltage( )* is < the current *DF:Lifetime Min Cell Voltage* value for a time > 60s, OR an increment > 25 mV.

**Lifetime Maximum Pack Voltage:** This data flash value is updated if the current *SBS.Voltage( )* is > the current *DF:Lifetime Max PackVoltage* value for a time > 60s, OR an increment > 100 mV.

**Lifetime Minimum Pack Voltage:** This data flash value is updated if the current *SBS.Voltage( )* is < the current *Lifetime Min Pack Voltage* value for a time > 60s, OR an increment > 100 mV.

**Lifetime Maximum Charge Current:** This data flash value is updated if the current *SBS.AverageCurrent( )* is > the current *DF:Lifetime Max Chg Current* value, and *SBS.AverageCurrent( )* is positive (charge) for a time > 60s, OR an increment > 100 mA.

**Lifetime Maximum Discharge Current:** This data flash value is updated if the current *SBS.AverageCurrent( )* is > the current *DF:Lifetime Max Dsg Current* value, and *SBS.AverageCurrent( )* is negative



(discharge) for a time > 60s, OR an increment > 100 mA.

**Lifetime Maximum Charge Power:** This data flash value is updated when *SBS.AveragePower( )* is > the current *DF:Lifetime Max Chg Power* value for a time > 60s, OR an increment > 1000 mW.

**Lifetime Maximum Discharge Power:** This data flash value is updated when *SBS.AveragePower( )* is > the current *DF:Lifetime Max Dsg Power* value for a time > 60s, OR an increment > 1000 mW.

**Lifetime Average Temperature:** *DF:Lifetime Avg Temp* is updated when the average of *SBS.Temperature( )* exceeds the range of the present value by  $\pm 1^\circ\text{C}$ . The average is calculated as a simple average of all the valid temperature readings.

When any of the Lifetime data value is triggered to be updated then **ALL** Lifetime data is updated to data flash. However, no Lifetime Data is updated until *SBS.StatusUpdate( ) [ITEN]* is set.

NAME	CLASS / SUBCLASS	FORMAT	VALID RANGE	SIZE (BYTES)	UNITS	DEFAULT VALUE
Lifetime Max Temp	System Data / Lifetime Data (59)	Signed Int	0 to 1400	2	0.1°C	0
Lifetime Min Temp			-600 to 1400			1400
Lifetime Avg Temp			-600 to 1400			0
Lifetime Max Dsg Current			0 to 65,345		mA	0
Lifetime Max Chg Current			0 to 65,345			0
Lifetime Max Pack Voltage			0 to 65,345		mV	0
Lifetime Min Pack Voltage			0 to 65,345			20,000
Lifetime Max Cell Voltage			0 to 65,345			0
Lifetime Min Cell Voltage			0 to 65,345			10,000
Lifetime Max Dsg Power			0 to 65,345		10 mWh	10,000
Lifetime Max Chg Power			0 to 65,345			0
LT Temp Samples			System Data / Lifetime Temp Samples (60)		Integer	0 to 140,000,000

## CHARGE CONTROL

### CC-CV Charging

**SBS.ChargingCurrent( ) (0x14)** Read only, 16-bit unsigned integer word, units in mA. Reports the appropriate charging current per the charging algorithm in this section. The default value is set in *DF:Fast Charge Current*, and altered per the algorithm or safety conditions.

**SBS.ChargingVoltage( ) (0x15)** Read only, 16-bit unsigned integer word, units in mV. Reports the appropriate charging voltage per the charging algorithm in this section. The default value is set in *DF:Fast Charge Voltage*, and altered per the charging algorithm or safety condition.

NAME	CLASS / SUBCLASS	FORMAT	VALID RANGE	SIZE (BYTES)	UNITS	DEFAULT VALUE
Fast Charge Current	Charging / Fast Charge Config. (34)	Integer	0 to 10000	2	mA	4000
Fast Charge Voltage		Integer	0 to 20000	2	mV	16800

### Charge Inhibit Mode

The bq20z80 sets the *SBS.ChargingCurrent( )* and *SBS.ChargingVoltage( )* values to 0 to inhibit charging when *SBS.Temperature( )* < *DF:Charge Inhibit Temp Low* OR > *DF:Charge Inhibit Temp High*. When charging is inhibited, *SBS.ChargingStatus( ) [XCHG]* is set.

If *DF:Operation Cfg B [CHGIN]* is set, the CHG FET and ZVCHG FET (if used) are turned off when the bq20z80 is in charge-inhibit mode.

The bq20z80 allows charging to resume when *SBS.Temperature( )*  $\geq$  *DF:Charge Inhibit Temp Low* + *DF:Temp Hys* AND is  $\leq$  *DF:Charge Inhibit Temp High*–*DF:Temp Hys*. The FETs also return to their previous states at this time.

*SBS.ChargingStatus( ) [XCHG]* is cleared when these conditions are met, or when a fault condition is detected, or when the battery is removed if *DF:Operation Cfg B [NR]* is cleared.

NAME	DESCRIPTION	FORMAT	VALID RANGE	SIZE (BYTES)	UNITS	DEFAULT VALUE
Charge Inhibit Temp Low	Charge Control / Charge Inhibit Config (32)	Signed Int	-400 to 1200	2	0.1°C	0
Charge Inhibit Temp High			-400 to 1200	2		450
Temp Hys			0 to 100	1		10

**Precharge Mode**

The bq20z80 sets *SBS.ChargingCurrent( )* to *DF:Pre-chg Current* when *SBS.Temperature( )* is  $\geq$  *DF:Charge Inhibit Temp Low*, AND is  $<$  *DF:Pre-chg Temp*, OR if any *SBS.CellVoltage<sub>x</sub>( )* is  $<$  *DF:Pre-chg Voltage*. Depending on the setting of *DF:Operation Cfg A [ZVCHG1, ZVCHG0]* FET action may be taken. Precharge mode is also entered if any of *SBS.SafetyStatus( ) [CUV, PUV, OCD or OCD2]* are set.

ZVCHG1	ZVCHG0	FET USED
0	0	ZVCHG
0	1	CHG
1	0	OD Pin
1	1	No Action

During precharge *SBS.Charging Status( ) [PCHG]* is set, and is cleared when *SBS.Temperature( )* is  $\geq$  *DF:Pre-chg Temp + DF:Temp Hys*, AND all *SBS.CellVoltage<sub>x</sub>( )*  $\geq$  *DF:Recovery Voltage*, or Charge Suspend is entered, a fault condition detected, or the battery removed if *DF:Operation Cfg B [NR]* is cleared.

NAME	DESCRIPTION	FORMAT	VALID RANGE	SIZE (BYTES)	UNITS	DEFAULT VALUE
Pre-chg Temp	Charge Control / Pre-Charge Config (33)	Signed Int	-400 to 1200	2	0.1°C	120
Pre-chg Voltage			0 to 20000		mV	3000
Recovery Voltage		Integer	0 to 20000		mV	3100
Pre-chg Current			0 to 2000		mA	250

**Fast Charge**

The bq20z80 sets *SBS.ChargingCurrent( )* to *DF:Fast Charge Current* and *SBS.ChargingVoltage( )* to *DF:Fast Charge Voltage* when the following are true.

- *SBS.Temperature( )*  $\geq$  *DF:Pre-chgTemp*
- *SBS.Temperature( )*  $<$  *DF:Charge Suspend Temp High - (2 x DF:Delta Temp)*
- *SBS.CellVoltage<sub>x</sub>( )*  $\geq$  *DF:Pre-chg Voltage*
- *SBS.Voltage( )*  $\leq$  *SBS.ChargingVoltage( ) + DF:Over Charging Voltage*

See the *Charging Faults* section for further details. During fast charge, *SBS.ChargingStatus( ) [FCHG]* is set and the CHG FET is turned on if no protection conditions are detected.

NAME	CLASS / SUBCLASS	FORMAT	VALID RANGE	SIZE (BYTES)	UNITS	DEFAULT VALUE
Fast Charge Voltage	Charge Control / Fast Charge Config (34)	Integer	0 to 2,0000	2	mV	16,800
Fast Charge Current			0 to 10,000	2	mA	4000
Over Charging Voltage			0 to 2000	2	mV	500

**Fast Charge Temperature Throttling**

The bq20z80 alters *SBS.ChargingCurrent( )* and sets *SBS.ChargingStatus( ) [TCHG2, TCHG1]* during fast charge in response to changing temperature conditions. If *SBS.Temperature( )* is  $\leq$  *DF:Charge Suspend Temp High* AND is  $\geq$  *DF:Charge Suspend Temp High - DF:DeltaTemp*, then *SBS.ChargingCurrent( )* is set to *DF:Pre-chg Current* and *SBS.ChargingStatus( ) [TCHG1]* is set.

If *SBS.Temperature( )* is  $<$  *DF:Charge Suspend Temp High - DF:Delta Temp*, AND is  $\geq$  *DF:Charge Suspend Temp High - (2 x DF:DeltaTemp)*, *SBS.ChargingCurrent( )* is set to  $(DF:Fast Charge Current - DF:Pre-chg Current) / 2$ , and *SBS.ChargingStatus( ) [TCHG2]* is set.

If *SBS.Temperature( )* is  $<$  *DF:Charge Suspend Temp High - (2 x DF:Delta Temp)* AND is  $\geq$  *DF:Pre-Chg Temp*, *SBS.ChargingCurrent( )* is set to *DF:Fast Charge Current*, and *SBS.ChargingStatus( ) [TCHG2, TCHG1]* are cleared.

When transitioning from [FCHG] to [TCHG2] or from [TCHG2] to [TCHG1] there is additional temperature hysteresis of *DF:Temp Hys*.

*SBS.ChargingStatus( )* [TCHG2, TCHG1] are also cleared when another charging mode is entered, a protection condition is detected, or the battery is removed while the *DF:Operation Cfg B [NR]* is set.

However, if *DF:DeltaTemp* is set to 0, *SBS.ChargingCurrent( )* remains *DF:Fast Charge Current* during fast charge.

NAME	CLASS / SUBCLASS	FORMAT	VALID RANGE	SIZE (BYTES)	UNITS	DEFAULT VALUE
Delta Temp	Charge Control / Fast Charge Config (34)	Integer	0 to 500		0.1°C	50

### Charge Suspend Mode

If charging has begun, the bq20z80 suspends charging when:

- *SBS.AverageCurrent( )* is > the *DF:Chg Current Threshold*, AND
- *SBS.Temperature( )* is < *DF:Charge Suspend Temp Low* AND is > *DF:Charge Suspend Temp High*.

If *DF:Operation Cfg B [CHGSUSP]* is set, the CHG FET and ZVCHG FET (if used), are turned off when the bq20z80 is in charge-suspend mode.

When charging is suspended, *SBS.ChargingCurrent( )* is set to 0, and *SBS.ChargingStatus( ) [CHGSUSP]* is set.

To return to normal charging, *SBS.Temperature( )* must be:

- $\geq$  *DF:Charge Inhibit Temp Low + DF:Temp Hys*, AND
- $\leq$  *DF:Charge Inhibit Temp High - DF:Temp Hys*.

The bq20z80 clears *SBS.ChargingStatus( ) [CHGSUSP]* when this condition is met, and sets *SBS.ChargingCurrent( )* according to the appropriate charging mode entered. The FETs are also returned to their previous state at this time.

*SBS.ChargingStatus( ) [CHGSUSP]* is also cleared when a protection condition is detected, or when the battery is removed while *DF:Operation Cfg B [NR]* is cleared.

NAME	CLASS / SUBCLASS	FORMAT	VALID RANGE	SIZE (BYTES)	UNITS	DEFAULT VALUE
Charge Suspend Temp Low	Charge Control / Fast Charge Config (34)	Signed Int	-400 to 1200	2	0.1°C	-50
Charge Suspend Temp High			-400 to 1200			550

### Pulse Charging

Pulse charging is part of the fast-charging mode and is a loop. During the loop, the measured cell voltages are calculated every 250 ms. This data is not reported via the *SBS.CellVotagex( )* commands.

The pulse-charging loop is entered when the maximum cell voltage is  $\geq$  *DF:Max OFF Voltage*, OR maximum cell voltage is  $\geq$  *DF:Turn OFF Voltage* for *DF:Max ON Pulse Time*. When these conditions are met, the CHG FET is turned off, and the *SBS.ChargingStatus( ) [PULSE. PULSE\_OFF]* are set.

If the maximum cell voltage is < *DF:Turn ON Voltage*, AND the CHG FET is off for *DF:Min OFF Pulse Time*, the CHG FET is turned on and *SBS.ChargingStatus( ) [PULSE\_OFF]* cleared.

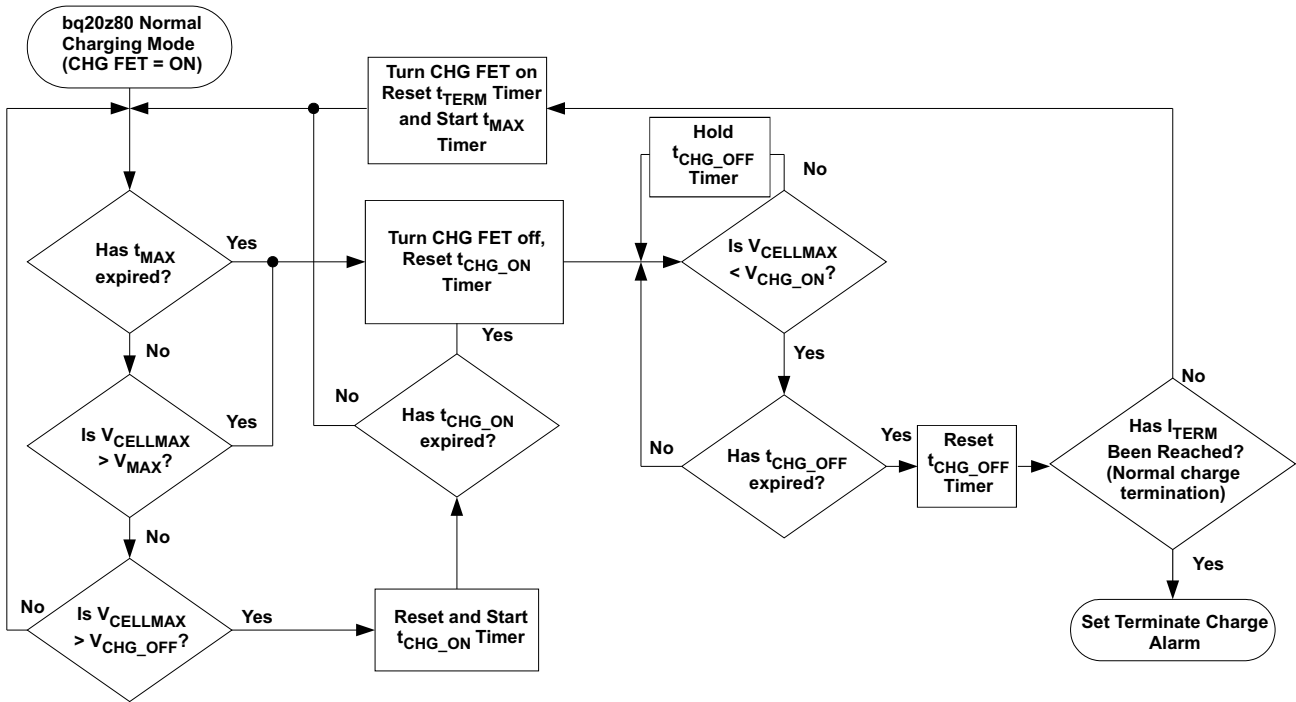

Figure 3. Pulse Charging

The pulse-charging loop is exited and *SBS.ChargingStatus( ) [PULSE]* is cleared if another charging mode is entered, a protection condition detected, or the battery is removed when *DF:Operation Cfg B [NR]* is cleared.

NAME	CLASS / SUBCLASS	FORMAT	VALID RANGE	SIZE (BYTES)	UNITS	DEFAULT VALUE
Turn ON Voltage	Charge Control / Pulse Charge Config (35)	Integer	0 to 5000	2	mV	4150
Turn OFF Voltage			0 to 5000			4250
Max ON Pulse Time			0 to 240	1	s/4	240
Max OFF Pulse Time			0 to 240			0
Max OFF Voltage			0 to 5000	2	mV	4270

### Cell Balancing

The bq20z80 uses the unique ability of Impedance Track™ technology to determine the chemical state of charge of each cell. The cell balancing algorithm used in the bq20z80 causes the differences in the cells state of charge in the fully charged state to gradually decrease, which prevents high cells from overcharge causing their excessive degradation, and increases overall pack energy by preventing too early charge termination. This is achieved by calculating the differences in the required amount of charge for each cell from its present state until the cell is fully charged. For cells that require less charge to reach full, the difference in charge from those cell requiring more charge to reach full (dQ) is by-passed during charging by turning ON bypass FETs in bq29312A AFE for a predefined time. When any bypass FET is turned on, then *SBS.ChargingStatus( ) [CB]* is set; otherwise, *SBS.ChargingStatus( ) [CB]* is cleared.

Note: If *DF:Min Cell Deviation* is 0, then no bypass FETs are turned ON and cell balancing is disabled.

The bypass time needed for each cell is calculated as

$$\text{Bypass time} = dQ \times R / (V \times \text{duty\_cycle}).$$

Where, R is the value of the bypass resistance that can be calculated by adding the internal bypass FET resistor value of 500 Ω (typ) to the two series input filter resistors ( $R_{\chi}$ ) of bq29312A and corresponding cells. For example: an input filter  $R_{\chi}$  value of 100 Ω,  $R = 500 + 100 \times 2 = 700 \Omega$ .

The value of resistances used is accounted for in *DF:Min Cell Deviation* with units on s/mAh and is calculated by:

*DF:Min Cell Deviation* =  $(500 + (2 \times R_{\chi}) \Omega) / 0.4 \times 3.6V$ , giving a default of 1750.

NAME	CLASS / SUBCLASS	FORMAT	VALID RANGE	SIZE (BYTES)	UNITS	DEFAULT VALUE
Min Cell Deviation	Charge Control / Cell Balancing (37)	Integer	0 to 65535	2	s/mAh	1750

### Primary Charge Termination

The bq20z80 determines charge termination when the average *SBS.Current()* during 2 consecutive periods of *DF:Current Taper Window* is  $< DF:Taper Current$  AND during the 2 consecutive periods of *DF:Current Taper Window* the accumulated change in capacity must be  $> 0.25mAh$ . If *DF:TCA\_Set* = -1 the *SBS.BatteryStatus()*[TCA] will be set when charge termination is detected. If *DF:FC\_Set* = -1 the *SBS.BatteryStatus()*[FC] will be set when charge termination is detected. If *DF:Operation Cfg B [CHGFET]* is set, the CHG FET is also turned off. For a valid charge termination to occur *SBS.Voltage()* + *DF:Termination Voltage* must also be  $\geq DF:Fast Charge Voltage$ .

When charge termination is detected and if *DF:TCA\_Set* = -1, *SBS.ChargingStatus()* [MCHG] is set, and *SBS.ChargingCurrent()* is set to *DF:Maintenance Charge Current*.

If *DF:Operation Cfg B [CSYNC]* is set then *SBS.RemainingCapacity()* is updated with the value in *SBS.FullChargeCapacity()* regardless of the setting of *DF:TCA\_Set*.

*SBS.BatteryStatus()* [FC] is cleared and *SBS.ChargingCurrent()* is set to the appropriate value for battery conditions when *SBS.RelativeStateOfCharge()* is  $< DF:FC Clear \%$ .

*SBS.BatteryStatus()* [TCA] is also cleared, and *SBS.ChargingCurrent()* is set to the appropriate value for battery conditions when *DF:Operation Cfg B [CHGTERM]* is set, AND *SBS.Current()* is  $< DF:Chg Current Threshold$  for two consecutive periods of *DF:Current Taper Window*.

NAME	CLASS / SUBCLASS	FORMAT	VALID RANGE	SIZE (BYTES)	UNITS	DEFAULT VALUE
Maintenance Charge Current	Charge Control / Termination Config. (36)	Integer	0 to 1000	2	mA	0
Taper Current			0 to 1000	2		250
Termination Voltage			0 to 1000	2	mV	300
Current Taper Window			0 to 60	1	s	40

### Charge Control SMBus Broadcasts

All broadcasts are enabled by setting *DF:Operation Cfg B [BCAST]*. If *DF:Operation Cfg B [HPE]* is set, the Master-Mode broadcasts to the Host address have PEC enabled, and if *DF:Operation Cfg B [CPE]* is set, the Master-Mode broadcasts to the Smart-Charger address have PEC enabled.

If enabled, *SBS.ChargingVoltage()* and *SBS.ChargingCurrent()* is broadcast to the Smart-Charger address between every 10 and 60 seconds.

If enabled, *SBS.AlarmWarning()* is broadcast to the Host address every 10 seconds, only while any of the *SBS.BatteryStatus()*, bits 8 -15, are set. Broadcasting stops when *SBS.BatteryStatus()*, 8-15, are clear.

If enabled, *SBS.AlarmWarning()* is broadcast to the Smart Charger address every 10 seconds only when any of *SBS.BatteryStatus()*, bits 11 -15. Broadcasting stops when *SBS.BatteryStatus()*, 11-15, are clear.

### Charging Faults

#### Charge Fault Cfg

CHARGE FAULT CONFIGURATION	bit7	bit6	bit5	bit4	bit3	bit2	bit1	bit0
Low Byte	–	–	PCMTO	FCMTO	OCHGV	OCHGI	OC	XCHGLV

The *DF:Charge Fault Cfg* bits enable FET action to take place when a fault occurs. See the following details within this section for selecting the appropriate settings.

### Battery Depleted

The bq20z80 sets *SBS.ChargingStatus( ) [XCHGLV]* when the charger is present AND *SBS.Voltage( )* is  $\leq DF:Depleted Voltage$  for period  $\geq DF:Depleted Voltage Time$ .

When this fault is detected, *SBS.ChargingCurrent( )* is set to 0, *SBS.BatteryStatus( ) [TDA]* is set and if *DF:Charge Fault Cfg [XCHGLV]* is set then the DSG FET is turned off and the CHG and ZVCHG FETs controlled per the configuration of *DF:Operation Cfg A [ZVCHG1, ZVCHG0]*.

To recover from this mode *SBS.Voltage( )* must become  $\geq DF:Depleted Recovery$ . When the bq20z80 recovers from a Battery Depleted state, the DSG, CHG, and ZVCHG FETs are returned to the previous state in accordance with the charging algorithm and *DF:Operation Cfg, A [ZVCHG1, ZVCHG0]* and *SBS.BatteryStatus( ) [TCA]* and *SBS.ChargingStatus( ) [XCHGLV]* are reset.

NAME	CLASS / SUBCLASS	FORMAT	VALID RANGE	SIZE (BYTES)	UNITS	DEFAULT VALUE
Depleted Voltage	Charging Control / Charging Faults (38)	Integer	0 to 16,000	2	mV	8000
Depleted Voltage Time			0 to 60	1	s	2
Depleted Recovery			0 to 16,000	2	mV	8500

### Overcharging Voltage

The bq20z80 sets *SBS.ChargingStatus( ) [OCHGV]* when *SBS.Voltage( )*  $\geq SBS.ChargingVoltage( ) + DF:Over Charging Voltage$  for a period  $\geq DF:Over Charging Volt Time$ . If *DF:Over Charging Volt Time* = 0, this feature is completely disabled.

When *DF:Charge Fault Cfg [OCHGV]* is set, then the CHG and ZVCHG FETs are turned off. Also, *SBS.ChargingCurrent( )* and *SBS.ChargingVoltage( )* are cleared to 0, and *SBS.BatteryStatus( ) [TCA]* is set.

To recover from this mode, *SBS.Voltage( )* must become  $\leq DF:Fast Charge Voltage$ . When the bq20z80 recovers from an Overcharging Voltage state, the CHG and ZVCHG FETs are returned to the previous state in accordance with the charging algorithm, and *SBS.BatteryStatus( ) [TCA]* is reset. *SBS.ChargingCurrent( ) [OCHGV]* and *SBS.ChargingVoltage( )* are not reset via this recovery.

If *SBS.Voltage( )*  $\leq SBS.ChargingVoltage( )$  then *SBS.ChargingCurrent( )*, *SBS.ChargingVoltage( )*, and the CHG and ZVCHG FETs are returned to the previous state in accordance with the charging algorithm, and *DF:Operation Cfg A [ZVCHG1, ZVCHG0]* and *SBS.BatteryStatus( ) [TCA]* are reset.

NAME	CLASS / SUBCLASS	FORMAT	VALID RANGE	SIZE (BYTES)	UNITS	DEFAULT VALUE
Over Charging Voltage	Charging Control / Charging Faults (38)	Integer	0 to 3000	2	mV	500
Over Charging Volt Time		Integer	0 to 60	1	s	2

### Overcharging Current

The bq20z80 sets *SBS.ChargingStatus( ) [OCHGI]* when *SBS.Current( )* is  $\geq SBS.ChargingCurrent( ) + DF:Over Charging Current$  for a period of *DF:Over Charging Curr Time*. If *DF:Over Charging Curr Time* = 0, then feature is completely disabled.

When *DF:Charge Fault Cfg [XOCHGI]* is set, then the CHG FET is turned OFF and ZVCHG FET is turned ON if *DF:Operation Cfg A [ZVCHG1, ZVCHG0]* are set appropriately. Also, *SBS.ChargingCurrent( )* and *SBS.ChargingVoltage( )* are cleared to 0, and *SBS.BatteryStatus( ) [TCA]* is set.

To recover from this mode, *SBS.AverageCurrent( )* must be  $\leq DF:Over Charging Curr Recov$ . When the bq20z80 recovers from an Overcharging Current state, then *SBS.ChargingCurrent( )*, *SBS.ChargingVoltage( )*, and the CHG and ZVCHG FE's are returned to previous state in accordance with the charging algorithm and *DF:Operation Cfg A [ZVCHG1, ZVCHG0]*. *SBS.BatteryStatus( ) [TCA]* and *SBS.ChargingStatus( ) [OCHGI]* are cleared.

NAME	CLASS / SUBCLASS	FORMAT	VALID RANGE	SIZE (BYTES)	UNITS	DEFAULT VALUE
Over Charging Current	Charging Control / Charging Faults (38)	Integer	0 to 2000	2	mA	500
Over Charging Curr Time			0 to 60	1	s	2
Over Charging Curr Recov			0 to 2000	2	mA	100

### Overcharge

The bq20z80 sets *SBS.ChargingStatus()* [OC] when the amount of capacity added after the point where *SBS.RemainingCapacity()* is  $> \text{SBS.FullChargeCapacity}() + \text{DF:Over Charge Capacity}$ . If *DF:Over Charge Capacity* is set to 0, this feature is completely disabled.

When *DF:Charge Fault Cfg* [XOCHG] is set, then the CHG FET and ZVCHG FET are turned off if *DF:Operation Cfg A* [ZVCHG1, ZVCHG0] are set appropriately. Also, *SBS.ChargingCurrent()* and *SBS.ChargingVoltage()* are set to 0, and *SBS.BatteryStatus()* [TCA, OCA] are set.

There are three recovery methods from this fault state:

1. If *DF:Operation Cfg B* [NR] = 0, AND a transition input of  $\overline{\text{PRES}}$  from low-to-high-to-low (pack removal and re-insertion) occurs, the bq20z80 recovers from this fault mode.
2. If *DF:Operation Cfg B* [NR] = 1 AND *SBS.Current()* is  $\leq 0$  mA, AND there has been *DF:Over Charge Recovery* amount of continuous discharge, the bq20z80 recovers from this fault mode.
3. If *SBS.RemainingStateOfCharge%()* becomes  $\leq \text{DF:FC Clear \%}$ , the bq20z80 recovers from this fault mode.

On recovery, the CHG and ZVCHG FETs are returned to the previous state in accordance with the charging algorithm, and *DF:Operation Cfg A* [ZVCHG1, ZVCHG0], *SBS.BatteryStatus()* [TCA, FC, OCA], and *SBS.ChargingStatus()* [OC] are cleared.

NAME	CLASS / SUBCLASS	FORMAT	VALID RANGE	SIZE (BYTES)	UNITS	DEFAULT VALUE
Over Charge Capacity	Charging Control / Charging Faults (38)	Integer	0 to 4000	2	mAh	300
Over Charge Recovery			0 to 1000	2		2

### Fast Charge Mode Charging Timeout

When *SBS.Current()* is  $\geq \text{DF:Chg Current Threshold}$ , the bq20z80 starts the Fast Charge timer.

The Fast Charge Timer is suspended when *SBS.ChargingStatus()* [PULSEOFF] = 1 or *SBS.ChargingStatus()* [FCHG] = 0, or when *SBS.BatteryStatus()* [DSG] = 1, or when the fast charge timer expires.

The Fast Charge Timer is reset when *DF:Over Charge Recovery* amount of discharge is detected, OR if *DF:Operation Cfg B* [NR] = 1, AND  $\overline{\text{PRES}}$  transitions from low-to-high-to-low.

The bq20z80 sets *SBS.ChargingStatus()* [FCMTO] if the fast charge timer  $\geq \text{DF:FC-MTO}$ , then if *DF:Charge Fault Cfg* [XFCMTO] is set, then the CHG FET is turned off, and the ZVCHG FET is turned OFF if *DF:Operation Cfg A* [ZVCGH1, ZVCHG0] are set appropriately. Also, *SBS.ChargingCurrent()* and *SBS.ChargingVoltage()* are set to 0, and *SBS.BatteryStatus()* [TCA] is set. If *DF:FC-MTO* is programmed to 0, this feature is completely disabled.

To recover from this mode, *SBS.Current()* must be  $\geq (-) \text{DF:Dsg Current Threshold}$  or if *DF:Operation Cfg B* [NR] = 0 AND  $\overline{\text{PRES}}$  transitions from low-to-high-to-low. On recovery, the *SBS.ChargingCurrent()*, *SBS.ChargingVoltage()* and the CHG and ZVCHG FETs are returned to the previous state in accordance with the charging algorithm, and *DF:Operation Cfg A* [ZVCHG1, ZVCHG0], *SBS.BatteryStatus()* [TCA], and *SBS.ChargingStatus()* [FCMTO] are cleared.

NAME	CLASS / SUBCLASS	FORMAT	VALID RANGE	SIZE (BYTES)	UNITS	DEFAULT VALUE
FC-MTO	Charging Control / Charging Faults (38)	Integer	0 to 65535	2	s	10800

### Precharge Mode Charging Timeout

When *SBS.Current()* is  $\geq \text{DF:Chg Current Threshold}$  the bq20z80 starts the Precharge Timer.

The Precharge Timer is suspended when pulse charging is active (*SBS.ChargingStatus()* [PULSEOFF] = 1), and when *SBS.ChargingStatus()* [PCHG] = 0).

The bq20z80 sets *SBS.ChargingStatus( ) [PCMTO]* if the Pre-Charge Timer  $\geq$  *DF:PC-MTO*, and if *DF:Charge Fault Cfg [XPCMTO]* is set, then the CHG FET is turned off, and the ZVCHG FET is turned off if *DF:Operation Cfg A [ZVCHG1, ZVCHG0]* are set appropriately. Also, *SBS.ChargingCurrent( )* and *SBS.ChargingVoltage( )* are set to 0, and *SBS.BatteryStatus( ) [TCA]* is set. If *DF:PC-MTO* is programmed to 0, this feature is completely disabled.

To recover from this mode, *SBS.Current( )* must be  $\geq$  (-) *DF:Dsg Current Threshold*, or if *DF:Operation Cfg B [NR] = 0* AND  $\overline{\text{PRES}}$  transitions from low-to-high-to-low. On recovery, the *SBS.ChargingCurrent( )*, *SBS.ChargingVoltage( )* and the CHG and ZVCHG FETs are returned to the previous state in accordance with the charging algorithm, *SBS.BatteryStatus( ) [TCA]* and *SBS.ChargingStatus( ) [PCMTO]* are cleared.

NAME	CLASS / SUBCLASS	FORMAT	VALID RANGE	SIZE (BYTES)	UNITS	DEFAULT VALUE
PC-MTO	Charging Control / Charging Faults (38)	Integer	0 to 65,535	2	s	3600

## POWER MODE

The bq20z80 has several power modes. During these modes, the bq20z80 modifies its operation to minimize power consumption from the battery.

During normal operation, the bq20z80 takes *ADC.Current*, *ADC.Voltage*, and *ADC.Temperature* measurements, performs calculations, updates SBS data, and makes protection and status decisions at one-second intervals. Between these periods of activity, the bq20z80 is in a reduced power state.

$\overline{\text{PRES}}$  is detected during the measurement period, where the PU pin is pulled high, the  $\overline{\text{PRES}}$  input state is read, and PU is released. If  $\overline{\text{PRES}}$  is high, *SBS.OperationStatus( ) [PRES]* is cleared. If  $\overline{\text{PRES}}$  is low, *SBS.OperationStatus( ) [PRES]* is set indicating the system is present (the battery is inserted).

If *DF:Operation Cfg B [NR]* is set, the  $\overline{\text{PRES}}$  input can be left floating as it is not monitored.

### Normal Mode Discharge Fault – Current

The bq20z80 reports a Normal Mode Discharge fault due to Current by setting *SBS.OperationStatus( ) [XDSGI]* any *SBS.SafetyStatus( ) [OCD, OCD2, AOCD, ASCD]* is set. Also, *SBS.ChargingCurrent( )* and *SBS.BatteryStatus( ) [TCA]* are changed according to *SBS.SafetyStatus( )* flag.

When all of *SBS.SafetyStatus( ) [OCD, OCD2, AOCD, ASCD]* are cleared, *SBS.BatteryStatus( ) [TDA]* and *SBS.OperationStatus( ) [XDSGI]* are also cleared.

### Sleep Mode

In Sleep mode, the bq20z80 measures *ADC.Voltage* and *ADC.Temperature* every *DF:Sleep Voltage Time* interval, and *ADC.Current* is measured at intervals of *DF:Sleep Current Time*. At each interval, the bq20z80 performs calculations, updates SBS data and makes protection and status decisions. Between these periods of activity, the bq20z80 is in a reduced-power state.

The bq20z80 enters Sleep mode when the following conditions exist.

- *SBS.Current( )* in charge or discharge is  $\leq$  *DF:Sleep Current*, AND SMBus is Low for *DF:Bus Low Time*, AND *DF:Operation Cfg A [SLEEP]* is set  
OR
- *SBS.Current( )* is  $\leq$  *DF:Sleep Current* in discharge, AND *SBS.ManufacturerAccess( )* Sleep command is received, AND *DF:Operation Cfg A [SLEEP]* is set.  
AND
- If *DF:Operation Cfg B [NR]* is cleared, the  $\overline{\text{PRES}}$  input must also be high, *SBS.OperationStatus( ) [PRES] = 0*, for the bq20z80 to enter sleep.

Entry to Sleep mode is blocked if any of *SBS.SafetyStatus( ) [OCD, OCC, OCD2, OCC2, PF, AOCD, ASCD]* are set, or if any protection-feature recovery timers are active and have not expired, or if *DF:Sleep Voltage Time = 0* or *DF:Sleep Current Time = 0*, sleep mode is not entered, and the bq20z80 remains in Normal mode.



On entry to sleep, and if *DF:Operation Cfg B [NR]* is cleared, the CHG and DSG FETs are turned off, and the ZVCHG FET is turned off if *DF:Operation Cfg A [ZVCHG1, ZVCHG0]* are set appropriately. If *DF:Operation Cfg B [NR]* is set, the CHG FET is turned off, and the ZVCHG FET is turned off if *DF:Operation Cfg A [ZVCHG1, ZVCHG0]* are set appropriately. However, if *DF:Operation Cfg B [NRCHG]* is set then the CHG remains on.

Also, on entry to Sleep mode, the auto calibration of the ADC begins. However, if *SBS.Temperature( )* is  $\leq$  *DF:Cal Inhibit Temp Low* and  $\geq$  *DF:Cal Inhibit Temp High*, Auto Calibration of the ADC is not started on entry to sleep mode. The activation of auto calibration is not affected by the state of *DF:Operation Cfg A [SLEEP]*, nor *DF:Sleep Voltage Time*, nor *DF:Sleep Current Time* nor *SBS.Current( )*.

The bq20z80 exits Sleep mode if *|SBS.Current( )* is nonzero, OR the SMBC or the SMBD input transitions high, OR any *SBS.OperationStatus( )*, *SBS.ChargingStatus( )*, or *SBS.SafetyStatus( )* flags change state.

If *DF:Operation Cfg B [NR]* is cleared, the bq20z80 exits Sleep mode when  $\overline{\text{PRES}}$  is pulled low (*SBS.OperationStatus( ) [PRES] = 1*).

NAME	CLASS / SUBCLASS	FORMAT	VALID RANGE	SIZE (BYTES)	UNITS	DEFAULT VALUE
Sleep Current	Power / Power (68)	Integer	0 to 100	1	mA	10
Sleep Voltage Time			0 to 100	1	s	5
Sleep Current Time			0 to 255	1	s	20
Bus Low Time			0 to 255	1	s	5
Cal Inhibit Temp High		Signed Int	-400 to 1200	2	0.1°C	50
Cal Inhibit Temp Low			-400 to 1200	2	0.1°C	450

### Battery Removed Mode

The bq20z80 detects the Battery-Removed state when *DF:Operation Cfg B [NR]* is cleared AND the  $\overline{\text{PRES}}$  input is high (*SBS.Operation Status( ) [PRES] = 0*).

On entry to Battery-Removed state, *SBS.BatteryStatus( ) [TCA, TDA]* are set, *SBS.ChargingCurrent( )* and *SBS.ChargingVoltage( )* are set to 0, and the CHG and DSG FETs are turned off, and the ZVCHG FET is turned off if *DF:Operation Cfg A [ZVCHG1, ZVCGH0]* are set appropriately.

Polling of the  $\overline{\text{PRES}}$  pin continues at a rate of once every 1 s.

The bq20z80 exits the Battery-Removed state if *DF:Operation Cfg B [NR]* is cleared, AND the  $\overline{\text{PRES}}$  input is low (*SBS.OperationStatus( ) [PRES] = 1*). When this occurs, *SBS.BatteryStatus( ) [TCA, TDA]* are reset.

### Shutdown Mode

The bq20z80 enters Shutdown mode if the following conditions are met:

- *SBS.Voltage( )*  $\leq$  *DF:Shutdown Voltage* AND *SBS.Current( )*  $\leq$  0  
OR
- (*SBS.ManufacturerAccess( )* shutdown command received AND *SBS.Current( ) = 0*) AND Voltage at the bq29312A Pack pin < *DF:Charger Present* threshold.

If *DF:Operation Cfg B [NR]*, is set, *DF:Charger Present* must be > *DF:Shutdown Voltage* + 6% for correct operation.

It is also recommended that the value of *DF:Charger Present* be > 4.3 V x the number of series cells regardless of the setting of *DF:Operation Cfg B [NR]*.

When the bq20z80 meets these conditions, the CHG, DSG, and ZVCHG FETs are turned off, and the bq29312A is commanded to shut down. In Shutdown mode, the bq20z80 is completely powered down because its supply is removed.

To exit Shutdown mode, the voltage at the PACK pin of the bq29312A must be greater than its minimum operating voltage. When this occurs, the bq29312A returns power to the bq20z80, *SBS.OperationStatus( ) [WAKE]* is set and the bq29312A configured. The *SBS.BatteryMode( ) [INIT]* and *SBS.OperationStatus( ) [WAKE]* are cleared after approximately 1 s when all SBS parameters have been measured and updated.

NAME	CLASS / SUBCLASS	FORMAT	VALID RANGE	SIZE (BYTES)	UNITS	DEFAULT VALUE
Shutdown Voltage	Power / Power (68)	Integer	5000 to 20000	2	mV	7000
Shutdown Time			0 to 60	1	s	10
Charger Present			0 to 23000	2	mV	16800

## Display

### Configuration

#### Number of LEDs Supported

DF:Operation Cfg A [LED1, LED0] determine the number of LEDs supported.

LED1	LED0	LEDs SUPPORTED
0	0	User <sup>(1)</sup>
0	1	3
1	0	4
1	1	5

(1) When *User* configuration selected, the LEDs are controlled as shown in the Display Format tables.

#### NOTE:

At power up, DF:Operation Cfg A [LED1, LED0] are read, the associated *DSG Thresh x* and *CHG Thresh x* thresholds are set per the tables in the *Display Format - Discharge* and *Display Format - Charge* sections.

### Display Type

If DF:Operation Cfg A [SLED] = 0, then the LEDs are controlled as a parallel configuration display. However, if DF:Operation Cfg A [SLED] = 1, then the LEDs are controlled as a series-configuration display and the permanent failure display is disabled.

The serial LED option can be used to implement a much brighter display at the expense of additional hardware components. With the normal connection, the 3.3 V output from the bq29312A is used to power the LEDs. Using that approach, current in each LED should be limited to 3 mA maximum. With the serial option (DF:Operation Cfg A [SLED] = 1), all LEDs can be powered from the battery voltage and driven in series through a simple constant current regulator. The current is then diverted to ground at the various nodes between the series LEDs in order to program the desired pattern.

### Display Mode

The mode of the display is set in DF:Operation Cfg A [DMODE].

DMODE	LEDs SUPPORTED	% DATA	FULL REFERENCE
0	Relative Mode (default)	<i>SBS.RelativeStateOfCharge( )</i>	<i>SBS.DesignCapacity( )</i>
1	Absolute Mode	<i>SBS.AbsoluteStateOfCharge( )</i>	<i>SBS.FullChargeCapacity( )</i>

### Display Format - Discharge

This mode is available when *SBS.BatteryStatus()* [DSG] = 1

LED	THRESHOLD	3-LEDs	4-LEDs	5-LEDs	USER
<b>ALARM</b>	<b>DSG FLASH ALARM</b>	<b>10%</b>	<b>10%</b>	<b>10%</b>	<b>DSG FLASH ALARM</b>
1	<i>SBS.RSOC%</i> ( ) ≥ DSG Thresh 1	0 to 33%	0 to 24%	0 to 19%	<i>SBS.RSOC%</i> ( ) ≥ <i>DF:DSG Thresh 1</i>
2	<i>SBS.RSOC%</i> ( ) ≥ DSG Thresh 2	34 to 66%	25 to 49%	20 to 39%	<i>SBS.RSOC%</i> ( ) ≥ <i>DF:DSG Thresh 2</i>
3	<i>SBS.RSOC%</i> ( ) ≥ DSG Thresh 3	67 to 100%	50 to 74%	40 to 59%	<i>SBS.RSOC%</i> ( ) ≥ <i>DF:DSG Thresh 3</i>
4	<i>SBS.RSOC%</i> ( ) ≥ DSG Thresh 4	–	75 to 100%	60 to 79%	<i>SBS.RSOC%</i> ( ) ≥ <i>DF:DSG Thresh 4</i>
5	<i>SBS.RSOC%</i> ( ) ≥ DSG Thresh 5	–	–	80 to 100%	<i>SBS.RSOC%</i> ( ) ≥ <i>DF:DSG Thresh 5</i>

The DSG Thresh x threshold is the % of *SBS.RelativeStateOfCharge()* or *SBS.AbsoluteStateOfCharge()* to enable the respective LED.

The DSG Flash Alarm threshold is the % of *SBS.RelativeStateOfCharge()* or *SBS.AbsoluteStateOfCharge()* at which the remaining active LEDs flash at a 50% duty-cycle rate of *DF:LED Flash Rate*.

If *DF:Operation Cfg A [LEDRCA]* AND *SBS.BatteryStatus()* [RCA] are set, the display flashes at the *DF:LED Flash Rate* with a 50% duty cycle.

If *DF:Operation Cfg A [LED1, LED0]* = User, the User data flash percentages are used and the values are defined within the range indicated in the Display Timing table.

When *DF:Operation Cfg A [LEDRCA]* = 0, the *SBS.BatteryStatus()* [RCA] is ignored.

### Display Format - Charge

This mode is available when *SBS.BatteryStatus()* DSG = 0

LED	THRESHOLD	3-LEDs	4-LEDs	5-LEDs	USER
<b>ALARM</b>	<b>CHG Flash Alarm</b>	<b>10%</b>	<b>10%</b>	<b>10%</b>	<b>CHG Flash Alarm</b>
1	<i>SBS.RSOC%</i> ( ) ≥ CHG Thresh 1	0 to 33%	0 to 24%	0 to 19%	<i>SBS.RSOC%</i> ( ) ≥ <i>DF:CHG Thresh 1</i>
2	<i>SBS.RSOC%</i> ( ) ≥ CHG Thresh 2	34 to 66%	25 to 49%	20 to 39%	<i>SBS.RSOC%</i> ( ) ≥ <i>DF:CHG Thresh 2</i>
3	<i>SBS.RSOC%</i> ( ) ≥ CHG Thresh 3	67 to 100%	50 to 74%	40 to 59%	<i>SBS.RSOC%</i> ( ) ≥ <i>DF:CHG Thresh 3</i>
4	<i>SBS.RSOC%</i> ( ) ≥ CHG Thresh 4	–	75 to 100%	60 to 79%	<i>SBS.RSOC%</i> ( ) ≥ <i>DF:CHG Thresh 4</i>
5	<i>SBS.RSOC%</i> ( ) ≥ CHG Thresh 5	–	–	80 to 100%	<i>SBS.RSOC%</i> ( ) ≥ <i>DF:CHG Thresh 5</i>

The CHG Thresh x threshold is the % of *SBS.RelativeStateOfCharge()* or *SBS.AbsoluteStateOfCharge()* to enable the respective LED.

During charging the top LED segment flashes at the rate or *DF:LED Blink Rate* (eg: if *SBS.RelativeStateOfCharge()* = 36% and 5 LEDs are being used then LED2 will blink).

The CHG Flash Alarm threshold is the % of *SBS.RelativeStateOfCharge()* or *SBS.AbsoluteStateOfCharge()* at which the remaining active LEDs flash at the rate of *DF:LED Flash Rate*, with a 50% duty cycle.

If *DF:Operation Cfg A [LEDRCA]* AND *SBS.BatteryStatus()* [RCA] are set, the display flashes at the *DF:LED Flash Rate* with a 50% duty cycle.

If *DF:Operation Cfg A [LED1, LED0]* = user, the user data flash percentages are used and the values are defined within the range indicated in the Display Timing table.

**Display Format - Permanent Failure**

This mode is available when  $SBS.SafetyStatus( ) [PF] = 1$ . The LEDs indicate the permanent failure cause as indicated by the flag in  $SBS.PFStatus( )$  and by illuminating LED1 at the *DF:LED Flash Rate* with a 50% duty cycle.

<b>SBS.PFStatus( )</b>	<b>LED3</b>	<b>LED2</b>	<b>LED1</b>
No PF Fault	Blink	0	0
PFIN	Blink	1	0
SOV	Blink	Flash	0
SOTC	Blink	0	1
SOTD	Blink	1	1
CIM	Blink	Flash	1
CFETF	Blink	0	Flash
DFETF	Blink	1	Flash
DFF	Blink	Flash	Flash
AFE_C	0	Blink	0
AFE_P	1	Blink	0
SOCC	Flash	Blink	0
SOCD	0	Blink	1
SOPT	1	Blink	1
RSVD	Flash	Blink	1
RSVD	0	Blink	Flash
FBF	1	Blink	Flash

### Display Timing

When the display is activated, between each active LED illumination there is a delay time of *DF:LED Delay*.

When all active LEDs are illuminated, the display remains active for *DF:LED Hold* time. When this time expires, all LEDs turn off at the same time.

NAME	CLASS / SUBCLASS	FORMAT	VALID RANGE	SIZE (BYTES)	UNITS	DEFAULT VALUE		
LED Flash Rate	LED Support / LED Cfg (67)	Signed Int	1 to 65535	2	ms	500		
LED Blink Rate						1000		
LED Delay						100		
LED Hold Time						4		
CHG Thresh 1			0 to 255	%	0 to 101	1	%	0
CHG Thresh 2								20
CHG Thresh 3								40
CHG Thresh 4								60
CHG Thresh 5								80
DSG Thresh 1								0
DSG Thresh 2								20
DSG Thresh 3								40
DSG Thresh 4								60
DSG Thresh 5								80
CHG Flash Alarm			0 to 101	%	0 to 101	1	%	10
DSG Flash Alarm								10

### Display Activation

There are 4 methods of display activation.

1. *SBS.ManufacturerAccess( )* commands – See the *SBS.ManufacturerAccess( )* section for details.
2. If *DF:Operation Cfg A [LEDR]* is set, the display is activated on exit from reset.
3. If *DF:Operation Cfg A [CHGLEDR]* is set, while *SBS.Current( )* is > *DF:Chg Current Threshold*, the display remains active.
4. High-to-low logic transition on the  $\overline{\text{DISP}}$  pin. The next high-to-low transition of  $\overline{\text{DISP}}$  is not recognized until *DF:LED Hold* expires.

If *DF:Operation Cfg B [PFD0]* is set, then the Permanent Failure (PF) display can be activated for a further period of  $2 \times \text{DF:LED Hold}$  per each bit set in *SBS.PFStatus( )* in two possible ways depending on *DF:Operation Cfg B [PFD1]*. The PF display is shown after the normal capacity display.

1. If a high-to-low logic transition on the  $\overline{\text{DISP}}$  pin occurs, AND the low-state is held for *DF:LED Hold*, AND *DF:Operation Cfg B [PFD1] = 0*
2. If a high-to-low logic transition on the  $\overline{\text{DISP}}$  pin occurs, AND *DF:Operation Cfg B [PFD1] = 1*.

The display is disabled if either of *SBS.SafetyStatus( ) [CUV, PUV]* are set.

### Application Schematic

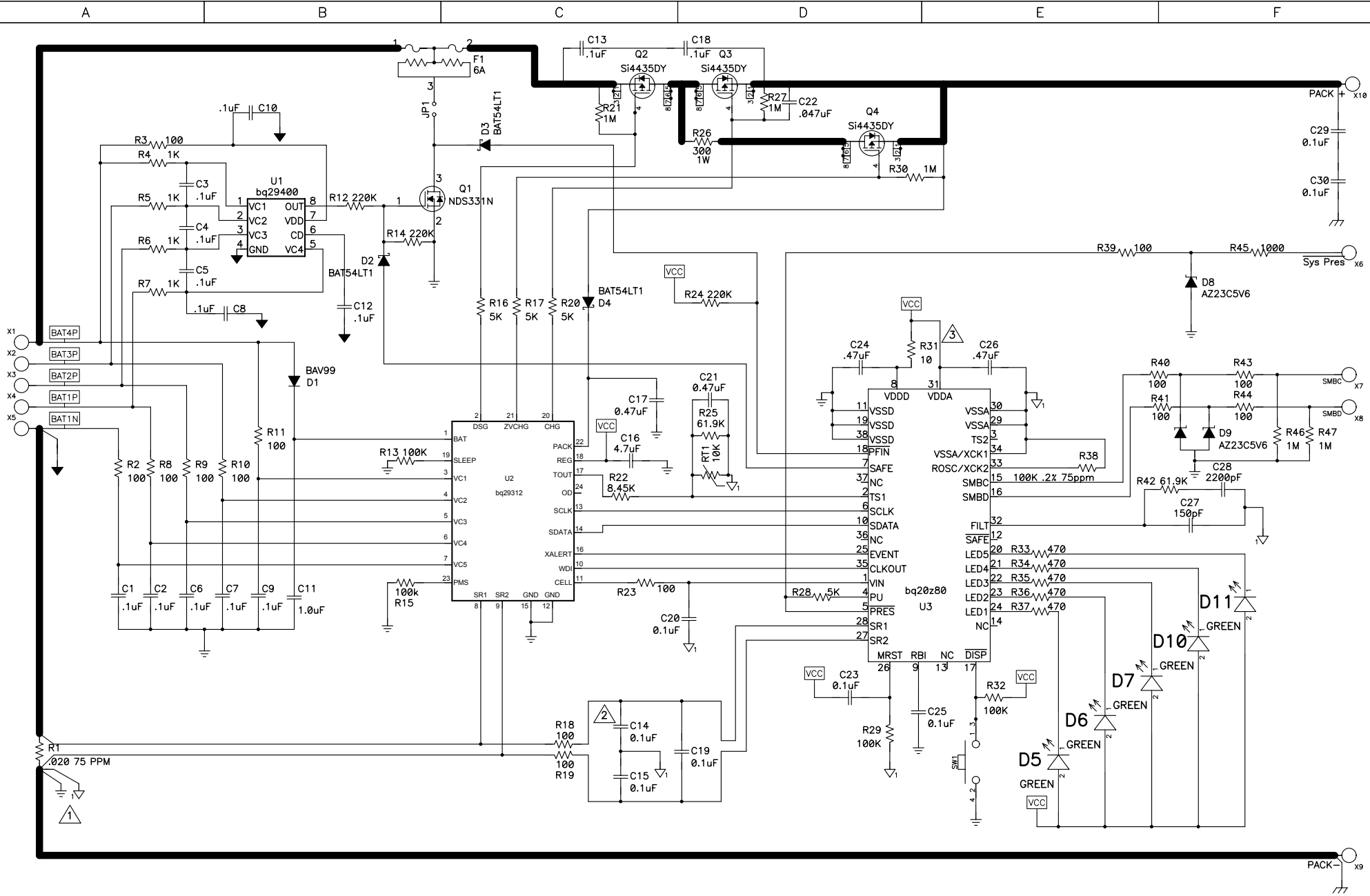

3 Place decoupling caps C24 and C26 VERY close to U3 between pins 8,11 and 31,30 as shown.

2 Place these 5 parts in a symmetric pattern and route traces as a differential pair from the sense resistor to the SR1 and SR2 inputs of the bq2084. R18 and R19 should connect to the sense resistor through traces NOT the ground plane. The length of the route and the actual path (from the sense resistor to the SR1/2 inputs) should be as close to the same as possible-- same number of turns and vias. Place the entire network of resistors and capacitors as close to U3 as possible.

1 Connect Analog and Digital Ground at a single point as close to the ground node of the sense resistor, R1, as possible

Title		
bq20z80 / bq29312 / bq29400		
Size	Number	Rev
C		-
Date	04-26-05	Drawn by DW
Filename	bq20z80 RefDsgn 4 Cells	1 of 1

**PACKAGING INFORMATION**

Orderable Device	Status (1)	Package Type	Package Drawing	Pins	Package Qty	Eco Plan (2)	Lead/Ball Finish (6)	MSL Peak Temp (3)	Op Temp (°C)	Device Marking (4/5)	Samples
BQ20Z80DBT	NRND	TSSOP	DBT	38	50	Green (RoHS & no Sb/Br)	CU NIPDAU	Level-2-260C-1 YEAR	-40 to 85	20Z80DBT	
BQ20Z80DBT-V101	OBSOLETE	TSSOP	DBT	38		TBD	Call TI	Call TI	-40 to 85	20Z80DBT	
BQ20Z80DBT-V101G4	OBSOLETE	TSSOP	DBT	38		TBD	Call TI	Call TI	-40 to 85		

(1) The marketing status values are defined as follows:

**ACTIVE:** Product device recommended for new designs.

**LIFEBUY:** TI has announced that the device will be discontinued, and a lifetime-buy period is in effect.

**NRND:** Not recommended for new designs. Device is in production to support existing customers, but TI does not recommend using this part in a new design.

**PREVIEW:** Device has been announced but is not in production. Samples may or may not be available.

**OBSOLETE:** TI has discontinued the production of the device.

(2) Eco Plan - The planned eco-friendly classification: Pb-Free (RoHS), Pb-Free (RoHS Exempt), or Green (RoHS & no Sb/Br) - please check <http://www.ti.com/productcontent> for the latest availability information and additional product content details.

**TBD:** The Pb-Free/Green conversion plan has not been defined.

**Pb-Free (RoHS):** TI's terms "Lead-Free" or "Pb-Free" mean semiconductor products that are compatible with the current RoHS requirements for all 6 substances, including the requirement that lead not exceed 0.1% by weight in homogeneous materials. Where designed to be soldered at high temperatures, TI Pb-Free products are suitable for use in specified lead-free processes.

**Pb-Free (RoHS Exempt):** This component has a RoHS exemption for either 1) lead-based flip-chip solder bumps used between the die and package, or 2) lead-based die adhesive used between the die and leadframe. The component is otherwise considered Pb-Free (RoHS compatible) as defined above.

**Green (RoHS & no Sb/Br):** TI defines "Green" to mean Pb-Free (RoHS compatible), and free of Bromine (Br) and Antimony (Sb) based flame retardants (Br or Sb do not exceed 0.1% by weight in homogeneous material)

(3) MSL, Peak Temp. - The Moisture Sensitivity Level rating according to the JEDEC industry standard classifications, and peak solder temperature.

(4) There may be additional marking, which relates to the logo, the lot trace code information, or the environmental category on the device.

(5) Multiple Device Markings will be inside parentheses. Only one Device Marking contained in parentheses and separated by a "~" will appear on a device. If a line is indented then it is a continuation of the previous line and the two combined represent the entire Device Marking for that device.

(6) Lead/Ball Finish - Orderable Devices may have multiple material finish options. Finish options are separated by a vertical ruled line. Lead/Ball Finish values may wrap to two lines if the finish value exceeds the maximum column width.

**Important Information and Disclaimer:** The information provided on this page represents TI's knowledge and belief as of the date that it is provided. TI bases its knowledge and belief on information provided by third parties, and makes no representation or warranty as to the accuracy of such information. Efforts are underway to better integrate information from third parties. TI has taken and continues to take reasonable steps to provide representative and accurate information but may not have conducted destructive testing or chemical analysis on incoming materials and chemicals. TI and TI suppliers consider certain information to be proprietary, and thus CAS numbers and other limited information may not be available for release.

In no event shall TI's liability arising out of such information exceed the total purchase price of the TI part(s) at issue in this document sold by TI to Customer on an annual basis.



# MECHANICAL DATA

DBT (R-PDSO-G38)

PLASTIC SMALL OUTLINE

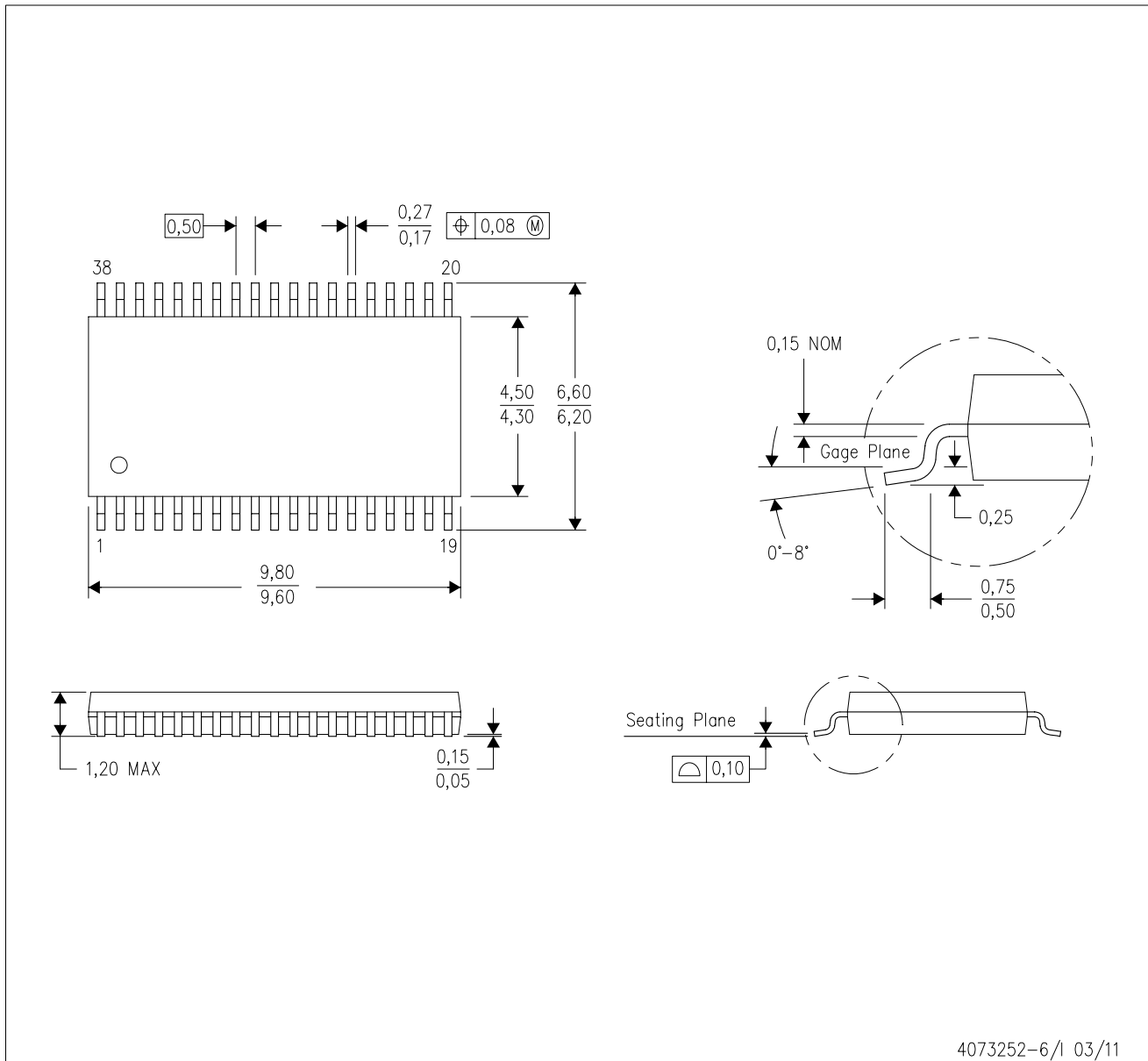

- NOTES:
- All linear dimensions are in millimeters. Dimensioning and tolerancing per ASME Y14.5M-1994.
  - This drawing is subject to change without notice.
  - Body dimensions do not include mold flash or protrusion.
  - Falls within JEDEC MO-153.

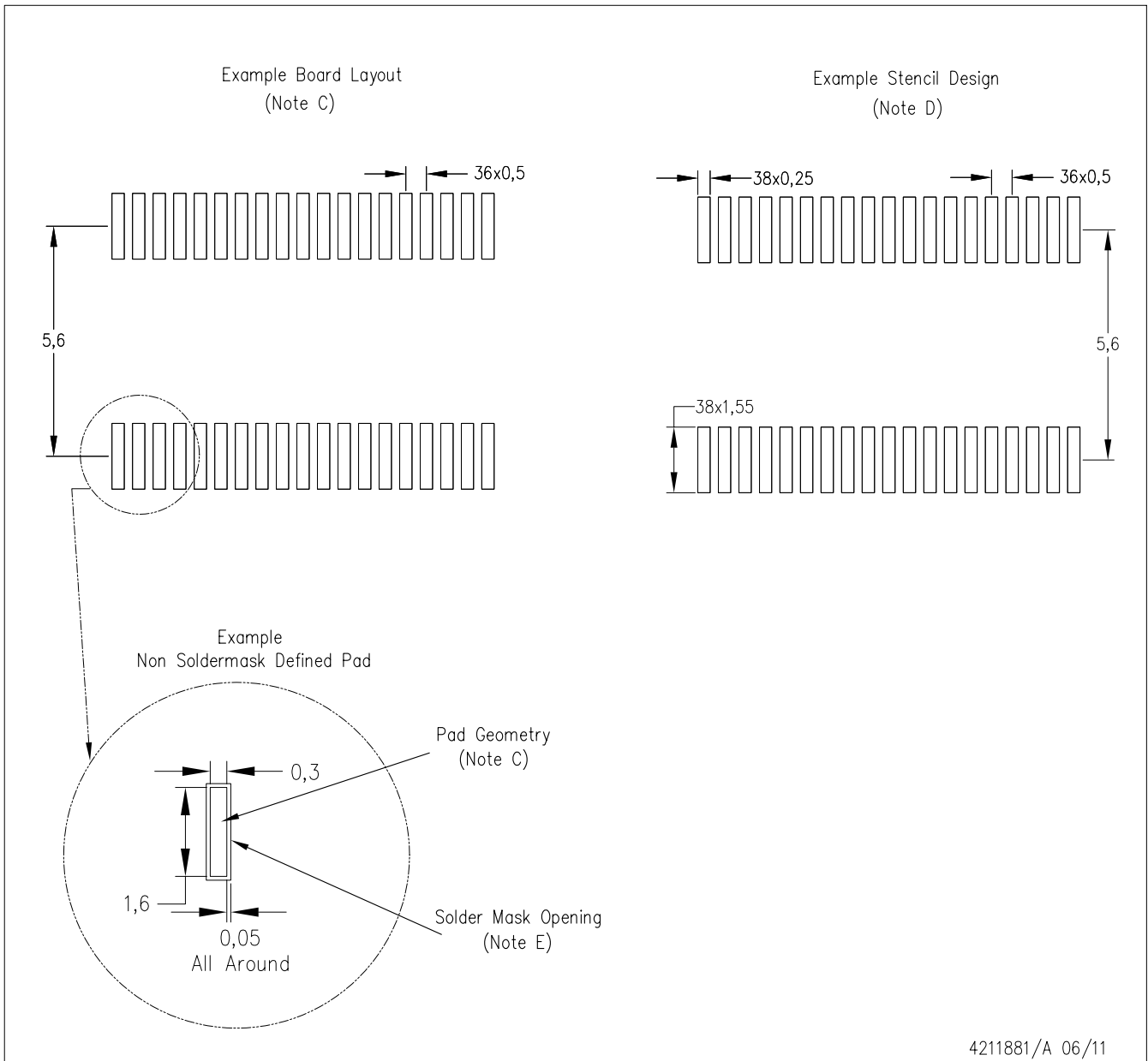

- NOTES:
- A. All linear dimensions are in millimeters.
  - B. This drawing is subject to change without notice.
  - C. Publication IPC-7351 is recommended for alternate designs
  - D. Laser cutting apertures with trapezoidal walls and also rounding corners will offer better paste release. Customers should contact their board assembly site for stencil design recommendations. Refer to IPC-7525.
  - E. Customers should contact their board fabrication site for solder mask tolerances between and around signal pads.

## IMPORTANT NOTICE

Texas Instruments Incorporated and its subsidiaries (TI) reserve the right to make corrections, enhancements, improvements and other changes to its semiconductor products and services per JESD46, latest issue, and to discontinue any product or service per JESD48, latest issue. Buyers should obtain the latest relevant information before placing orders and should verify that such information is current and complete. All semiconductor products (also referred to herein as "components") are sold subject to TI's terms and conditions of sale supplied at the time of order acknowledgment.

TI warrants performance of its components to the specifications applicable at the time of sale, in accordance with the warranty in TI's terms and conditions of sale of semiconductor products. Testing and other quality control techniques are used to the extent TI deems necessary to support this warranty. Except where mandated by applicable law, testing of all parameters of each component is not necessarily performed.

TI assumes no liability for applications assistance or the design of Buyers' products. Buyers are responsible for their products and applications using TI components. To minimize the risks associated with Buyers' products and applications, Buyers should provide adequate design and operating safeguards.

TI does not warrant or represent that any license, either express or implied, is granted under any patent right, copyright, mask work right, or other intellectual property right relating to any combination, machine, or process in which TI components or services are used. Information published by TI regarding third-party products or services does not constitute a license to use such products or services or a warranty or endorsement thereof. Use of such information may require a license from a third party under the patents or other intellectual property of the third party, or a license from TI under the patents or other intellectual property of TI.

Reproduction of significant portions of TI information in TI data books or data sheets is permissible only if reproduction is without alteration and is accompanied by all associated warranties, conditions, limitations, and notices. TI is not responsible or liable for such altered documentation. Information of third parties may be subject to additional restrictions.

Resale of TI components or services with statements different from or beyond the parameters stated by TI for that component or service voids all express and any implied warranties for the associated TI component or service and is an unfair and deceptive business practice. TI is not responsible or liable for any such statements.

Buyer acknowledges and agrees that it is solely responsible for compliance with all legal, regulatory and safety-related requirements concerning its products, and any use of TI components in its applications, notwithstanding any applications-related information or support that may be provided by TI. Buyer represents and agrees that it has all the necessary expertise to create and implement safeguards which anticipate dangerous consequences of failures, monitor failures and their consequences, lessen the likelihood of failures that might cause harm and take appropriate remedial actions. Buyer will fully indemnify TI and its representatives against any damages arising out of the use of any TI components in safety-critical applications.

In some cases, TI components may be promoted specifically to facilitate safety-related applications. With such components, TI's goal is to help enable customers to design and create their own end-product solutions that meet applicable functional safety standards and requirements. Nonetheless, such components are subject to these terms.

No TI components are authorized for use in FDA Class III (or similar life-critical medical equipment) unless authorized officers of the parties have executed a special agreement specifically governing such use.

Only those TI components which TI has specifically designated as military grade or "enhanced plastic" are designed and intended for use in military/aerospace applications or environments. Buyer acknowledges and agrees that any military or aerospace use of TI components which have **not** been so designated is solely at the Buyer's risk, and that Buyer is solely responsible for compliance with all legal and regulatory requirements in connection with such use.

TI has specifically designated certain components as meeting ISO/TS16949 requirements, mainly for automotive use. In any case of use of non-designated products, TI will not be responsible for any failure to meet ISO/TS16949.

### Products

Audio	<a href="http://www.ti.com/audio">www.ti.com/audio</a>
Amplifiers	<a href="http://amplifier.ti.com">amplifier.ti.com</a>
Data Converters	<a href="http://dataconverter.ti.com">dataconverter.ti.com</a>
DLP® Products	<a href="http://www.dlp.com">www.dlp.com</a>
DSP	<a href="http://dsp.ti.com">dsp.ti.com</a>
Clocks and Timers	<a href="http://www.ti.com/clocks">www.ti.com/clocks</a>
Interface	<a href="http://interface.ti.com">interface.ti.com</a>
Logic	<a href="http://logic.ti.com">logic.ti.com</a>
Power Mgmt	<a href="http://power.ti.com">power.ti.com</a>
Microcontrollers	<a href="http://microcontroller.ti.com">microcontroller.ti.com</a>
RFID	<a href="http://www.ti-rfid.com">www.ti-rfid.com</a>
OMAP Applications Processors	<a href="http://www.ti.com/omap">www.ti.com/omap</a>
Wireless Connectivity	<a href="http://www.ti.com/wirelessconnectivity">www.ti.com/wirelessconnectivity</a>

### Applications

Automotive and Transportation	<a href="http://www.ti.com/automotive">www.ti.com/automotive</a>
Communications and Telecom	<a href="http://www.ti.com/communications">www.ti.com/communications</a>
Computers and Peripherals	<a href="http://www.ti.com/computers">www.ti.com/computers</a>
Consumer Electronics	<a href="http://www.ti.com/consumer-apps">www.ti.com/consumer-apps</a>
Energy and Lighting	<a href="http://www.ti.com/energy">www.ti.com/energy</a>
Industrial	<a href="http://www.ti.com/industrial">www.ti.com/industrial</a>
Medical	<a href="http://www.ti.com/medical">www.ti.com/medical</a>
Security	<a href="http://www.ti.com/security">www.ti.com/security</a>
Space, Avionics and Defense	<a href="http://www.ti.com/space-avionics-defense">www.ti.com/space-avionics-defense</a>
Video and Imaging	<a href="http://www.ti.com/video">www.ti.com/video</a>

### TI E2E Community

[e2e.ti.com](http://e2e.ti.com)