

**REGULATORY COMPLIANCE**

 <b>Lead Free</b> COMPLIANT	 <b>EU RoHS</b> 2011/65 + 2015/863 COMPLIANT	 <b>China RoHS</b> COMPLIANT	 <b>REACH</b> <b>SVHC</b> COMPLIANT	 <b>DRC</b> <b>CONFLICT</b> <b>FREE</b>
---	---	---	---	---

**ITEM DESCRIPTION**

Quartz Crystal Resonator 3.5mm x 6.0mm x 1.0mm 4 Pad Ceramic Surface Mount (SMD)

**ELECTRICAL SPECIFICATIONS**

<b>Nominal Frequency</b>	10MHz to 48MHz
<b>Frequency Tolerance/Stability</b>	±50ppm at 25°C, ±100ppm over 0°C to +70°C ±50ppm at 25°C, ±100ppm over -20°C to +70°C ±50ppm at 25°C, ±100ppm over -40°C to +85°C ±30ppm at 25°C, ±50ppm over 0°C to +70°C ±30ppm at 25°C, ±50ppm over -20°C to +70°C ±30ppm at 25°C, ±50ppm over -40°C to +85°C ±15ppm at 25°C, ±30ppm over 0°C to +70°C ±15ppm at 25°C, ±30ppm over -20°C to +70°C ±15ppm at 25°C, ±30ppm over -40°C to +85°C ±15ppm at 25°C, ±20ppm over 0°C to +70°C ±15ppm at 25°C, ±20ppm over -20°C to +70°C ±15ppm at 25°C, ±20ppm over -40°C to +85°C ±10ppm at 25°C, ±15ppm over 0°C to +70°C ±10ppm at 25°C, ±15ppm over -20°C to +70°C ±10ppm at 25°C, ±15ppm over -40°C to +85°C
<b>Aging at 25°C</b>	±3ppm/year Maximum
<b>Load Capacitance</b>	Series Resonant, 10pF Parallel Resonant to 50pF Parallel Resonant
<b>Shunt Capacitance</b>	5pF Maximum
<b>Equivalent Series Resistance</b>	60 Ohms Maximum over Nominal Frequency of 10MHz to 19.999999MHz 50 Ohms Maximum over Nominal Frequency of 20MHz to 34.999999MHz 40 Ohms Maximum over Nominal Frequency of 35MHz to 48MHz
<b>Mode of Operation</b>	AT-Cut Fundamental
<b>Drive Level</b>	100µWatts Maximum
<b>Spurious Response</b>	Measured from Fo to Fo +5000ppm -3dB Minimum
<b>Storage Temperature Range</b>	-40°C to +85°C
<b>Insulation Resistance</b>	Measured at 100Vdc 500 Megaohms Minimum

## PART NUMBERING GUIDE

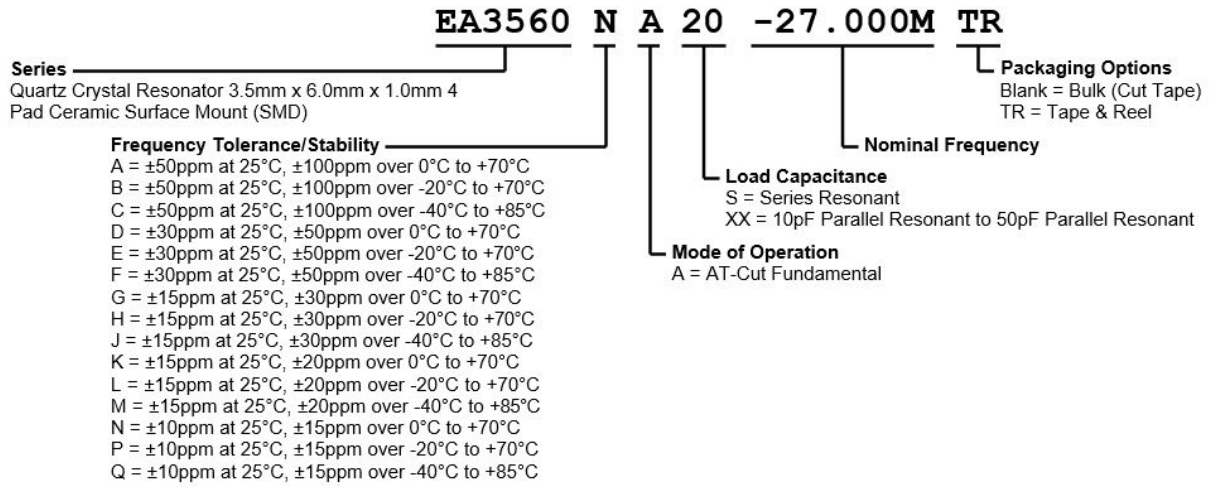

**MECHANICAL DIMENSIONS**

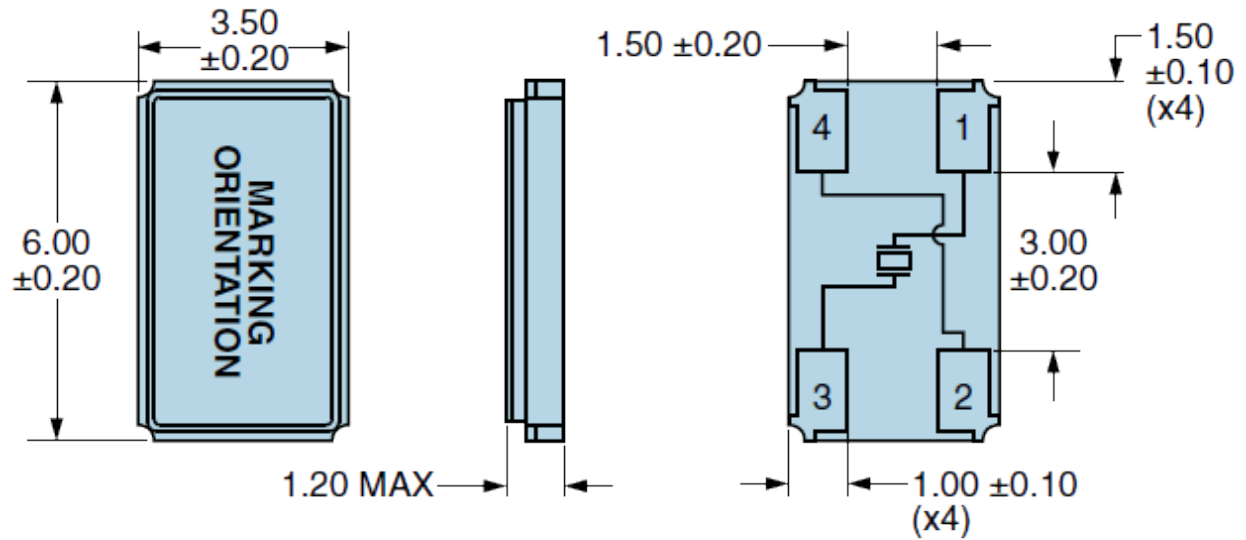

Note: Chamfer not shown.

**Seam Sealed**

**Terminal Plating Thickness:** Gold (0.3 to 1.0 $\mu$ m) over Nickel (1.27 to 8.89 $\mu$ m).

**SUGGESTED SOLDER PAD LAYOUT**

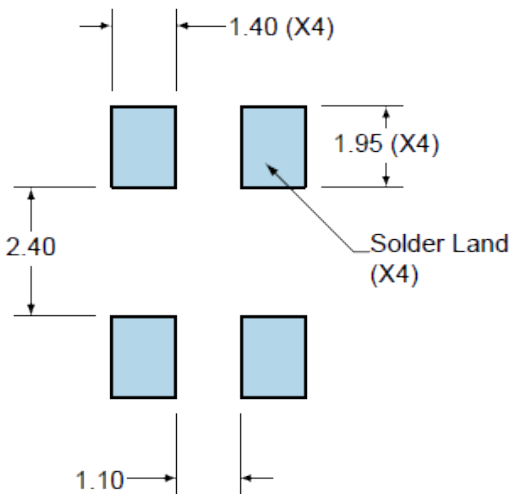

PIN	CONNECTION
1	Crystal
2	Case/Ground
3	Crystal
4	Case/Ground

All Tolerances are  $\pm 0.1$

**All Dimensions in Millimeters**

# EA3560 Series

## TAPE & REEL DIMENSIONS

Quantity per Reel: 1,000 Units

All Dimensions in Millimeters

Compliant to EIA-481

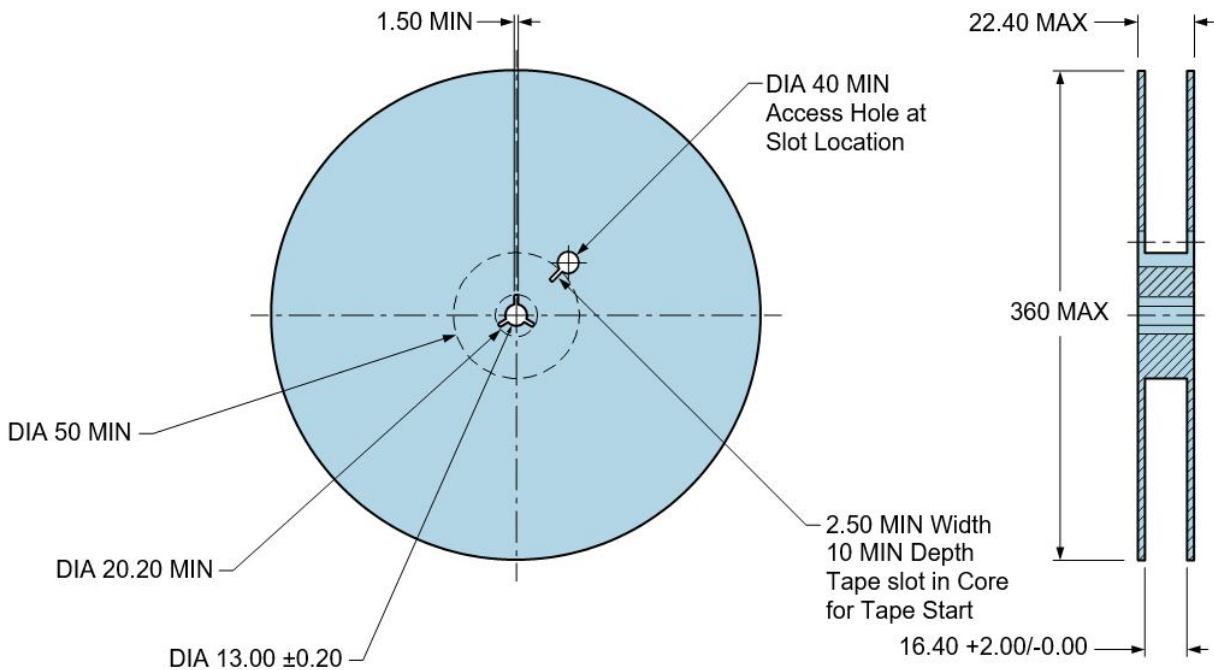
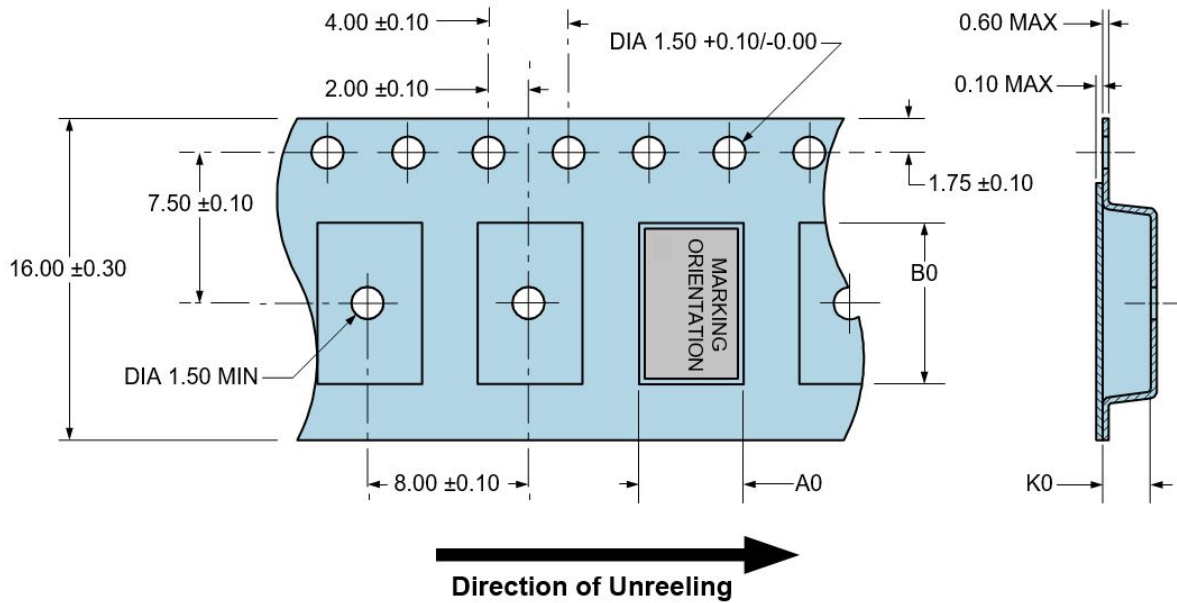

## RECOMMENDED SOLDER REFLOW METHOD

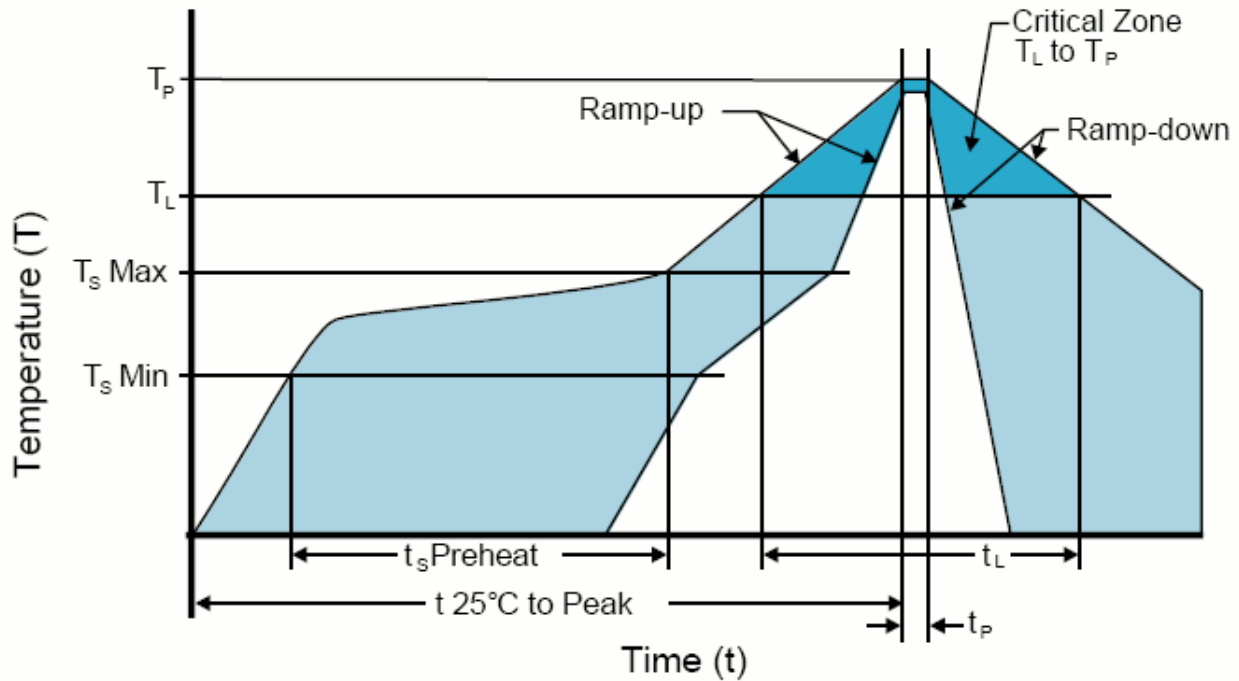

## HIGH TEMPERATURE INFRARED/CONVECTION

$T_S$ MAX to $T_L$ (Ramp-up Rate)	3°C/Second Maximum
<b>Preheat</b>	
- Temperature Minimum ( $T_S$ MIN)	150°C
- Temperature Typical ( $T_S$ TYP)	175°C
- Temperature Maximum ( $T_S$ MAX)	200°C
- Time ( $t_s$ MIN)	60 - 180 Seconds
<b>Ramp-up Rate (<math>T_L</math> to <math>T_P</math>)</b>	3°C/Second Maximum
<b>Time Maintained Above:</b>	
- Temperature ( $T_L$ )	217°C
- Time ( $t_L$ )	60 - 150 Seconds
<b>Peak Temperature (<math>T_P</math>)</b>	260°C Maximum for 10 Seconds Maximum
<b>Target Peak Temperature (<math>T_P</math> Target)</b>	250°C +0/-5°C
<b>Time within 5°C of actual peak (<math>t_p</math>)</b>	20 - 40 Seconds
<b>Ramp-down Rate</b>	6°C/Second Maximum
<b>Time 25°C to Peak Temperature (t)</b>	8 Minutes Maximum
<b>Moisture Sensitivity Level</b>	Level 1
<b>Additional Notes</b>	Temperatures shown are applied to body of device.

## High Temperature Manual Soldering

260°C Maximum for 5 Seconds Maximum, 2 times Maximum. (Temperatures shown are applied to body of device.)

## RECOMMENDED SOLDER REFLOW METHOD

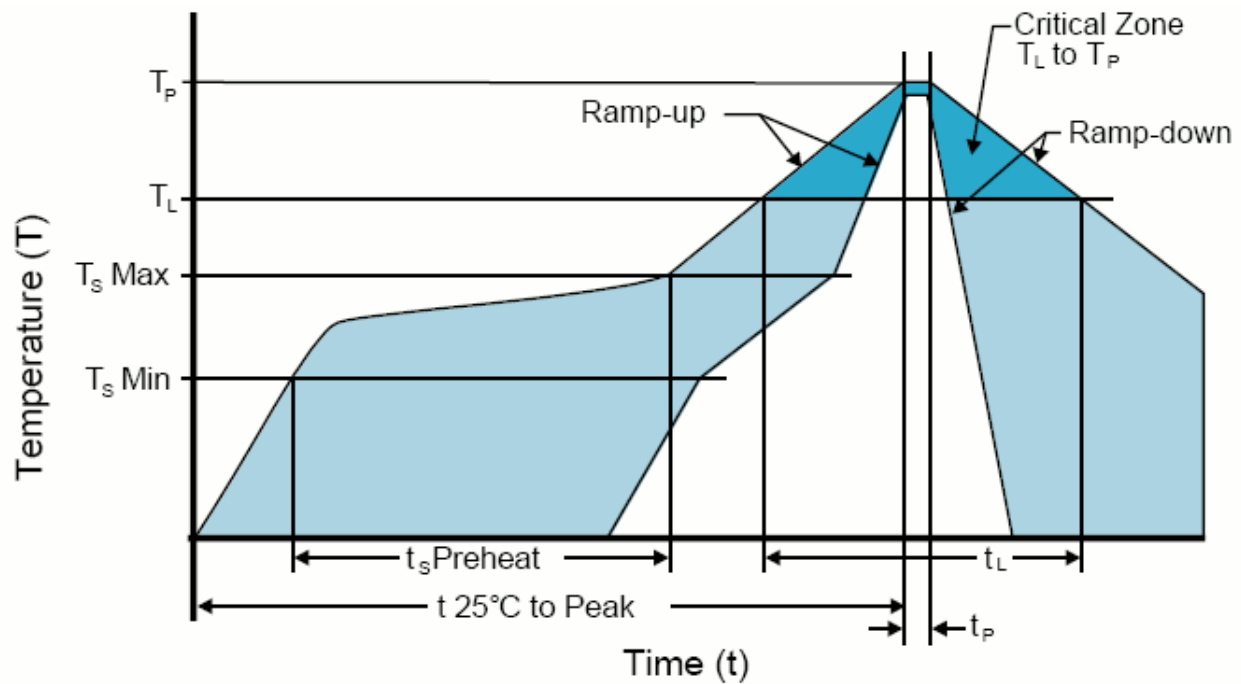

## LOW TEMPERATURE INFRARED/CONVECTION

$T_S \text{ MAX to } T_L$ (Ramp-up Rate)	5°C/Second Maximum
<b>Preheat</b>	
- Temperature Minimum ( $T_S \text{ MIN}$ )	N/A
- Temperature Typical ( $T_S \text{ TYP}$ )	150°C
- Temperature Maximum ( $T_S \text{ MAX}$ )	N/A
- Time ( $t_s \text{ MIN}$ )	30 - 60 Seconds
<b>Ramp-up Rate (<math>T_L</math> to <math>T_P</math>)</b>	5°C/Second Maximum
<b>Time Maintained Above:</b>	
- Temperature ( $T_L$ )	150°C
- Time ( $t_L$ )	200 Seconds Maximum
<b>Peak Temperature (<math>T_P</math>)</b>	245°C Maximum
<b>Target Peak Temperature (<math>T_P \text{ Target}</math>)</b>	245°C Maximum 2 Times / 230°C Maximum 1 Time
<b>Time within 5°C of actual peak (<math>t_p</math>)</b>	10 Seconds Maximum 2 Times / 80 Seconds Maximum 1 Time
<b>Ramp-down Rate</b>	5°C/Second Maximum
<b>Time 25°C to Peak Temperature (t)</b>	N/A
<b>Moisture Sensitivity Level</b>	Level 1
<b>Additional Notes</b>	Temperatures shown are applied to body of device.

## Low Temperature Manual Soldering

185°C Maximum for 10 Seconds Maximum, 2 times Maximum. (Temperatures shown are applied to body of device.)